



High Power Test Systems

Test power supplies

Bidirectional power supplies for testing and simulating batteries, fuel cells, drives and further components.



75 years Gustav Klein

On the occasion of the 75th anniversary of the Gustav Klein company, I would like to express my sincere thanks to all customers, business partners and employees for the many years of successful cooperation.

Since its foundation in 1948 by Gustav Klein, the company has developed into a globally well-positioned manufacturer of power supply systems for industrial applications.

The extensive product portfolio includes test and simulation systems for batteries, fuel cells and drives, uninterruptible power supplies, inverters, rectifiers and frequency converters. Our flexibility enables us to manufacture systems individually according to customer and project-specific requirements.

Experience built up over decades, innovative technology and an outstanding level of quality ensure a long service life and maximum availability of our systems. Renowned companies from the fields of e-mobility, railway technology, medicine, power plant construction, chemistry and energy technology are among our international clientele.

In addition to its headquarters in Schongau, the company has had another production site in Austria since 1969. The complete product range can also be manufactured at our Inzing facility.

In the meantime, we have delivered over 400,000 systems to 105 countries around the world. We are particularly proud of our more than 250 competent, experienced and always committed employees.

With our high-quality products, we are actively contributing to the megatrend of the All Electric Society. We support the mobility turnaround with highly available power supplies and universal test systems for e-mobility. We supply solutions for the development and production of fuel cells, batteries, powertrains and DC highvoltage charging systems to a global customer base.

The wide range of possible applications for our products makes us extremely optimistic about the future. We hope that, together with our customers and business partners, to realise many interesting projects in the future.



Martin Dlauhy
CEO



Günther Stensitzki
President and Owner



Im Forchet, Schongau / Germany



Greifenstraße, Schongau / Germany



Schießstand, Inzing / Austria



75 years Gustav Klein	2
Locations	3
Our quality standard	4
Application examples for test and simulation systems	6
Testing and simulation	10
Accessories for test and simulation systems	12
Overview Gustav Klein test systems	14
Single-Channel System	16
Single-Channel System – overload	20
Multi-Channel System	24
Multi-Channel System – overload	28
Flex-Channel System	32
References	36
History	37
Our services	38



Over

400.000

systems sold in



105

countries

Our quality standards

Gustav Klein has been supplying power supply units and systems for 75 years. The expertise and experience of our qualified employees offer you reliability and competence in solving your specific requirements. Thanks to the continuous further development of our product portfolio, truly safe systems will also be available in the future.

Reliable Power Solutions.

Follow us



Durable system design

- Over 15 years of experience with test systems speak for themselves
- Possibility of subsequent upgrades
- High-quality system components from selected suppliers
- At least 10 years spare parts availability
- Manufactured exclusively in Germany and Austria
- Designed for 24/7 use

Realisation of special customer requirements

- Support from Gustav Klein for pilot projects
- Large selection of options
- Customised adaptations possible

Low follow-up costs

- Service-friendly system design
- No scheduled software updates required
- Long service intervals

Reliable Power Solutions.

First-class service

- Immediate support from GK telephone support (short routes to expertise providers)
- In-house service team supported by qualified partners
- Wide range of services: We are at your side from commissioning to modernisation

Simple and safe use of the devices

- Simple operation: clear visualization and operating via display or PC
- Integrated security: e.g. individualised access levels, warning messages on the display, special locking cylinder, door lock

Application examples for test and simulation systems

Our test power supplies can be used for a wide range of applications. You will find a few application examples below to give you a brief insight.

Test of batteries

- End of line tests
- Long-term test
e.g. according to WLTP
- In the development stage
- For type testing



Testing electrical components & assemblies

- Contactors
- Penthouse
- Switches



Emulation of batteries

- Test of inverters
- Testing of electrical drive trains



Testing of fuel cells

- End of Line Test
- Long-term test
- In the development stage
- For type testing
- For conditioning





Application 1: Testing DC charging stations

For optimal performance and realistic testing of your EV charging systems, our I-TS is the perfect choice. The I-TS simulates the EV batteries for these tests. Integrate the I-TS into your test environment to ensure the reliability and safety of your products and reduce time-to-market.

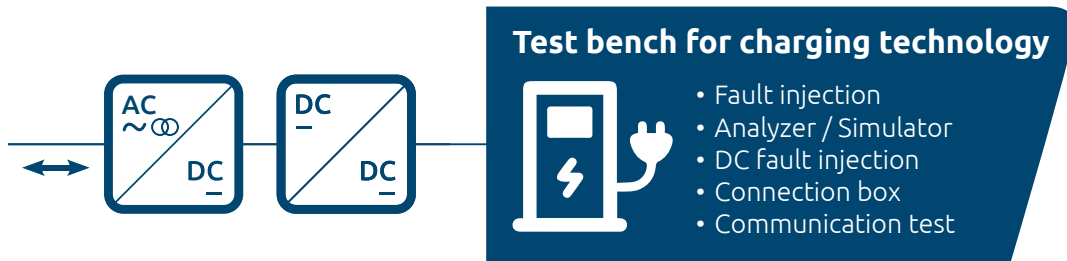

Application 2: Multi-channel system with energy balancing via DC bus

Our innovative multi-channel system MI-TS allows you to test multiple devices at the same time while saving energy to be used efficiently. The energy stored in test item 1 can be passed on directly to test item 2 via the DC converter (back to back). This not only saves energy and costs, but also uses the energy that is already available optimal.

This system is particularly beneficial when your grid connection is limited or when it comes to peak loads in the AC network to be managed effectively. With the MI-TS you can be sure that you are conserving your resources simultaneously carry out efficient and effective tests.

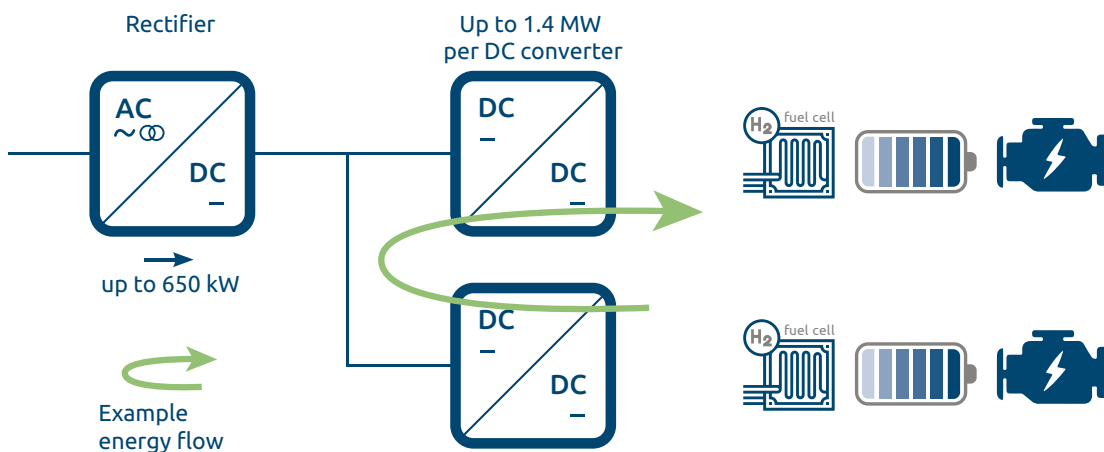

Application 3: Test bench for DC/DC converters

When testing DC/DC converters, the DC channels of the (M)I-TS serve as a source and as a load. DC/DC converters with integrated galvanic isolation can be tested with an MI-TS-3871 with 2 channels. For DC/DC converters without internal galvanic isolation, the I-TS-3872 or two separate I-TS-3870 are suitable for testing.

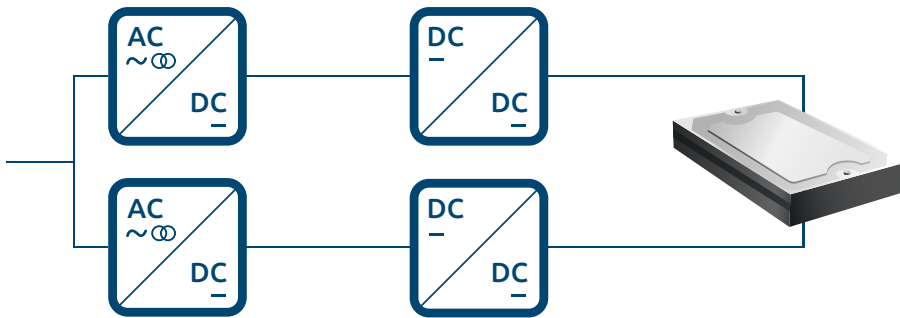

Application 4: Test bench for batteries

Due to the seamless transition between source and sink operation and the high dynamics, the (M)I-TS is suitable for testing batteries as a cycler or for the pulse power test. In the pulse power test, the overload-capable variants in particular show their strengths. Thanks to the various available interfaces (protocols are provided), the (M)I-TS can be integrated into all test benches.

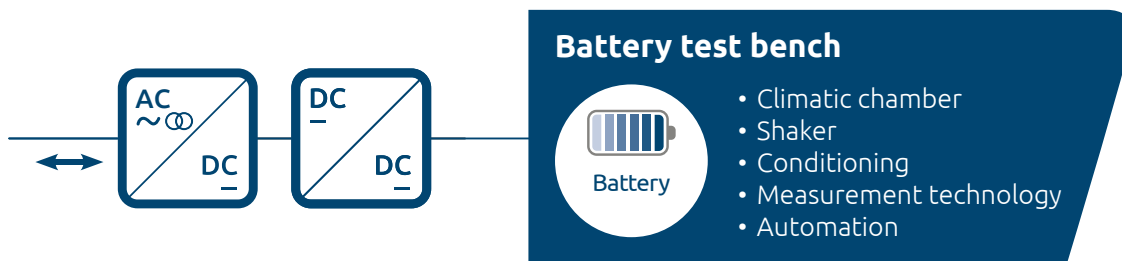

Application 5: Electrical load for fuel cell

The outstanding performance is the basis of the highly dynamic I-TS test system. This includes, in particular, the high load stability with low current ripple. This makes the I-TS the ideal choice for unidirectional load operation in fuel cell applications, and a selectable diode is available as an optional extra to protect the fuel cell in exclusive sink operation.

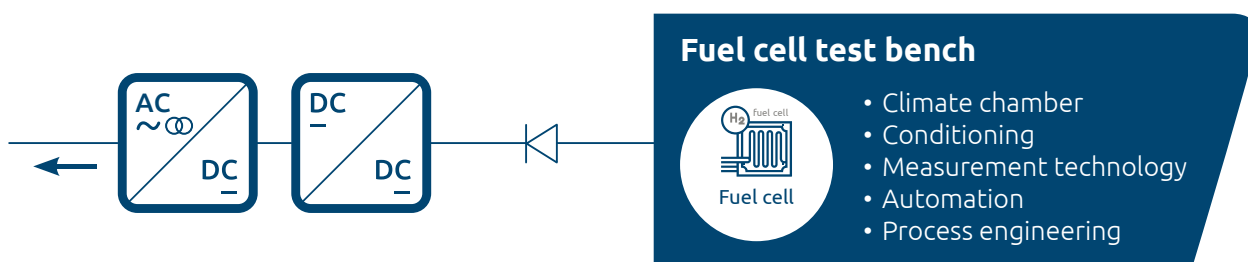

Testing and simulation

Bidirectional power supplies for testing and simulating batteries, fuel cells, drives and further components.

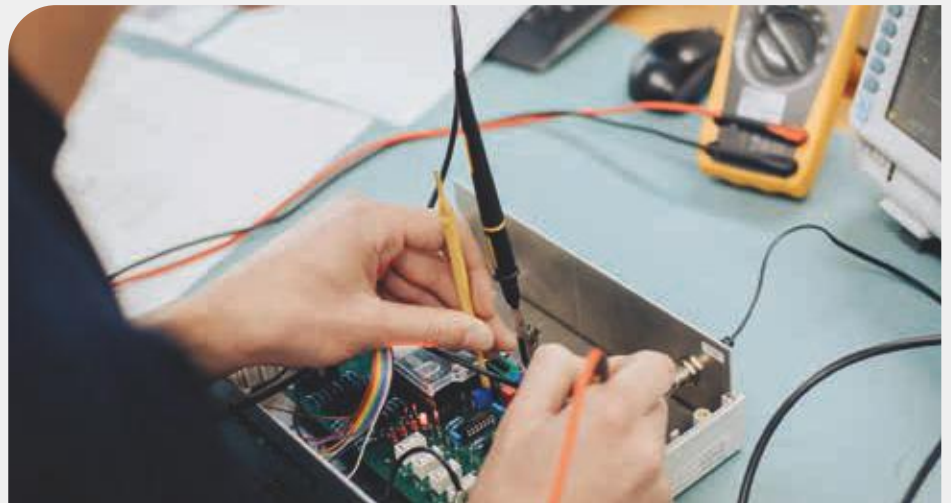

Single-Channel System
DC source/sink: I-TS-3870

Single-channel system for testing and simulating batteries, fuel cells and powertrains. One output with up to 1500 V and 1200 A. Maximum power in single operation 650 kW, up to 2.6 MW in parallel operation. (Maximum values for voltage, current and power depending on the specific configuration).



Multi-Channel System
DC source/sink: MI-TS-3871

Multi-channel system for energy-saving tests and simulations. Two or four outputs, up to 1500 V and 1200 A per output (without galvanic isolation between the DC outputs // Maximum values for voltage, current and number of output channels depending on the specific configuration).



Flex-Channel System DC source/sink: I-TS-3872

State-of-the-art, liquid-cooled DC source / sink. Depending on requirements, the system can be used in single, serial or parallel mode. Voltages of up to 1500 V are possible in serial mode.



Single-Channel System AC source/sink: (R)TS-AC-5445/5446

Adjustable AC source/sink

Rated power up to 200 kVA 1~,
up to 500 kVA 3~
Frequencies from 16.7 to 800 Hz.

Accessories for test and simulation systems

Additional accessories are available to complement and round off our power supplies.



PDSB
(Power distribution switching box)

Control cabinet for parallelizing several DC outputs or for switching a DC output to different test benches. Over 50 different variants are available.



PDU
(Power distribution unit)

Control cabinet for local connection of the test object in the test bench. Additional capacitors and isolating devices can also be integrated here.



Capacitor box



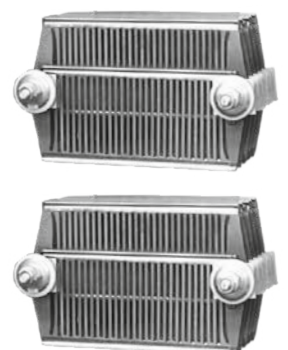





Touch-proof housing with capacitors to stabilize the control loop.





DCU (Discharge Unit)

If the possibility of AC mains recovery is not sufficient, the Discharge Unit offers the possibility of using discharge resistors to reduce the energy of the device under test in the battery emulation.

Gustav Klein test systems

	I-TS-3870 Standard	I-TS-3870-ol overload
Power rating in kW	35, 50, 60, 100, 120, 160 250, 320, 400, 500, 650	60, 100, 160, 250, 320, 400, 500
Power overload capability Performance		
Max. DC output voltage in V	80, 120, 300, 600, 800, 1000, 1200, 1500	600, 800, 1000
Voltage with center point		
Current range in A (per channel)	± 200 ± 600 ± 800 ± 1000 ± 1200	± 200 ± 600 ± 800 ± 1000 ± 1200
Number of DC channels	1	1
Parallel switching capability (flexible)	2 Systems max. 1300 kW max. ± 2400 A	2 Systems max. 1000 kW max. ± 2400 A
Parallel switching capability (rigid)	4 Systems max. 2600 kW max. ± 4800 A	4 Systems max. 2000 kW max. ± 4800 A
Available protection classes	IP20, IP21, IP23, IP54	IP20, IP21, IP23, IP54
Air cooling		
Liquid cooling		
Communication interfaces (standard)	CAN, Modbus TCP, Ethernet, VNC	CAN, Modbus TCP, Ethernet, VNC
Communication interfaces (optional)	Profibus, Profinet, EtherCAT, LabVIEW, Matlab/Simulink	Profibus, Profinet, EtherCAT, LabVIEW, Matlab/Simulink

MI-TS-3871 Standard	MI-TS-3871-ol overload	I-TS-3872 Standard
60, 100, 120, 160, 250, 320, 400, 500, 650	60, 100, 160, 250, 320, 400, 500	300, 600
—	✓	✓
300, 600, 800, 1000, 1200, 1500	600, 800, 1000	2x 750, 1500
—	—	✓
± 200 ± 600 ± 800 ± 1000 ± 1200	± 200 ± 600 ± 800 ± 1000 ± 1200	± 1000 (750 V) ± 1000 (1500 V) ± 2000 (750 V)
2 or 4	2 or 4	1 (1500 V) 2 (750 V)
2 or 4 Channels max. 650 kW max. ± 2400 A (2 Chan.) max. ± 4800 A (4 Chan.)	2 or 4 Channels max. 500 kW max. ± 2400 A (2 Chan.) max. ± 4800 A (4 Chan.)	2 Systems max. 1200 kW max. ± 2000 A (1500 V) max. ± 4000 A (750 V)
2 or 4 Channels max. 650 kW max. ± 2400 A (2 Chan.) max. ± 4800 A (4 Chan.)	2 or 4 Channels max. 500 kW max. ± 2400 A (2 Chan.) max. ± 4800 A (4 Chan.)	2 Systems max. 1200 kW max. ± 4000 A
IP20, IP21, IP23, IP54	IP20, IP21, IP23, IP54	IP54
✓	✓	—
○	○	✓
CAN, Modbus TCP, Ethernet, VNC	CAN, Modbus TCP, Ethernet, VNC	CAN, Modbus TCP, Ethernet, VNC
Profibus, Profinet, EtherCAT, LabVIEW, Matlab/Simulink	Profibus, Profinet, EtherCAT, LabVIEW, Matlab/Simulink	Profibus, Profinet, EtherCAT

-  Standard
-  Optional
-  Not available

Single-Channel System

I-TS-3870

Our high-performance test system I-TS (Infeed test system) is a high dynamic, bidirectional DC power supply with continuous and seamless transition from source to sink operation. The outstanding performance is the basis for a wide range of applications in the automotive, hydrogen and laboratory sectors.



Circuit diagram

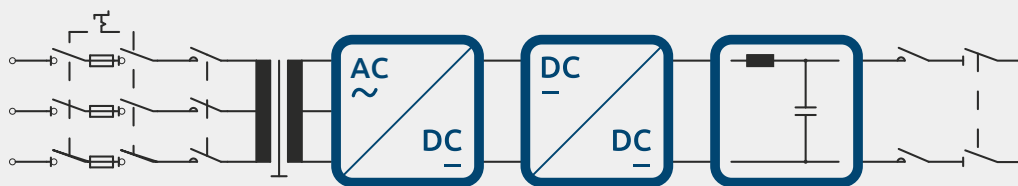

Performance hyperbole

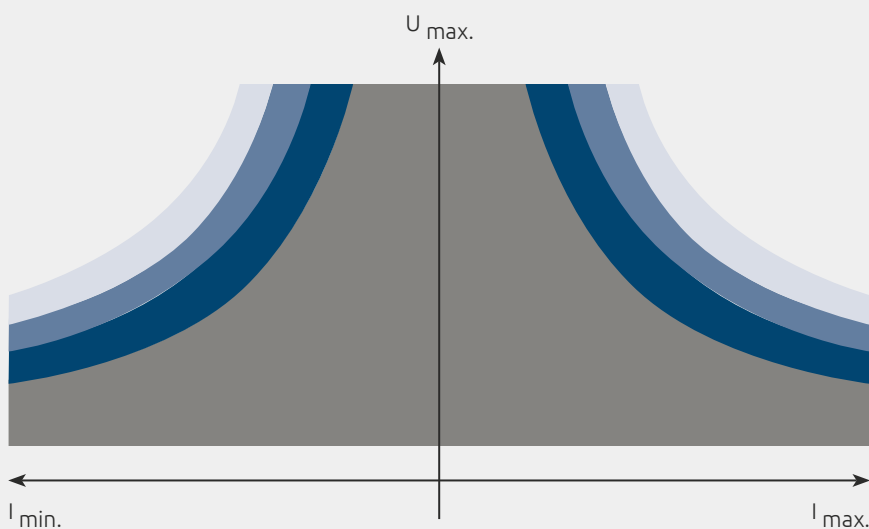

Standard features

The I-TS-3870 impresses even in the standard system configuration with its extensive equipment and is therefore ready for immediate use by customers from all over the world. The following is a small excerpt:

General information

- Input voltage 380 / 400 V, 50 / 60 Hz
- Sense connections for voltage measurement / regulation
- DC current and voltage measurement with 0.1 % full scale accuracy
- Battery tester version
- Protection class IP20
- Noise-reduced design (vibration metals, fan control)
- Air cooling

Safety features

- Lockable main switch as load-break switch with fuses
- Safety control for Performance Level d in accordance with EN 60204-1 / ISO 13849-1.
- Stop switch in cabinet door
- Voltmeter and indicator light in cabinet door
- Redundant DC output contactors
- Connection terminals for external „emergency stop“
- Connection terminals for external „stop“
- DC output electrically isolated from the AC mains (galvanic isolation)

Interfaces

- 10 inch display with touch operation
- Modbus / TCP interface
- CAN interface (100 Hz, dbc file available)
- VNC interface



Options (extract)

- **Security level**
Increase to performance level e as a special option
- **Battery emulation version (increased output capacity)**
Hardware and software adaptation for special applications to improve voltage stability for battery emulation
- **Protective diode at the DC output**
Switchable diode to protect the device under test in sink-only mode
- **Insulation monitoring**
Protective device for monitoring the galvanic isolation of the DC output
- **Parallel operation**
Increase in available power for certain applications through master-slave operation
- **Interfaces**
Large selection of various optional interfaces such as CAN high-speed (1 kHz), SCPI, EtherCAT, Profibus, Profinet, analog, LabVIEW, Matlab/Simulink
- **DC output contactors with higher performance**
DC output contactors with increased current capability are optionally available to increase the service life
- **Door contact switch, door locking device, special locking cylinder**
Operator safety is our top priority, therefore additional safety equipment is available for our customers
- **System cabinets in a special design**
Rittal enclosures, special bases, enclosures on castors, special paint finishes, wire end marking. The I-TS can be adapted to a wide range of customer requirements and local conditions
- **NA protection with grid analysis measuring device for power generation systems (VDE-AR-N 4105, VDE-AR-N 4110)**
Due to grid operator regulations, NA protection may be required to monitor the grid quality for the I-TS
- **Water cooling including increased protection class IP54**
Water cooling of the system cabinets is available to minimize waste heat to the room or to reduce noise. This also increases the protection class of the I-TS

General technical data I-TS-3870

AC mains voltage / AC mains frequency	380 / 400 / 440 / 480 / 690 V ± 10 %, 3-phase, PE, 50 / 60 Hz ± 5 %
Measurement accuracy	Voltage: 16 Bit ADC // Current: 16 Bit ADC
Control accuracy	Voltage: 0,1 % fs // Current: 0,1 % fs
Ripple voltage / current	≤ 0,1 % eff. fs
Voltage tolerance dynamic (0-100 % INom in 3 ms)	Battery tester < 3 % fs Battery emulator < 1 % fs
Short circuit performance	Short circuit proof: Systems up to 600 A: I _{cw} : 3 kA Systems with 1000 A: I _{cw} : 8 kA Systems with 1200 A: I _{cw} : 15 kA
Permissible environmental conditions: Storage as per EN 60721-3-1 Transport as per EN 60721-3-2 Operation as per EN 60721-3-3	1K21 / 1M11, +5 to +40 °C 2K12 / 2M4, -45 to +70 °C 3K22 / 3M11, +5 to +40 °C
Cooling method	Enforced air cooling (IP20, IP21, IP23) // enforced water cooling (IP54)
Safety of machinery - Safety-related parts of control systems	EN ISO 13849-1 EN ISO 13849-2
Safety of machinery	EN 60204-1 Exception: • Sec. 11.3 Protection type see Techn. Data • Sec. 13.2 Identification of conductors
EMC Standards	EN 61000-2-4 Class 3 EN 61000-6-2 EN 61000-6-4 respectively EN 55011 (Tab. 2) EN 61800-3 Cat.C2 (A1)

Type

Power in kW

Current in A

Dimensions (W x D x H in mm)

Voltage range 5 – 80 V

I-TS-3870-80-35-1000	35	1000	1000 x 800 x 1800
----------------------	----	------	-------------------

Voltage range 5 – 120 V

I-TS-3870-120-50-1000	50	1000	1000 x 800 x 1800
-----------------------	----	------	-------------------

Voltage range 5 – 300 V

I-TS-3870-300-60-200	60	200	1400 x 800 x 2000
I-TS-3870-300-60-600	60	600	1400 x 800 x 2000
I-TS-3870-300-60-1000	60	1000	(1000 + 1200) x 800 x 2000
I-TS-3870-300-120-600	120	600	(1200 + 1000) x 800 x 2000
I-TS-3870-300-120-1000	120	1000	(1200 + 1200) x 800 x 2000
I-TS-3870-300-160-600	160	600	(1400 + 1000) x 800 x 2000
I-TS-3870-300-160-1000	160	1000	(1400 + 1200) x 800 x 2000

Voltage range 5 – 600 V

I-TS-3870-600-60-200	60	200	1400 x 800 x 2000
I-TS-3870-600-60-600	60	600	1400 x 1000 x 2000
I-TS-3870-600-60-1000	60	1000	(1000 + 1200) x 800 x 2000
I-TS-3870-600-100-200	100	200	(1000 + 1000) x 800 x 2000
I-TS-3870-600-100-600	100	600	(1000 + 1000) x 800 x 2000
I-TS-3870-600-100-1000	100	1000	(1000 + 1200) x 800 x 2000
I-TS-3870-600-160-600	160	600	(1200 + 1000) x 800 x 2000
★ I-TS-3870-600-160-1000	160	1000	(1200 + 1200) x 800 x 2000
I-TS-3870-600-250-600	250	600	(1400 + 1000) x 800 x 2000
I-TS-3870-600-250-1000	250	1000	(1400 + 1200) x 800 x 2000
I-TS-3870-600-320-600	320	600	(1400 + 1000) x 800 x 2000
I-TS-3870-600-320-1000	320	1000	(1400 + 1200) x 800 x 2000
I-TS-3870-600-400-1000	400	1000	(1200 + 1200 + 1200) x 800 x 2000
I-TS-3870-600-500-1000	500	1000	(1400 + 1200 + 1200) x 800 x 2000

Type	Power in kW	Current in A	Dimensions (W x D x H in mm)
------	-------------	--------------	------------------------------

Voltage range 5 – 800 V

I-TS-3870-800-100-200	100	200	(1000 + 1000) x 800 x 2000
I-TS-3870-800-100-600	100	600	(1000 + 1000) x 800 x 2000
I-TS-3870-800-100-1000	100	1000	(1000 + 1200) x 800 x 2000
I-TS-3870-800-160-200	160	200	(1200 + 1000) x 800 x 2000
I-TS-3870-800-160-600	160	600	(1200 + 1000) x 800 x 2000
I-TS-3870-800-160-1000	160	1000	(1200 + 1200) x 800 x 2000
I-TS-3870-800-250-600	250	600	(1400 + 1000) x 800 x 2000
I-TS-3870-800-250-1000	250	1000	(1400 + 1200) x 800 x 2000
I-TS-3870-800-320-600	320	600	(1400 + 1000) x 800 x 2000
I-TS-3870-800-320-1000	320	1000	(1400 + 1200) x 800 x 2000
I-TS-3870-800-400-1000	400	1000	(1200 + 1200 + 1200) x 800 x 2000
I-TS-3870-800-500-1000	500	1000	(1400 + 1200 + 1200) x 800 x 2000

Voltage range 5 – 1000 V

I-TS-3870-1000-60-200	60	200	1400 x 1000 x 2000
I-TS-3870-1000-100-200	100	200	(1000 + 1000) x 800 x 2000
I-TS-3870-1000-100-600	100	600	(1000 + 1200) x 800 x 2000
I-TS-3870-1000-100-1000	100	1000	(1000 + 1200) x 800 x 2000
I-TS-3870-1000-100-1200	100	1200	(1000 + 1200) x 800 x 2000
I-TS-3870-1000-160-200	160	200	(1200 + 1000) x 800 x 2000
I-TS-3870-1000-160-600	160	600	(1200 + 1200) x 800 x 2000
I-TS-3870-1000-160-1000	160	1000	(1200 + 1200) x 800 x 2000
I-TS-3870-1000-160-1200	160	1200	(1200 + 1200) x 800 x 2000
I-TS-3870-1000-250-600	250	600	(1400 + 1200) x 800 x 2000
★ I-TS-3870-1000-250-1000	250	1000	(1400 + 1200) x 800 x 2000
I-TS-3870-1000-250-1200	250	1200	(1400 + 1200) x 800 x 2000
I-TS-3870-1000-320-600	320	600	(1400 + 1200) x 800 x 2000
I-TS-3870-1000-320-1000	320	1000	(1400 + 1200) x 800 x 2000
I-TS-3870-1000-320-1200	320	1200	(1400 + 1200) x 800 x 2000
I-TS-3870-1000-400-600	400	600	(1200 + 1200 + 1200) x 800 x 2000
I-TS-3870-1000-400-1000	400	1000	(1200 + 1200 + 1200) x 800 x 2000
I-TS-3870-1000-400-1200	400	1200	(1200 + 1200 + 1200) x 800 x 2000
I-TS-3870-1000-500-600	500	600	(1400 + 1200 + 1200) x 800 x 2000
I-TS-3870-1000-500-1000	500	1000	(1400 + 1200 + 1200) x 800 x 2000
I-TS-3870-1000-500-1200	500	1200	(1400 + 1200 + 1200) x 800 x 2000
★ I-TS-3870-1000-650-1000	650	1000	(1600 + 1200 + 1200) x 800 x 2200
I-TS-3870-1000-650-1200	650	1200	(1600 + 1200 + 1200) x 800 x 2200

Voltage range 10 - 1200 V

I-TS-3870-1200-320-600	320	600	(1400 + 1200) x 800 x 2000
★ I-TS-3870-1200-320-1200	320	1200	(1400 + 1200) x 800 x 2000
★ I-TS-3870-1200-650-1200	650	1200	(1600 + 1200 + 1200) x 800 x 2200

Voltage range 10 - 1500 V

I-TS-3870-1500-400-800	400	800	(1200 + 1200 + 1200) x 800 x 2200
------------------------	-----	-----	-----------------------------------

★ These types are particularly popular by our customers.

Single-Channel System – overload

I-TS-3870-ol

Our high-performance test system I-TS-overload (Infeed test system – overload) is a high dynamic, bidirectional DC power supply with continuous and seamless transition from source to sink operation. The outstanding performance is the basis for a wide range of applications in the automotive, hydrogen and laboratory sectors.

The I-TS-3870 overload version of our Infeed test system enables a short-term overload at the DC output. This means that certain operating points outside the nominal range can be approached and thus requirements in the test sequence can be fulfilled by the I-TS.

The technical data of the DC converter in terms of output voltage and output current remain unchanged. However, up to 50 % higher rated output load is available for a maximum of 60 s. The subsequent regeneration time (\leq nominal load) is 5 times the overload time.

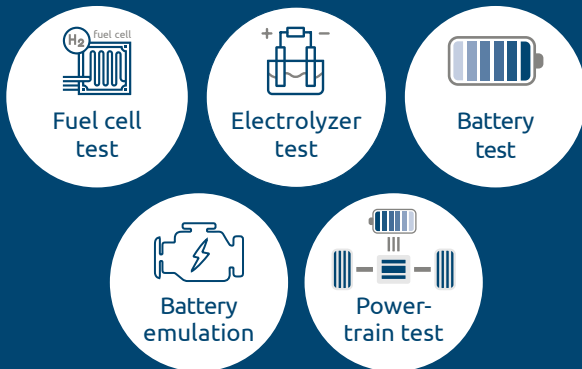

Circuit diagram

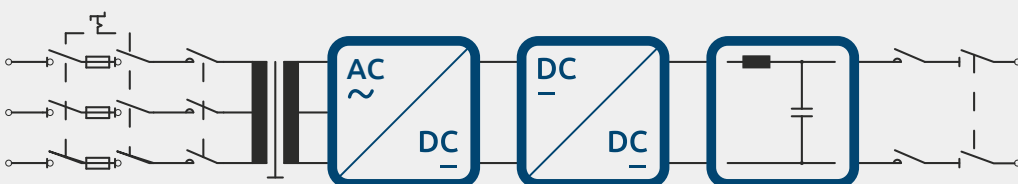

Standard features

The I-TS-3870-ol (overload) impresses even in the standard system configuration with its extensive equipment and is therefore ready for immediate use by customers from all over the world. The following is a small excerpt:

General information

- Input voltage 380 / 400 V, 50 / 60 Hz
- Sense connections for voltage measurement / regulation
- DC current and voltage measurement with 0.1 % full scale accuracy
- Battery tester version
- Protection class IP20
- Noise-reduced design (vibration metals, fan control)
- Air cooling

Safety features

- Lockable main switch as load-break switch with fuses
- Safety control for Performance Level d in accordance with EN 60204-1 / ISO 13849-1.
- Stop switch in cabinet door
- Voltmeter and indicator light in cabinet door
- Redundant DC output contactors
- Connection terminals for external „emergency stop“
- Connection terminals for external „stop“
- DC output electrically isolated from the AC mains (galvanic isolation)

Interfaces

- 10 inch display with touch operation
- Modbus / TCP interface
- CAN interface (100 Hz, dbc file available)
- VNC interface via Ethernet



Options (extract)

- **Security level**
Increase to performance level e as a special option
- **Battery emulation version (increased output capacity)**
Hardware and software adaptation for special applications to improve voltage stability for battery emulation
- **Protective diode at the DC output**
Switchable diode to protect the device under test in sink-only mode
- **Insulation monitoring**
Protective device for monitoring the galvanic isolation of the DC output
- **Parallel operation**
Increase in available power for certain applications through master-slave operation
- **Interfaces**
Large selection of various optional interfaces such as CAN high-speed (1 kHz), SCPI, EtherCAT, Profibus, Profinet, analog, LabVIEW, Matlab/Simulink
- **DC output contactors with higher performance**
DC output contactors with increased current capability are optionally available to increase the service life
- **Door contact switch, door locking device, special locking cylinder**
Operator safety is our top priority, therefore additional safety equipment is available for our customers
- **System cabinets in a special design**
Rittal enclosures, special bases, enclosures on castors, special paint finishes, wire end marking. The I-TS can be adapted to a wide range of customer requirements and local conditions
- **NA protection with grid analysis measuring device for power generation systems (VDE-AR-N 4105, VDE-AR-N 4110)**
Due to grid operator regulations, NA protection may be required to monitor the grid quality for the I-TS
- **Water cooling including increased protection class IP54**
Water cooling of the system cabinets is available to minimize waste heat to the room or to reduce noise. This also increases the protection class of the I-TS

Performance hyperbole

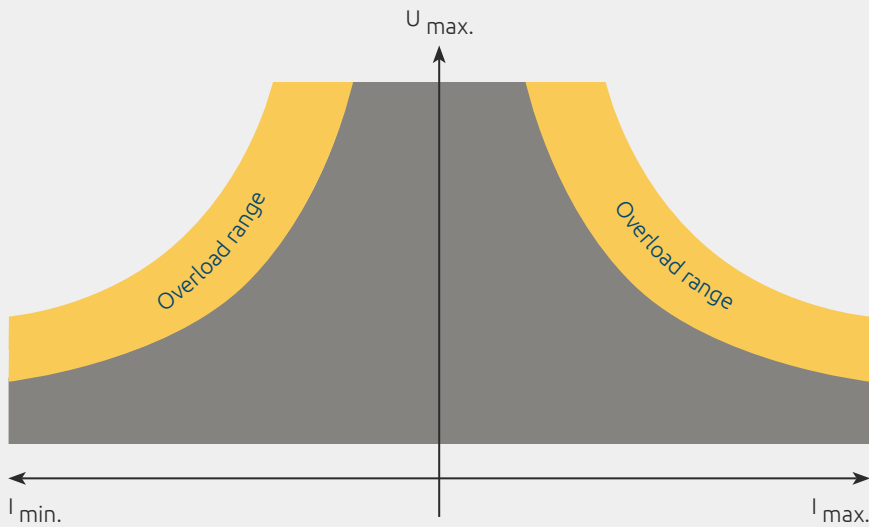

General technical data I-TS-3870-ol

AC mains voltage / AC mains frequency	380 / 400 / 440 / 480 / 690 V ± 10 %, 3-phase, PE, 50 / 60 Hz ± 5 %
Measurement accuracy	Voltage: 16 Bit ADC // Current: 16 Bit ADC
Control accuracy	Voltage: 0,1 % fs // Current: 0,1 % fs
Ripple voltage / current	≤ 0,1 % eff. fs
Voltage tolerance dynamic (0-100 % INom in 3 ms)	Battery tester < 3 % fs Battery emulator < 1 % fs
Short circuit performance	Short circuit proof: Systems up to 600 A: I _{cw} : 3 kA Systems with 1000 A: I _{cw} : 8 kA Systems with 1200 A: I _{cw} : 15 kA
Permissible environmental conditions: Storage as per EN 60721-3-1 Transport as per EN 60721-3-2 Operation as per EN 60721-3-3	1K21 / 1M11, +5 to +40 °C 2K12 / 2M4, -45 to +70 °C 3K22 / 3M11, +5 to +40 °C
Cooling method	Enforced air cooling (IP20, IP21, IP23) // enforced water cooling (IP54)
Safety of machinery - Safety-related parts of control systems	EN ISO 13849-1 EN ISO 13849-2
Safety of machinery	EN 60204-1 Exception: • Sec. 11.3 Protection type see Techn. Data • Sec. 13.2 Identification of conductors
EMC standards	EN 61000-2-4 Class 3 EN 61000-6-2 EN 61000-6-4 respectively EN 55011 (Tab. 2) EN 61800-3 Cat.C2 (A1)

Type	Power in kW	Current in A	Overload in % for 60 s then 3 min cooling time at nominal load	Dimensions (W x D x H in mm)
------	-------------	--------------	--	------------------------------

Voltage range 5 – 600 V

I-TS-3870-600-60-200-ol	60	200	50%	(1000 + 1000) x 800 x 2000
I-TS-3870-600-60-600-ol	60	600	50%	(1000 + 1000) x 800 x 2000
I-TS-3870-600-60-1000-ol	60	1000	50%	(1000 + 1200) x 800 x 2000
I-TS-3870-600-100-600-ol	100	600	50%	(1200 + 1000) x 800 x 2000
I-TS-3870-600-100-1000-ol	100	1000	50%	(1200 + 1200) x 800 x 2000
I-TS-3870-600-160-600-ol	160	600	50%	(1400 + 1000) x 800 x 2000
I-TS-3870-600-160-1000-ol	160	1000	50%	(1400 + 1200) x 800 x 2000
I-TS-3870-600-250-600-ol	250	600	25%	(1400 + 1000) x 800 x 2000
I-TS-3870-600-250-1000-ol	250	1000	25%	(1400 + 1200) x 800 x 2000
I-TS-3870-600-320-1000-ol	320	1000	25%	(1200 + 1200 + 1200) x 800 x 2000
I-TS-3870-600-400-1000-ol	400	1000	25%	(1400 + 1200 + 1200) x 800 x 2000

Voltage range 5 - 800 V

I-TS-3870-800-100-200-ol	100	200	50%	(1200 + 1000) x 800 x 2000
I-TS-3870-800-100-600-ol	100	600	50%	(1200 + 1000) x 800 x 2000
I-TS-3870-800-100-1000-ol	100	1000	50%	(1200 + 1200) x 800 x 2000
I-TS-3870-800-160-600-ol	160	600	50%	(1400 + 1000) x 800 x 2000
I-TS-3870-800-160-1000-ol	160	1000	50%	(1400 + 1200) x 800 x 2000
★ I-TS-3870-800-250-600-ol	250	600	25%	(1400 + 1000) x 800 x 2000
I-TS-3870-800-250-1000-ol	250	1000	25%	(1400 + 1200) x 800 x 2000
I-TS-3870-800-320-600-ol	320	600	25%	(1200 + 1200 + 1000) x 800 x 2000
I-TS-3870-800-320-1000-ol	320	1000	25%	(1200 + 1200 + 1200) x 800 x 2000
I-TS-3870-800-400-1000-ol	400	1000	25%	(1400 + 1200 + 1200) x 800 x 2000
I-TS-3870-600-400-1000-ol	400	1000	25%	(1400 + 1200 + 1200) x 800 x 2000

Voltage range 5 - 1000 V

I-TS-3870-1000-60-200-ol	60	200	50%	(1000 + 1000) x 800 x 2000
I-TS-3870-1000-100-200-ol	100	200	50%	(1200 + 1000) x 800 x 2000
I-TS-3870-1000-100-600-ol	100	600	50%	(1200 + 1200) x 800 x 2000
I-TS-3870-1000-100-1000-ol	100	1000	50%	(1200 + 1200) x 800 x 2000
I-TS-3870-1000-100-1200-ol	100	1200	50%	(1200 + 1200) x 800 x 2000
I-TS-3870-1000-160-600-ol	160	600	50%	(1400 + 1200) x 800 x 2000
I-TS-3870-1000-160-1000-ol	160	1000	50%	(1400 + 1200) x 800 x 2000
I-TS-3870-1000-160-1200-ol	160	1200	50%	(1400 + 1200) x 800 x 2000
I-TS-3870-1000-250-600-ol	250	600	25%	(1400 + 1200) x 800 x 2000
I-TS-3870-1000-250-1000-ol	250	1000	25%	(1400 + 1200) x 800 x 2000
I-TS-3870-1000-250-1200-ol	250	1200	25%	(1400 + 1200) x 800 x 2000
I-TS-3870-1000-320-600-ol	320	600	25%	(1200 + 1200 + 1200) x 800 x 2000
★ I-TS-3870-1000-320-1000-ol	320	1000	25%	(1200 + 1200 + 1200) x 800 x 2000
I-TS-3870-1000-320-1200-ol	320	1200	25%	(1200 + 1200 + 1200) x 800 x 2000
I-TS-3870-1000-400-600-ol	400	600	25%	(1400 + 1200 + 1200) x 800 x 2000
I-TS-3870-1000-400-1000-ol	400	1000	25%	(1400 + 1200 + 1200) x 800 x 2000
I-TS-3870-1000-400-1200-ol	400	1200	25%	(1400 + 1200 + 1200) x 800 x 2000
★ I-TS-3870-1000-500-1000-ol	500	1000	25%	(1600 + 1200 + 1200) x 800 x 2200
★ I-TS-3870-1000-500-1200-ol	500	1200	25%	(1600 + 1200 + 1200) x 800 x 2200

★ These types are particularly popular by our customers.

Multi-Channel System

MI-TS-3871

Our high-performance test system MI-TS (Multichannel Infeed test system) is a multi-channel, highly dynamic, bidirectional DC power supply with continuous and seamless transition from source to sink mode. Thanks to its multi-channel capability and outstanding performance, the MI-TS is the ideal test system for a wide range of applications in the automotive, hydrogen and laboratory sectors. At the same time, it offers the possibility of increasing performance thanks to parallel output channels.



Circuit diagram

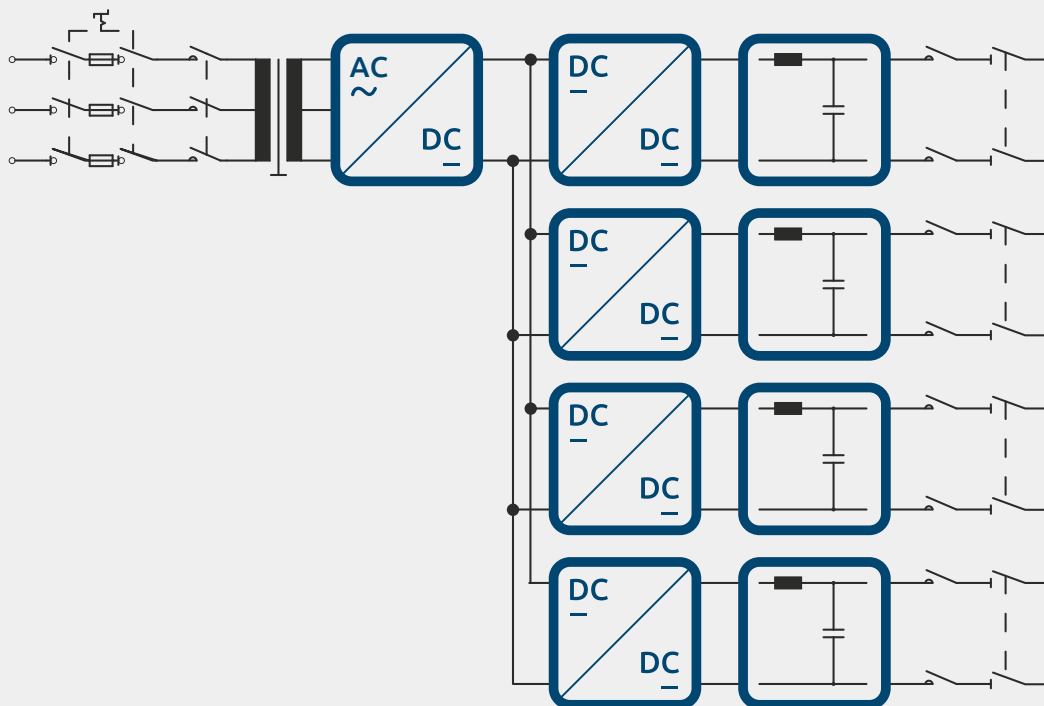

Standard features

The MI-TS-3871 impresses even in the standard system configuration with its extensive equipment and is therefore ready for immediate use by customers from all over the world. The following is a small excerpt:

General information

- Input voltage 380 / 400 V, 50 / 60 Hz
- Sense connections for voltage measurement / regulation
- DC current and voltage measurement with 0.1 % full scale accuracy
- Battery tester version
- Protection class IP20
- Noise-reduced design (vibration metals, fan control)
- Air cooling
- Parallel operation of the output channels to increase the current

Safety features

- Lockable main switch as load-break switch with fuses
- Safety control for Performance Level d in accordance with EN 60204-1 / ISO 13849-1.
- Stop switch in cabinet door
- Voltmeter and indicator light in cabinet door
- Redundant DC output contactors
- Connection terminals for external „emergency stop“
- Connection terminals for external „stop“
- DC output electrically isolated from the AC mains (galvanic isolation)

Interfaces

- 10 inch display with touch operation
- Modbus / TCP interface
- CAN interface (100 Hz, dbc file available)
- VNC interface via Ethernet

Options (extract)

- **Security level**
Increase to performance level e as a special option
- **Battery emulation version (increased output capacity)**
Hardware and software adaptation for special applications to improve voltage stability for battery emulation
- **Protective diode at the DC output**
Switchable diode to protect the device under test in sink-only mode
- **Insulation monitoring**
Protective device for monitoring the galvanic isolation of the DC output
- **Interfaces**
Large selection of various optional interfaces such as CAN high-speed (1 kHz), SCPI, EtherCAT, Profibus, Profinet, analog, LabVIEW, Matlab/Simulink
- **DC output contactors with higher performance**
DC output contactors with increased current capability are optionally available to increase the service life
- **Door contact switch, door locking device, special locking cylinder**
Operator safety is our top priority, therefore additional safety equipment is available for our customers
- **System cabinets in a special design**
Rittal enclosures, special bases, enclosures on castors, special paint finishes, wire end marking. The MI-TS can be adapted to a wide range of customer requirements and local conditions
- **NA protection with grid analysis measuring device for power generation systems (VDE-AR-N 4105, VDE-AR-N 4110)**
Due to grid operator regulations, NA protection may be required to monitor the grid quality for the MI-TS
- **Water cooling including increased protection class IP54**
Water cooling of the system cabinets is available to minimize waste heat to the room or to reduce noise. This also increases the protection class of the MI-TS



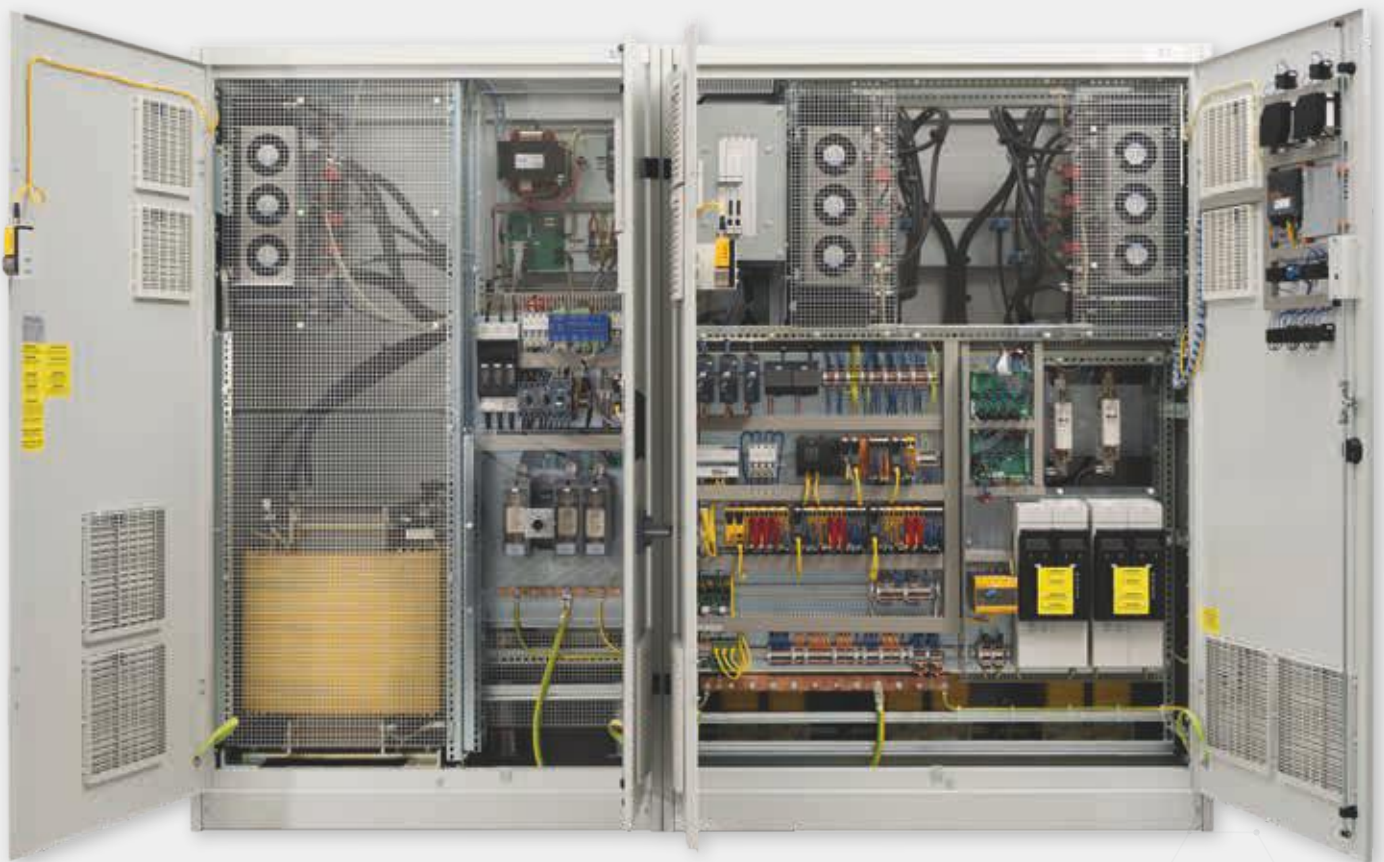

General technical data MI-TS-3871

AC mains voltage / AC mains frequency	380 / 400 / 440 / 480 / 690 V ± 10 %, 3-phase, PE, 50 / 60 Hz ± 5 %
Measurement accuracy	Voltage: 16 Bit ADC // Current: 16 Bit ADC
Control accuracy	Voltage: 0,1 % fs // Current: 0,1 % fs
Ripple voltage / current	≤ 0,1 % eff. fs
Voltage tolerance dynamic (0-100 % INom in 3 ms)	Battery tester < 3 % fs Battery emulator < 1 % fs
Short circuit performance	Short circuit proof: Systems up to 600 A: I _{cw} : 3 kA Systems with 1000 A: I _{cw} : 8 kA Systems with 1200 A: I _{cw} : 15 kA
Permissible environmental conditions: Storage as per EN 60721-3-1 Transport as per EN 60721-3-2 Operation as per EN 60721-3-3	1K21 / 1M11, +5 to +40 °C 2K12 / 2M4, -45 to +70 °C 3K22 / 3M11, +5 to +40 °C
Cooling method	Enforced air cooling (IP20, IP21, IP23) // enforced water cooling (IP54)
Safety of machinery - Safety-related parts of control systems	EN ISO 13849-1 EN ISO 13849-2
Safety of machinery	EN 60204-1 Exception: • Sec. 11.3 Protection type see Techn. Data • Sec. 13.2 Identification of conductors
EMC standards	EN 61000-2-4 Class 3 EN 61000-6-2 EN 61000-6-4 respectively EN 55011 (Tab. 2) EN 61800-3 Cat.C2 (A1)

Type Channels Power in kW Current in A Dimensions (W x D x H in mm)

Voltage range 5 – 300 V

MI-TS-3871-300-60-600-2	2	60	600	(1000 + 1400) x 800 x 2000
-------------------------	---	----	-----	----------------------------

Voltage range 5 – 600 V

MI-TS-3871-600-160-600-2	2	160	600	(1200 + 1400) x 800 x 2000
★ MI-TS-3871-600-320-1000-4	4	320	1000	(1400 + 1200 + 1200 + 1200 + 1200) x 800 x 2000

Voltage range 5 – 800 V

MI-TS-3871-800-160-600-2	2	160	600	(1200 + 1400) x 800 x 2000
MI-TS-3871-800-320-600-4	4	320	600	(1400 + 1400 + 1400) x 800 x 2000
★ MI-TS-3871-800-500-600-4	4	500	600	(1400 + 1200 + 1400 + 1400) x 800 x 2000

Voltage range 5 – 1000 V

★ MI-TS-3871-1000-250-1000-2	2	250	1000	(1400 + 1200 + 1200) x 800 x 2000
★ MI-TS-3871-1000-320-1200-2	2	320	1200	(1400 + 1200 + 1200) x 800 x 2000
MI-TS-3871-1000-400-600-4	4	400	600	(1200 + 1200 + 1200 + 1200 + 1200 + 1200) x 800 x 2000
MI-TS-3871-1000-400-1000-2	2	400	1000	(1200 + 1200 + 1200 + 1200) x 800 x 2000
MI-TS-3871-1000-500-1000-2	2	500	1000	(1400 + 1200 + 1200 + 1200) x 800 x 2000
★ MI-TS-3871-1000-650-1000-4	4	650	1000	(1600 + 1200 + 1200 + 1200 + 1200 + 1200) x 800 x 2200

Voltage range 10 – 1200 V

★ MI-TS-3871-1200-320-1200-2	2	320	1200	(1400 + 1200 + 1200) x 800 x 2000
MI-TS-3871-1200-320-600-4	4	320	600	(1400 + 1200 + 1200 + 1200 + 1200) x 800 x 2000
★ MI-TS-3871-1200-650-1200-2	2	650	1200	(1600 + 1200 + 1200 + 1200) x 800 x 2200

Voltage range 10 – 1500 V

MI-TS-3871-1500-400-800-2	2	400	800	(1200 + 1200 + 1200 + 1200) x 800 x 2200
---------------------------	---	-----	-----	--

★ These types are particularly popular by our customers.

Excerpt from the product range, over 400 types available.

Multi-Channel System – overload

MI-TS-3871-ol

Our high-performance test system MI-TS (Multichannel Infeed test system – overload) is a multi-channel, highly dynamic, bidirectional DC power supply with continuous and seamless transition from source to sink mode. Thanks to its multi-channel capability and outstanding performance, the MI-TS is the ideal test system for a wide range of applications in the automotive, hydrogen and laboratory sectors.

The MI-TS-3871-overload version of our multichannel Infeed test system enables a short-term overload at the DC output and also offers the option of parallel output channels. This means that certain operating points outside the nominal range can be approached and thus requirements in the test sequence can be fulfilled by the MI-TS.

The technical data of the DC converter in terms of output voltage and output current remain unchanged. However, a nominal output load up to 50 % higher is available for a maximum of 60 s. The subsequent regeneration time (\leq nominal load) is 5 times the overload time.

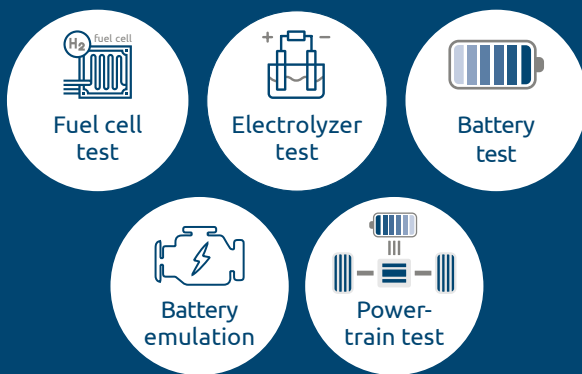

Standard features

The M-TS-3871-ol (overload) impresses even in the standard system configuration with its extensive equipment and is therefore ready for immediate use by customers from all over the world. The following is a small excerpt:

General information

- Input voltage 380 / 400 V, 50 / 60 Hz
- Sense connections for voltage measurement / regulation
- DC current and voltage measurement with 0.1 % full scale accuracy
- Battery tester version
- Protection class IP20
- Noise-reduced design (vibration metals, fan control)
- Air cooling
- Parallel operation of the output channels to increase the current

Safety features

- Lockable main switch as load-break switch with fuses
- Safety control for Performance Level d in accordance with EN 60204-1 / ISO 13849-1.
- Stop switch in cabinet door
- Voltmeter and indicator light in cabinet door
- Redundant DC output contactors
- Connection terminals for external „emergency stop“
- Connection terminals for external „stop“
- DC output electrically isolated from the AC mains (galvanic isolation)

Interfaces

- 10 inch display with touch operation
- Modbus / TCP interface
- CAN interface (100 Hz, dbc file available)
- VNC interface via Ethernet

Options (extract)

- **Security level**
Increase to performance level e as a special option
- **Battery emulation version (increased output capacity)**
Hardware and software adaptation for special applications to improve voltage stability for battery emulation
- **Protective diode at the DC output**
Switchable diode to protect the device under test in sink-only mode
- **Insulation monitoring**
Protective device for monitoring the galvanic isolation of the DC output
- **Interfaces**
Large selection of various optional interfaces such as CAN high-speed (1 kHz), SCPI, EtherCAT, Profibus, Profinet, analog, LabVIEW, Matlab/Simulink
- **DC output contactors with higher performance**
DC output contactors with increased current capability are optionally available to increase the service life
- **Door contact switch, door locking device, special locking cylinder**
Operator safety is our top priority, therefore additional safety equipment is available for our customers
- **System cabinets in a special design**
Rittal enclosures, special bases, enclosures on castors, special paint finishes, wire end marking. The MI-TS can be adapted to a wide range of customer requirements and local conditions
- **NA protection with grid analysis measuring device for power generation systems (VDE-AR-N 4105, VDE-AR-N 4110)**
Due to grid operator regulations, NA protection may be required to monitor the grid quality for the MI-TS
- **Water cooling including increased protection class IP54**
Water cooling of the system cabinets is available to minimize waste heat to the room or to reduce noise. This also increases the protection class of the MI-TS



Circuit diagram

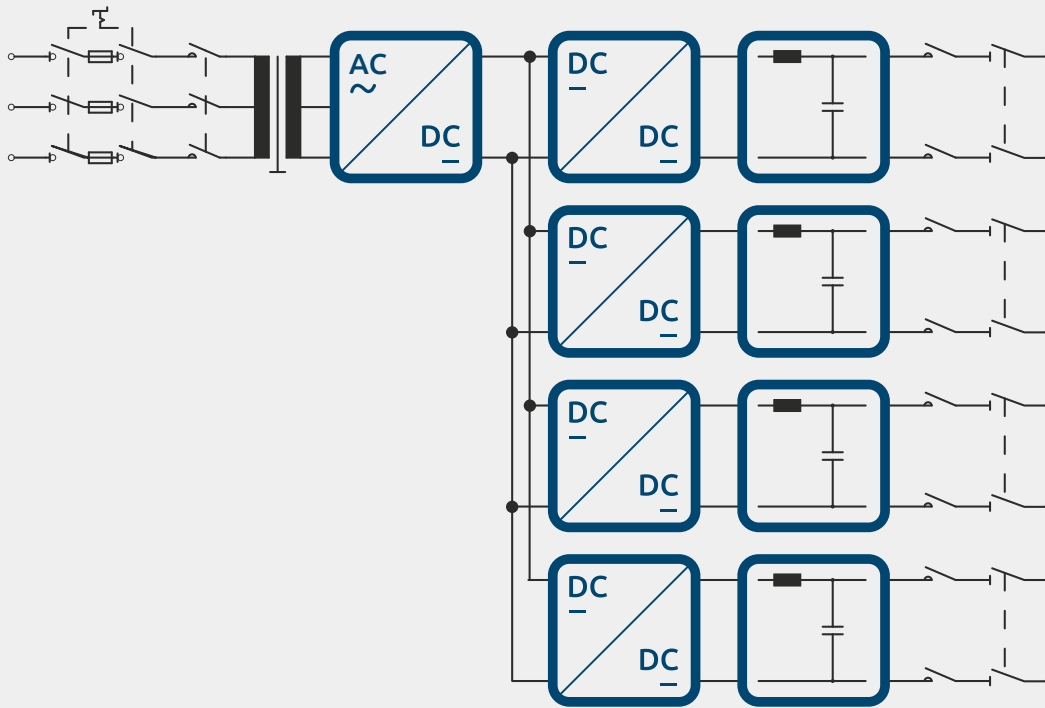

General technical data MI-TS-3871-ol

AC mains voltage / AC mains frequency	380 / 400 / 440 / 480 / 690 V ± 10 %, 3-phase, PE, 50 / 60 Hz ± 5 %
Measurement accuracy	Voltage: 16 Bit ADC // Current: 16 Bit ADC
Control accuracy	Voltage: 0,1 % fs // Current: 0,1 % fs
Ripple voltage / current	≤ 0,1 % eff. fs
Voltage tolerance dynamic (0-100 % INom in 3 ms)	Battery tester < 3 % fs Battery emulator < 1 % fs
Short circuit performance	Short circuit proof: Systems up to 600 A: I _{cw} : 3 kA Systems with 1000 A: I _{cw} : 8 kA Systems with 1200 A: I _{cw} : 15 kA
Permissible environmental conditions: Storage as per EN 60721-3-1 Transport as per EN 60721-3-2 Operation as per EN 60721-3-3	1K21 / 1M11, +5 to +40 °C 2K12 / 2M4, -45 to +70 °C 3K22 / 3M11, +5 to +40 °C
Cooling method	Enforced air cooling (IP20, IP21, IP23) // enforced water cooling (IP54)
Safety of machinery - Safety-related parts of control systems	EN ISO 13849-1 EN ISO 13849-2
Safety of machinery	EN 60204-1 Exception: • Sec. 11.3 Protection type see Techn. Data • Sec. 13.2 Identification of conductors
EMC standards	EN 61000-2-4 Class 3 EN 61000-6-2 EN 61000-6-4 respectively EN 55011 (Tab. 2) EN 61800-3 Cat.C2 (A1)

Type	Channels	Power in kW	Current in A	Dimensions (W x D x H in mm)
Voltage range 5 – 600 V				
MI-TS-3871-600-160-600-2-ol	2	160	600	(1400 + 1400) x 800 x 2000
★ MI-TS-3871-600-320-1000-4-ol	4	320	1000	(1200 + 1200 + 1200 + 1200 + 1200 + 1200) x 800 x 2000
Voltage range 5 – 800 V				
MI-TS-3871-800-160-600-2-ol	2	160	600	(1400 + 1400) x 800 x 2000
★ MI-TS-3871-800-320-600-4-ol	4	320	600	(1200 + 1200 + 1400 + 1400) x 800 x 2000
Voltage range 5 – 1000 V				
MI-TS-3871-1000-250-1000-2-ol	2	250	1000	(1400 + 1200 + 1200) x 800 x 2000
MI-TS-3871-1000-320-1200-2-ol	2	320	1200	(1200 + 1200 + 1200 + 1200) x 800 x 2000
MI-TS-3871-1000-400-600-4-ol	4	400	600	(1400 + 1200 + 1200 + 1200 + 1200 + 1200) x 800 x 2000
★ MI-TS-3871-1000-400-1000-2-ol	2	400	1000	(1400 + 1200 + 1200 + 1200) x 800 x 2000
MI-TS-3871-1000-500-1000-2-ol	2	500	1000	(1600 + 1200 + 1200 + 1200) x 800 x 2200

★ These types are particularly popular by our customers.

Excerpt from the product range, over 100 types available.

Flex-Channel System

I-TS-3872

Our high-performance test system I-TS (Infeed test system) is a high dynamic, bidirectional DC power supply with continuous and seamless transition from source to sink operation. Thanks to the 3-level technology, it offers an adjustable voltage range of 10 – 1500 V with a center point. The DC channels can also be operated individually or in parallel. The outstanding performance is the basis for a wide range of applications in the automotive, hydrogen and laboratory sectors.

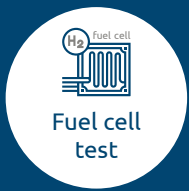

Performance hyperbole

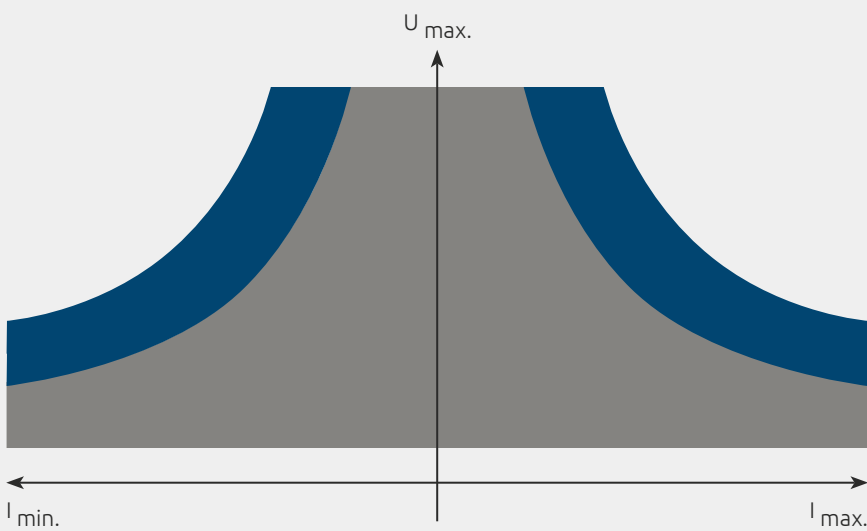

Circuit diagram

Single Mode: DCC1, DCC2

DCC1 and DCC2 are operated separately.
The DC converters are controlled individually.

Performance values (nominal data):
UDC = 2x 5 – 750 V
IDC = 2x -1000 A to 1000 A

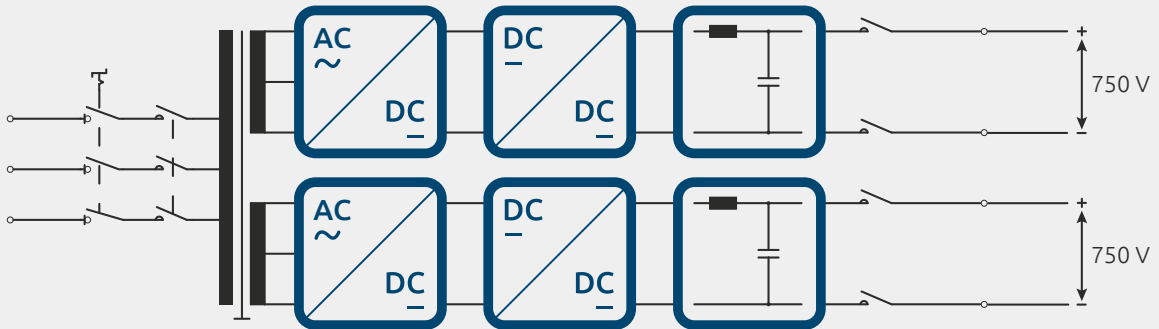

Seriell Mode: DCC1 – DCC2

DCC1 and DCC2 are connected in serie.

Performance values (nominal data):
UDC = 10 – 1500 V
IDC = -1000 A to 1000 A

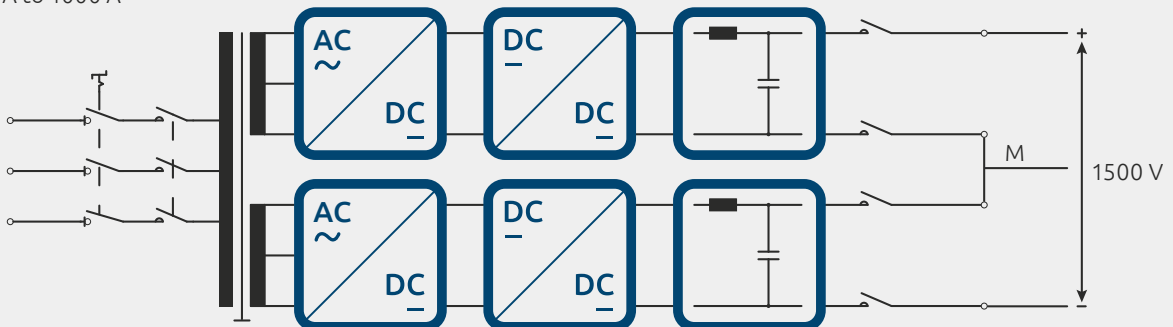

Parallel Mode: DCC1 II DCC2

DCC1 and DCC2 are connected in parallel

Goal power values (nominal data):
UDC = 5 – 750 V
IDC = -2000 A to 2000 A

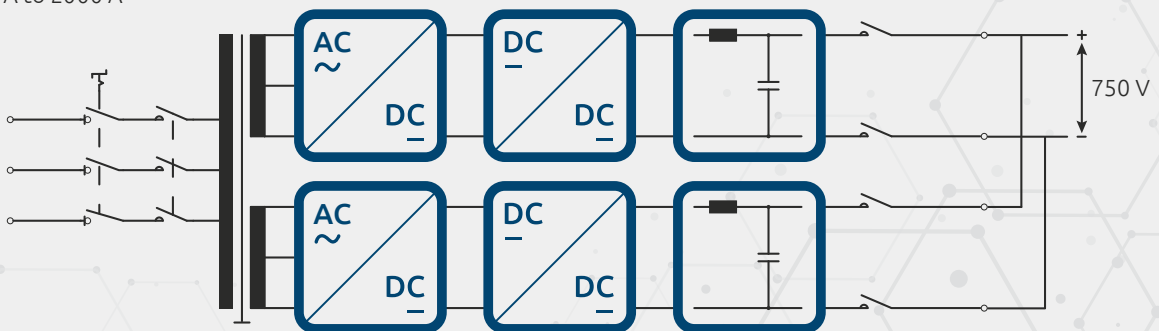

Standard features

The I-TS-3872 impresses even in the standard system configuration with its extensive equipment and is therefore ready for immediate use by customers from all over the world. The following is a small excerpt:

General information

- Input voltage 380 / 400 V, 50 / 60 Hz
- Sense connections for voltage measurement / regulation
- DC current and voltage measurement with 0.1 % full scale accuracy
- Switchable battery tester / battery emulator version
- Protection class IP54
- Liquid cooling
- Integrated water/water heat exchanger
- Plug and Play parallelization of two I-TS 3872 with the same technical data

Safety features

- Lockable main switch as load-break switch
- Safety control for Performance Level d in accordance with EN 60204-1 / ISO 13849-1.
- Voltmeter and indicator light in cabinet door
- Redundant DC output contactors
- Connection terminals for external „emergency stop“
- 2x connection terminals for external „Stop“
- 1x connection terminals for external „operating mode selection“
- DC output electrically isolated
- 2x insulation monitoring devices (separately switchable)

Interfaces

- 10 inch display with touch operation
- Modbus / TCP interface
- CAN interface
- VNC interface

Options (extract)

- 2x fieldbus interfaces EtherCAT or Profinet IO or Profibus DP (one per channel)
- Door lock
- Fail-safe feedback:
Emergency stop, stop, DC output contactors open (no individual selection possible)



General technical data-I-TS-3872

AC mains voltage / AC mains frequency	380 / 400 V ± 10 %, 3-phase, PE, 50 / 60 Hz ± 5 %
Measurement accuracy	Voltage: 16 Bit ADC // Current: 16 Bit ADC
Ripple voltage / current	≤ 0,1 % eff. fs
Voltage tolerance dynamic (0-100 % INom in 3 ms)	Battery tester < 3 % fs Battery emulator < 1 % fs
Short circuit performance	Short circuit proof: I _{sc} : 4,5 kA
Permissible environmental conditions: Storage as per EN 60721-3-1 Transport as per EN 60721-3-2 Operation as per EN 60721-3-3	1K21 / 1M11, +5 to +40 °C 2K12 / 2M4, -25 to +70 °C 3K22 / 3M11, +5 to +40 °C
Cooling method	Enforced liquid cooling (IP54)
Safety of machinery - Safety-related parts of control systems	EN ISO 13849-1 EN ISO 13849-2
Safety of machinery	EN 60204-1 Exception: • Sec. 11.3 Protection type see Techn. Data • Sec. 13.2 Identification of conductor
EMC standards	EN 61000-2-4 Class 3 EN 61000-6-2 EN 61000-6-4

Type

Power in kW

Current in A

Dimensions (W x D x H in mm)

Voltage range 2x 5 – 750 V / 1x 10 - 1500 V

I-TS-3872-1500-300-1000	300	1000	2400 x 800 x 2200
I-TS-3872-1500-600-1000	600	1000	4800 x 800 x 2200

References

Test and simulation systems



History

2023

75th anniversary of the Gustav Klein company



2022

Großer Preis des Mittelstandes – we are one of the nine best Bavarian companies

2018

New construction of a production hall with 2,000 m² in the Greifenstraße / Schongau



2016

Delivery of bidirectional inverters for the world's largest second life Energy storage from e-vehicle batteries

2013

Extension of the Office building in Im Forchet / Schongau

2012

Presentation of the first four-channel test and simulation system MI-TS

2007

Günther Stensitzki acquires the Gustav Klein company

1999

Delivery of pilot system for the development of electric vehicles



1997

The first energy storage units (250 kVA) for grid support were delivered

1989

Special inverter for room air conditioning

1986

Presentation of the first compact UPS system

1978

PWM inverters and switched-mode DC/DC converters

1977

Delivery of the first BEV systems (special backup power supplies) for hospitals

1969

Foundation of the branch in Inzing / Austria

1960

Presentation of the first thyristor rectifiers and thyristor inverters

1948

Company founded by Gustav Klein



Our Services

We don't just want to deliver our systems, we also want to take care of them. With our comprehensive range of services, we are always at your side and offer you customised solutions for your specific requirements.

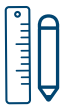

Customised adaptations & retrofits



Delivery & Commissioning



Training courses



24h hotline



Spare parts supply



Maintenance



Calibration of test systems



Renewal & modernisation of your power supply



Repairs on site & in the factory

Your reliable partner for power supply and power electronics

More than 400,000 systems have been delivered
in 105 countries worldwide.

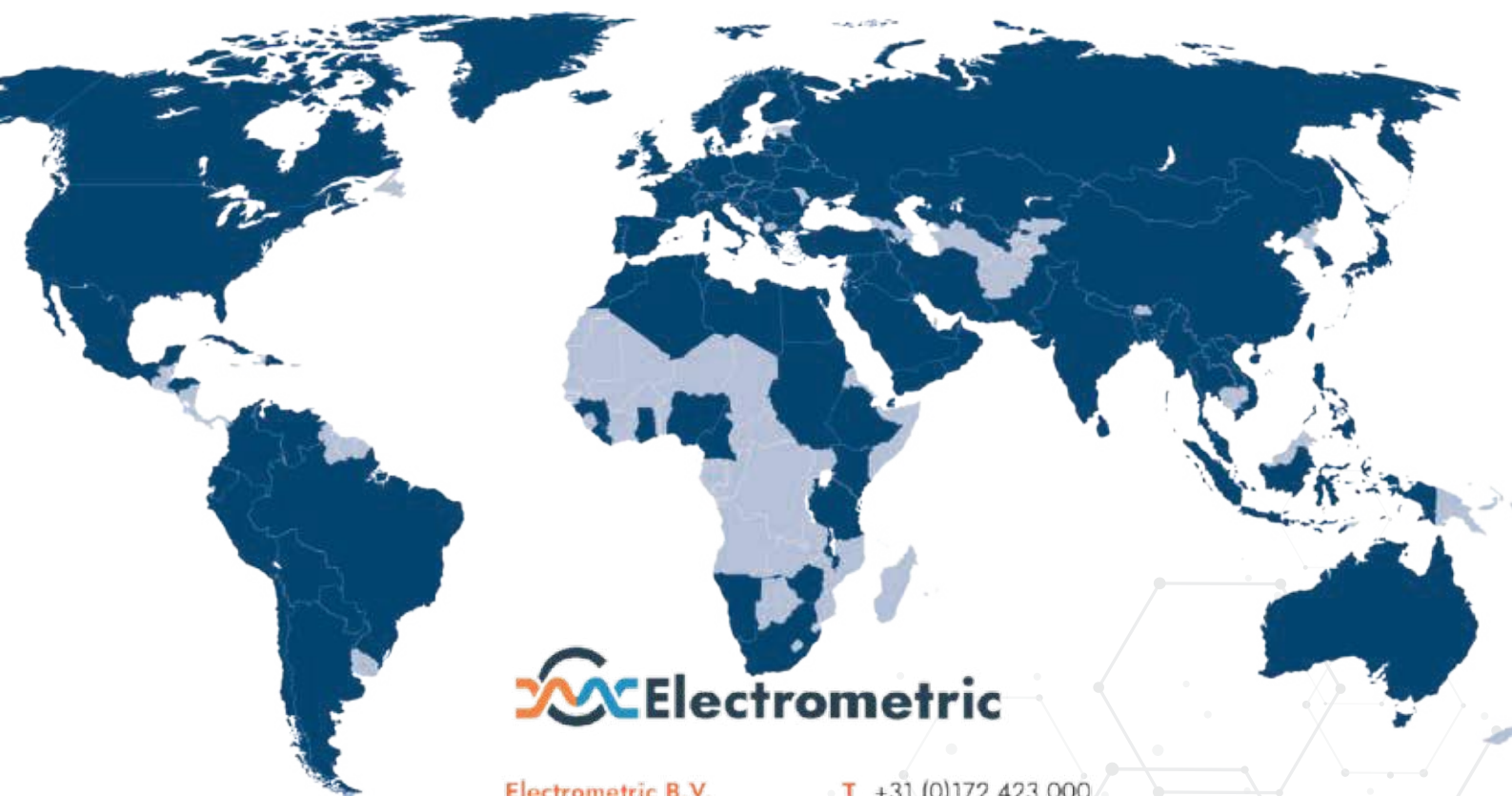

Electrometric B.V.

Frankrijcklaan 7
2391 PX Hazerswoude-Dorp
The Netherlands

T +31 (0)172 423 000

F +31 (0)172 423 009

info@electrometric.com

www.electrometric.com

■ Supplied countries worldwide

