



CIS-25 Data Sheets Conducted/Induced Susceptibility EMC Testing Kit

Kit Includes:

DSR 100-25 Test System

T 1000 Transformer

T 2000 Transformer

T 3700 Transformer

CR 600, Chattering Relay

Two Hours of Expert Consulting

Secure Storage Case

Plus all required cables and connectors

The **CIS-25 Test Kit** combines into a single, complete package the items needed to accurately test to important Aviation standards like DO-160 sections 18 and 19.

Included with the kit are three coupling transformers (T1000, T2000, and T3700), the CR 600 Chattering Relay accessory, and a secure storage cabinet to keep the equipment safe.

The CIS-25 kit also comes with two hours of expert consulting provided by EMC Specialist **Patrick G Andre**, who will answer any questions you might have about set-up or testing.

The DSR 100-25 test system, which is included with the CIS-25 Test Kit, has power in reserve. Each of our DSR Series models provides continuous DC power as rated, and is able to provide 4X rated power for in-rush testing up to 200 ms (such as is required in DO 160 Section 16). Plus, the DSR 100-25 system includes the complete 3110A Standard's Library, so the CIS-25 Test Kit can be used for many other tests.

The equipment is easy to set up and use; all elements in the kit are robust and will provide you with many years of trouble-free service.



DSR 100-25

Dropout, Surge, Ripple Simulator and AC/DC Voltage Source



Includes library of 1000+ pre-entered Automotive and Aviation Standards' test routines

Operate as a free-standing system using the included monitor, keyboard and mouse, or control via LAN



Very easy to modify existing tests or build new test sequences

Can function as a controller or node in a larger test system via built-in LAN and GPIO controls

Models from 15A to 200A continuous output current available

Key Performance Capabilities:

- 4-Quadrant Can source and sink current
- ±80V DC supply for 12V - 48V systems
- Meets 80V surge requirements
- 300 kHz Sine DC ripple tests for all major standards
- 3µs Rise time exceeds Surge and Drop-out slew rate requirements
- 3mΩ DC source impedance - better than ISO 7637-2 requirements

AE Techron's DSR 100 Series systems provide complete, single-box solutions for immunity testing. They include a simple-to-use yet powerful standards waveform generator matched with an industry leading power supply technology and come with an extensive library of tests for many automotive and aviation standards.

All models of the DSR 100 Series are 4-quadrant, allowing them to source and sink current. The DSR Series has power in reserve; each model provides continuous DC power as rated, and is able to provide 4X rated power for in-rush testing up to 200 mS, as is required in DO-160 Section 16.

Pre-entered tests for the following Industry standards:

- ANSI ASAE EP455 (Feb03)
- DO 160G (2012-12)
- ISO 7637-2 (2014) (E)
- ISO 7637-2 (2011) (E)
- ISO 16750-2 (2012-11) (E)
- ISO 21780:2020
- JASO D 001-94 (1994-03-31)
- MIL STD 461F (2007-12)
- SAE J1113-2 JUL2004
- SAE J1113-11 JUN2007
- SAE J2139 SEP2005
- SAE J2628 JUL2007

See page 2 for manufacturer-specific tests.

DSR 100 - 25

Output Current: 0A to 25A continuous

Peak Current: 50A for 200 ms

Bandwidth (-3dB), Full Signal: DC to 300 kHz, **Small Signal:** 20Vp-p to 1 MHz

Supply Voltage: Single-phase 120V \pm 10%, 30A, 50/60 Hz; 230V, 15A version available

Dimensions (DxHxW): 25 x 9.5 x 20 in. (63.5 x 24.1 x 50.8 cm)

Weight: Approximately 76.5 lbs. (35 kg)

Manufacturer Specific Standards

Audi I EE-32 (2006-06)

BMW GS 95003-2 (2010-01)

BMW GS 95024-2-1 (2010-01)

BMW GS 95024-2-2 (2011-01)

Case New Holland ENS0310 (12-2-2010)

Chrysler CS-11809 (2009-05-29)

Chrysler CS-11979 (2010-04-13)

Claas CN 05 0215 (2004-12)

Cummins 14269 (06201-028)

Cummins 14387 (102020-119)

DAF BSL-003 (1998-12)

DAF BSL-006 (2009-04)

Daimler Chrysler DC-10842 (2003-12)

Daimler Chrysler PF-9326 Change D

Fiat 9-90110 Issue 13 (2007-03)

Ford FMC1278

General Motors GMW3172_H (July 2010)

Honda 7794Z-SAAA-000 (28.12.2004)

Hyundai ES 39110-00 (2005-08)

Hyundai ES 95400-10 (2007-11-14)

Hyundai ES 96100-02 (2006-11-16)

Mazda MES PW67600 (1995-07)

Mitsubishi ES-X82010 Rev Q (2007-01)

Mitsubishi ES X82115 Rev C (2009-03)

Nissan 28400NDS02 Rev 3 (1999-07)

Nissan 28400NDS03 Rev 3 (2005-08)

Nissan 28401NDS02 Rev 4 (2008-08)

Toyota TSC70212G (2007-06)

Volkswagen VW 80101 (2009-03)

Volkswagen VW 80000 (2009-10)

Output Range: -80V to +80V

Source Impedance: 3 mV + 2.2 μ H

Operation: 4-quadrant, bi-polar operation

Output Rise Time: <3 μ S

Remote Control: GPIO, LAN

Cooling: Internal forced-air fans

Protection: Over/under voltage, over current, over temperature

Trigger: Automatic repeat, manual trigger, external trigger via GPIO or LAN

Input,

Signal In: BNC connector

LAN: Ethernet connector

Common Data (all models)

Output,

DUT Supply +/-: High-current connectors

Signal Output: BNC connector

LAN: Ethernet connector

Waveforms: Sine wave sweep, ripple (cranking), DC source, triangle wave, square wave, sawtooth wave

Control Functions: Trigger, fixed loop, variable loop, template playback, GPIO output, LAN output

Operating Environment,

Temperature: 10°C to 50°C (50°F to 122°F), Maximum Output Power de-rated above 30°C (86°F.)

Humidity: 70% or less, non-condensing

Atmospheric Pressure: 86 kPa (860 mbar) to 106 kPa (1,060 mbar)



230V & 400V versions of this product bear the CE mark



3110A Up to 1 MHz EMC Testing

Features

- Easiest-to-use LF wave sequence generator
- 3000+ automotive and aviation standard's tests included
- Dramatically reduces test time for repetitive test sequences
- Semi-automatic calibration routine significantly reduces labor-intensive tasks (like CS101)
- Very easy to modify included waveform sequences or create new ones



Microsoft
Partner

AE Techron's 3110A is a simple-to-use yet powerful standards waveform generator. It can be combined with other AE Techron products to quickly create a wide range of powerful and intelligent EMC test solutions.

The 3110A outputs a standard analog signal that can work with any AE Techron amplifier or other LF amplifiers that you already have. When coupled with the AE Techron model 7234 amplifier, the 3110A can create virtually all waveforms, DC offsets, dropouts and surges needed for EMC tests with rise/fall times of 2 μ s or greater and frequencies from DC to 1 MHz.

The 3110A software is built around the concept of a waveform segment. Each waveform segment can have a unique waveform, (sine, square, triangle, and/or DC offset). Frequency, amplitude and DC offset can be clipped, fixed, variable or swept. Segments can be calibrated (as required in CS101) and set to continue on to the next segment or to hold for an external trigger.

The power of the system occurs when waveform segments are linked to create test sequences. These test sequences can be of any length and can be run as a single sequence, looped, or looped with multiple variables changing within the test sequence (as required in multiple Toyota and GM standards). Finally, multiple sequences can be combined to create a single customized extended test.

An extensive library of 3000+ tests for many automotive, aviation and industry Standards makes it possible for the 3110A to save time from day one. And, for customers that require over-testing or testing for products that have no predefined standard, tests from the Standards Library can be easily modified and saved for later use.

The 3110A delivers extensive capabilities for LF EMC testing with very short training-time requirements. Plus, it makes it easy to automate repetitive and labor-intensive tasks, making the 3110A a very efficient and cost-effective solution for LF EMC testing.



HOW TO BUILD A TEST

Tests are created by combining wave segments together with other wave segments and/or control segments.

WAVE SEGMENTS (including sine, ripple, square, triangle, sawtooth, and DC offset) are the basic building blocks of each test.

The frequency, amplitude, and DC offset of each wave segment can be easily adjusted using the Wave Properties window and defined as fixed or linear, logarithmic or exponential sweep, with wave segment durations as short as 50 μ s.

CONTROL SEGMENTS like Fixed Loop, Variable Loop, and Trigger make the 3110A able to reproduce very complex standards. The test shown below highlights several key abilities made possible by these control segments.

A multi-step waveform can start at one level/condition, then be repeated, with up to four variables changing during the wave segment duration. Single or multi-step waveforms can be made to repeat (or loop) and these repeating waveforms can be nested within a larger simple or repeating waveform.

At any point during a waveform sequence, the program can be automatically paused (either holding the previous condition or muting) and wait for an external trigger before resuming.

THE RESULT is a complex waveform sequence that takes only minutes to setup, saving hours in both training and programming time compared to alternative EMC test generators.

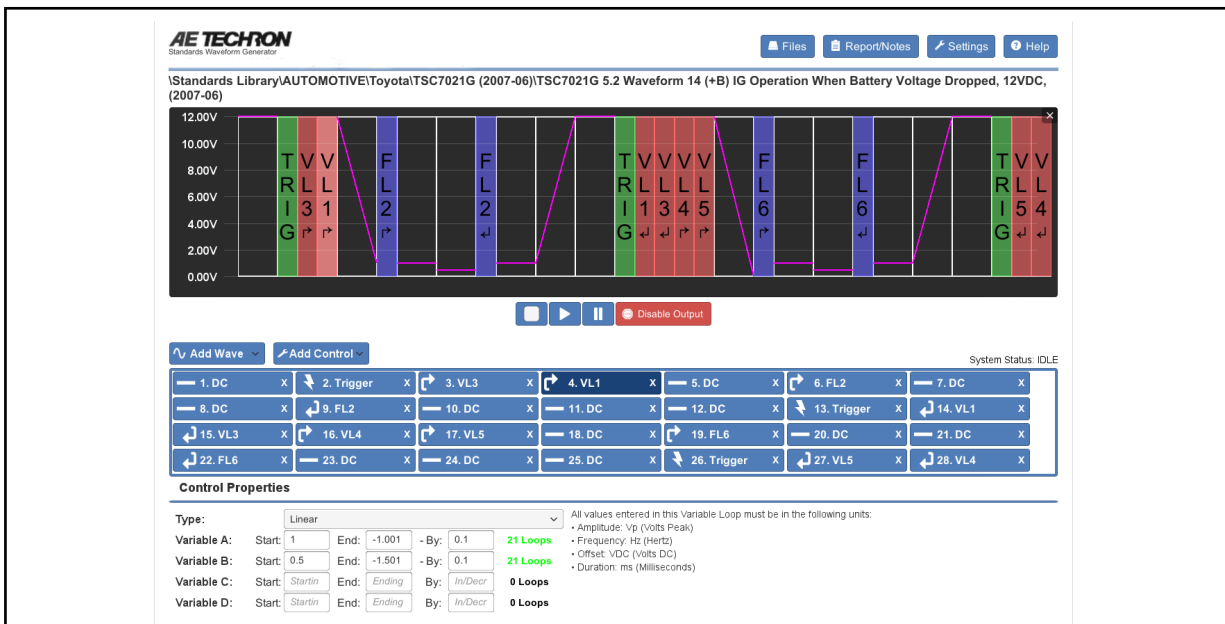

Technical Details - Hardware

Output channels: 1

Output Voltage: 10 Vp

Signal Generation:

DAC:

18 bit

DC – 20 kHz (any wave form)

3 μ s full scale (includes settling time)

Minimum pulse duration,

Burst: <15 μ s

Continuous: 30 μ s

Sine:

14 bit

DC – 1 MHz

400 Msp

0.01 Hz or better frequency resolution

.0002 degree phase granularity

Amplitude:

76 μ V resolution

Frequency,

Stability: \pm 50 ppm

Accuracy: \pm 0.1%

Control, Status, I/O

Front Panel:

On/Off/Breaker

Signal Output: BNC (analog - 10Vp)

LED Displays: Power, System Fault,
Signal-In Enabled

Back Panel:

Power Connection:

120VAC: IEC cable with NEMA 5-15

230VAC: IEC cable with CEE 7/7

Fuse: 2A, 250V slow blow (5 mm)

Physical Characteristics

Chassis:

The 3110A is designed for table-top or rack-mounted operation. The chassis is aluminum with a black powder-coat finish. The unit occupies two EIA 19-inch-wide units.

Weight: 9.5 lbs (4.31 kg)

Shipping Weight: 19.5 lbs (8.85 kg)

AC Power:

Single-phase, 120 VAC, 50/60 Hz, 2A service; 230 VAC, 50/60 Hz, 2A model available

Dimensions:

19 in. x 11.75 in. x 3.5 in.

(48.3 cm x 29.8 cm x 8.9 cm)

Technical Highlights – Software

Waveforms Supported:

Sine, Ripple, DC, Triangle, Square, Rectangle, Sawtooth

Waveform Modifiers:

Amplitude, frequency and DC offset (fixed or linear, logarithmic* or exponential sweep); phase angle; duration; clipped amplitude; and ripple on AC

Waveform Controls:

Trigger (user, GPIO, LAN), Fixed Loop, Variable Loop, Scripted Variable Loop, Template Playback, GPIO Output, LAN Output

Minimum Step Size (isolated):

25 μ s \pm 3 μ s

DC Quiescent Noise:

5 mV_{p-p}

Test Capabilities,

Minimum Waveform Duration: 50 μ s

Maximum Number of Loop Repeats: >1 million

Storage Capabilities, Number of Tests:

300,000 (expandable to 1 million)

See Capabilities sheet for loop characteristics

*Logarithmic sweep available for sine, ripple and DC offset waveforms only.

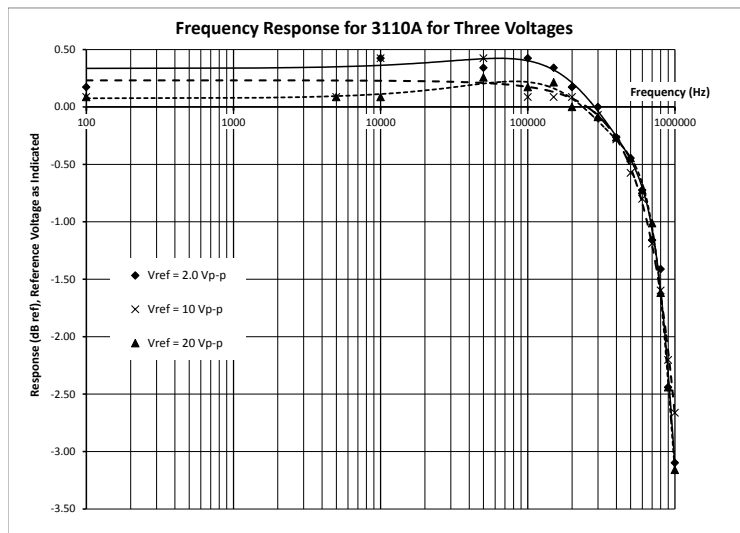

CE 230V versions of this product bear the CE mark

AE Techron Sales Representative



T1000 Transformer for Magnetic-Field Susceptibility Testing

For testing to these Specifications:

- DO 160 Section 19
- Boeing D6-16050-5 Section 7.2

Features

- Up to 100 A_{RMS} secondary current
- Exceeds AF Magnetic Field test requirements of DO 160 Section 19 and Boeing D6-16050-5 Section 7.2
- Circuit breaker protected from over-current
- Durable steel and high-density polyethylene case for impact resistance

The AE Techron **T1000 Magnetic-Field Susceptibility Transformer** was designed to exceed the AF Magnetic Field susceptibility test requirements of DO 160 Section 19 and Boeing D6-16050-5 Section 7.2.

It may also be used as 10-to-1 step-down transformer for output currents of up to 100 A_{RMS}.

The T1000 transformer provides up to 300 A-m and is able to generate up to 100A. The turns ratio provides a ten-to-one step down to the secondary winding.

The T1000 provides convenient input connectors via binding posts. Standard 0.75-inch spacing of binding posts allows use of standard plugs. Output is via 150A feed-through terminal block.

A 12-amp circuit breaker protects the unit against over-current conditions. A rugged, impact-resistant case and robust design protects the transformer from accidental damage.

The T1000 transformer is for use by experienced staff.

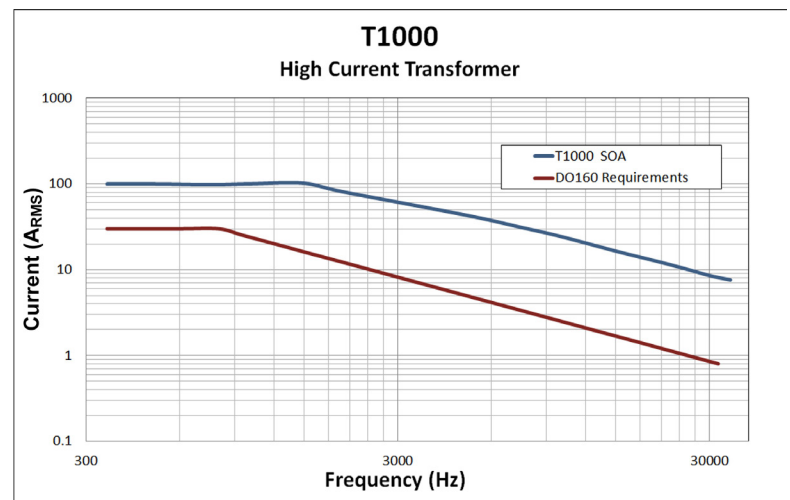

Figure 1 – T1000 Maximum SOA (safe operating area)

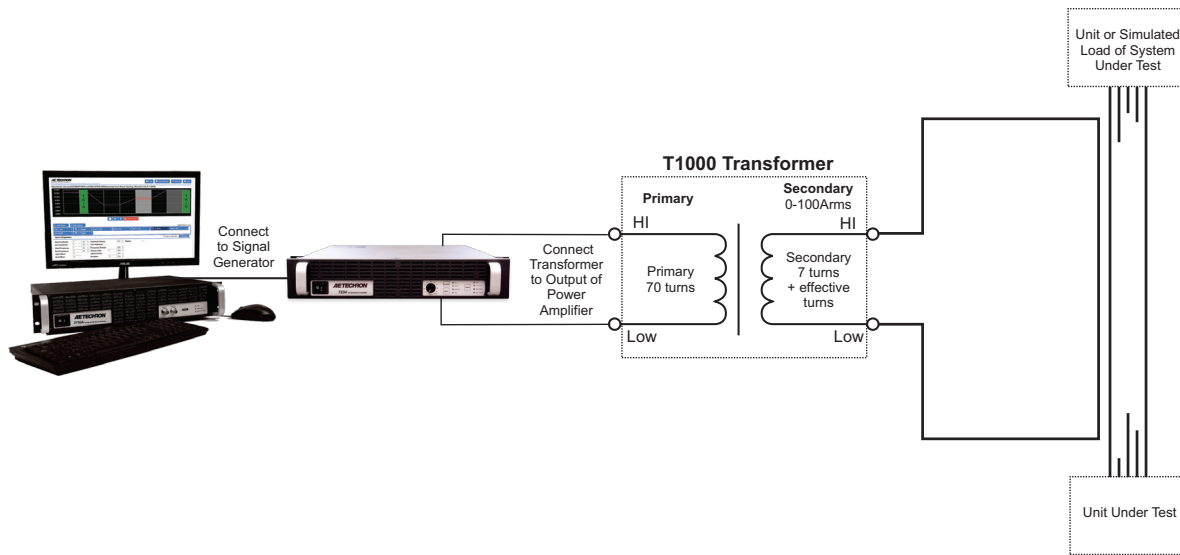

Figure 2 – Sample Application: DO 160 Section 19 Test Load Wiring

Specifications

Performance Specifications

Primary:

200 V_P maximum

Secondary:

20.0 V_P maximum output

Dielectric Test:

1200 VDC

Turns Ratio::

Ten-to-one step down

Protection:

Input power-protected via circuit breaker

Controls and Connectors

(see Figure 3)

Input Terminals:

4-way binding posts

Output Terminals:

Feed-through terminal block (150A); accepts up to AWG 1/0 wire.

Circuit Breaker:

Primary input limited to 12A; push to reset

Physical Characteristics

Case:

Steel interior shell with a durable external shell made from high-density polyethylene for impact resistance.

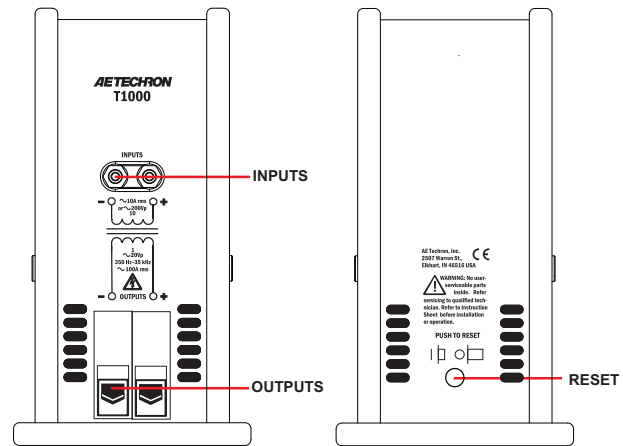

Figure 3 – T1000 Controls and Connectors

Operating Conditions,

Temperature: 10°C to 40°C (50°F to 104°F)

Humidity: 70% or less, non-condensing

Recommended Ambient Temperature:

25°C (77°F)

Cooling:

Natural air convection

Weight:

15 lbs. (6.8 kg)

Dimensions (HxWxD):

9.75 in. x 5.25 in. x 10.375 in. (24.8 cm x 24.8 cm x 13.3 cm x 26.4 cm)

AE Techron Sales Representative



T2000 Transformer for LF Conducted Susceptibility Testing

Features

- Frequency response – 10 Hz to 250 kHz
- Turns ratio – 2:1 step down
- Audio power – 200W MAX
- Meets the LF Conducted Susceptibility test requirements of DO 160 Section 18
- Circuit breaker protected from over-current on secondary
- Durable steel and high-density polyethylene case for impact resistance

For testing to these Specifications:

- Chrysler CS-11809 (2009)
- DaimlerChrysler DC-10615
- DO 160 Section 16
- DO 160 Section 18
- Ford FMC 1278
- GLloyd VI-7-2
- ISO 11452-10
- EMC-CS-2010JLR V1.1 (2011-01)
- MIL STD 461 D CS 101
- MIL STD 461 D CS 109
- MIL STD 461 E CS 101
- MIL STD 461 E CS 109
- MIL STD 461 F CS 101
- MIL STD 461 F CS 109
- MIL-STD-704
- Mitsubishi ES-X82115
- SAE J1113-2
- Tata TST/TS/WI/257

The AE Techron **T2000 Audio-Bandwidth Transformer** was designed to meet or exceed the LF conducted susceptibility test requirements of DO 160 Section 18. The T2000 is used to apply the required test signals to the lines under test for ripple voltage tests and continuous or transient conducted immunity tests.

It may also be used as 2-to-1 step-down transformer. The secondary can support up to 40 A_P.

The T2000 transformer supports up to 200W and is able to pass up to 40 A_P on the secondary. The turns ratio provides a two-to-one step down.

The T2000 provides convenient input connectors via binding posts. Standard 0.75-inch spacing of binding posts allows use of standard plugs. Output is via Multi Contact 125A plugs.

A thermal breaker protects the unit against over-current conditions on the primary. A 35A_{RMS} breaker protects the unit against over-current conditions on the secondary. A rugged, impact-resistant case and robust design protects the transformer from accidental damage.

The T2000 transformer is for use by experienced staff.

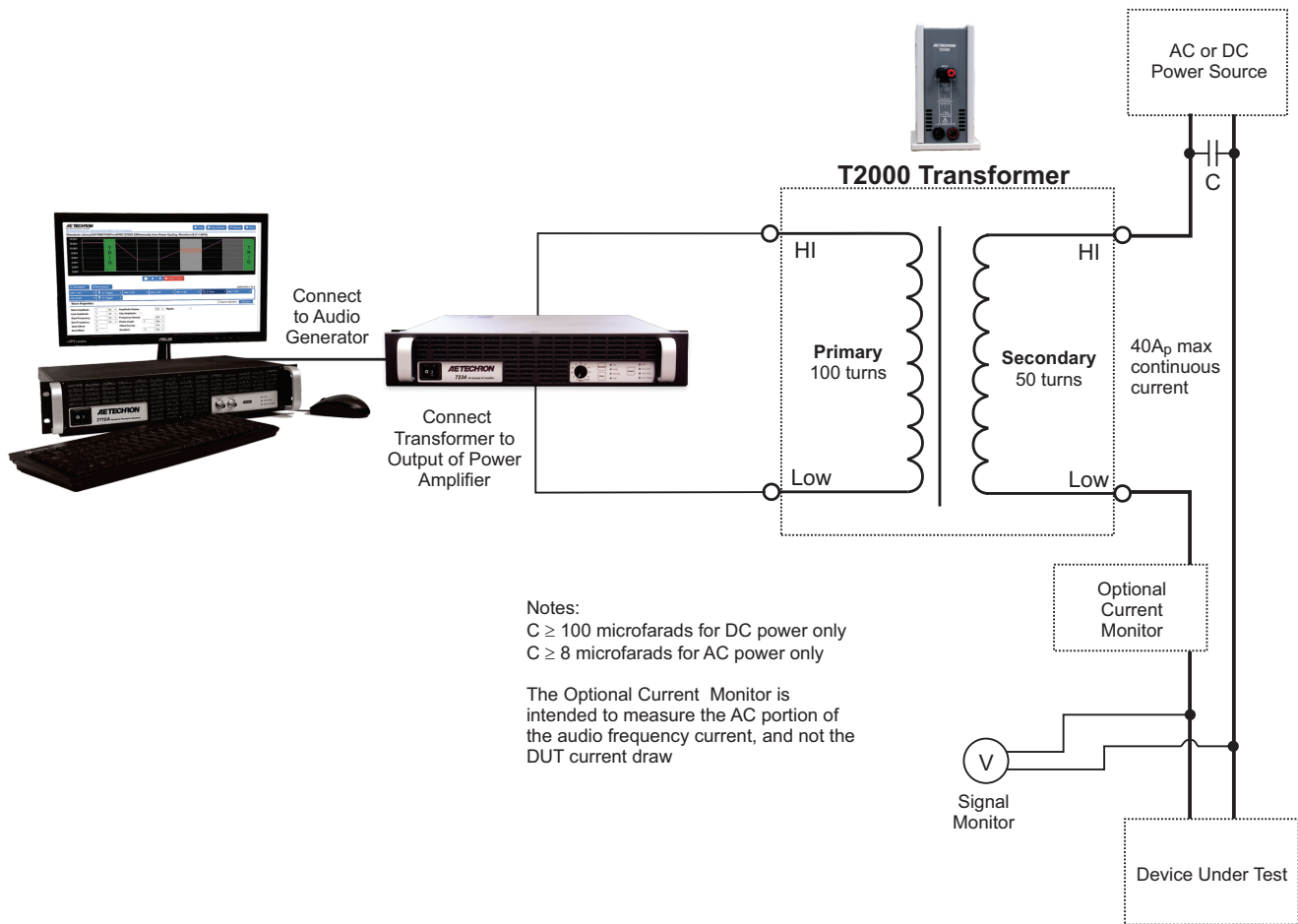

Figure 1 – Sample Application: DO 160 Section 18 Test Setup (for AC and DC power lines, differential mode)

Specifications

Performance Specifications

Transformer DC Resistance,

Primary:

0.076 ohms

Secondary:

0.021 ohms

Frequency Response:

10 Hz to 250 kHz

Audio Power:

200W

Dielectric Test:

1500 VDC primary to secondary

Secondary Saturation:

40A_p AC or DC maximum

Turns Ratio::

Two-to-one step down

Secondary Inductance:

Approximately 0.6 mH (unloaded)

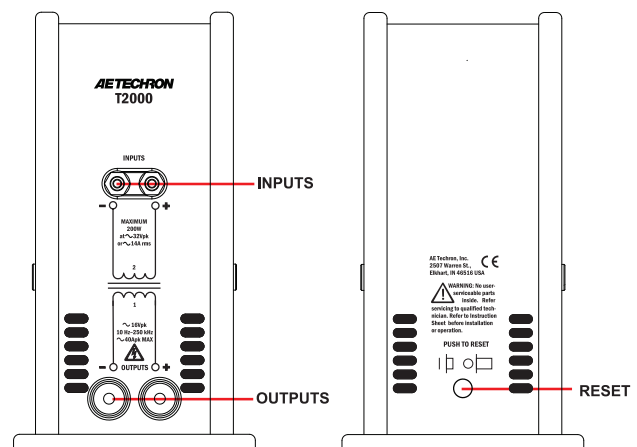

Figure 2 – T2000 Controls and Connectors

Protection:

Input power-protected via thermal breaker; secondary winding protected via 35A_{RMS} breaker

Controls and Connectors

(see **Figure 2**)

Input Terminals:

4-way binding posts

Output Terminals:

Multi Contact 125A plugs

Circuit Breaker:

Secondary winding limited to 35A_{RMS} via circuit breaker; push to reset.

Physical Characteristics

Case:

Steel interior shell with a durable external shell made from high-density polyethylene for impact resistance.

Operating Conditions,

Temperature: 10°C to 40°C (50°F to 104°F)

Humidity: 70% or less, non-condensing

Recommended Ambient Temperature:

25°C (77°F)

Cooling:

Natural air convection

Weight:

17 lbs. (7.7 kg)

Dimensions (WxDxH):

5.25 in. x 10.375 in. x 9.75 in. (13.3 cm x 26.4 cm x 24.8 cm)

AE Techron Sales Representative



T3700 Transformer for Electric-Field Susceptibility Testing

For testing to these Specifications:

- DO 160 Section 19
- Boeing D6-16050-5 Section 7.2

Features

- Up to 3,700 V_{RMS}
- Meets or exceeds voltage requirements of DO 160 Section 19 and Boeing D6-16050-5 Section 7.2
- Robust design, withstand tested to 5,000 VDC
- Durable steel and high-density polyethylene case for impact resistance

The AE Techron **T3700 Electric-Field Susceptibility Transformer** was designed to meet or exceed the voltage requirements of DO 160 Section 19 and Boeing D6-16050-5 Section 7.2 testing.

It may also be used as a 1-to-37 step-up transformer for voltages up to 3700 V_{RMS} .

The T3700 transformer is able to generate up to a 3700 V_{RMS} potential. It is withstand tested to 135% of rated output to ensure a long, trouble-free life. The turns ratio provides a 1-to-37 step up to the secondary winding.

The T3700 provides convenient input connectors via touch-proof, four-way binding posts. Standard 0.75-inch spacing of binding posts allows use of standard plugs.

A 1-amp fuse protects the unit against over-current conditions. A rugged, impact-resistant case and robust design protects the transformer from accidental damage.

The T3700's voltage output meets or exceeds the requirements of DO 160 Section 19 and Boeing D6-16050-5 Section 7.2. It is safe for use by experienced staff.

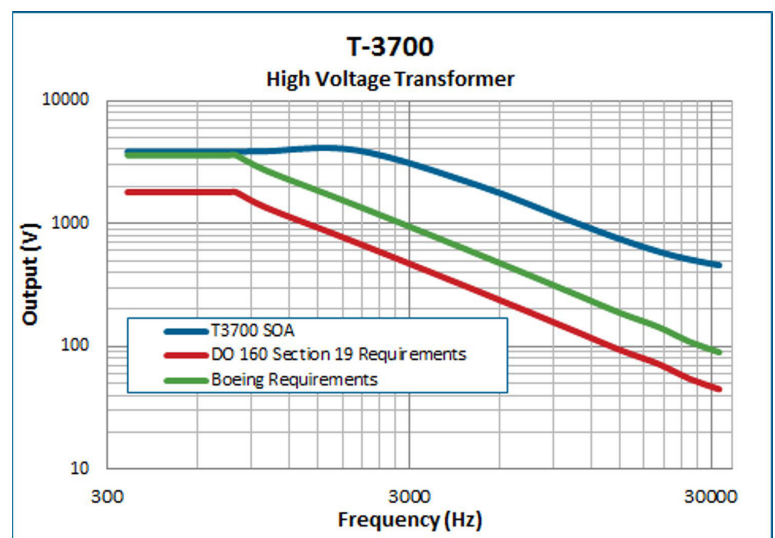

Figure 1 – T3700 Maximum SOA (safe operating area)

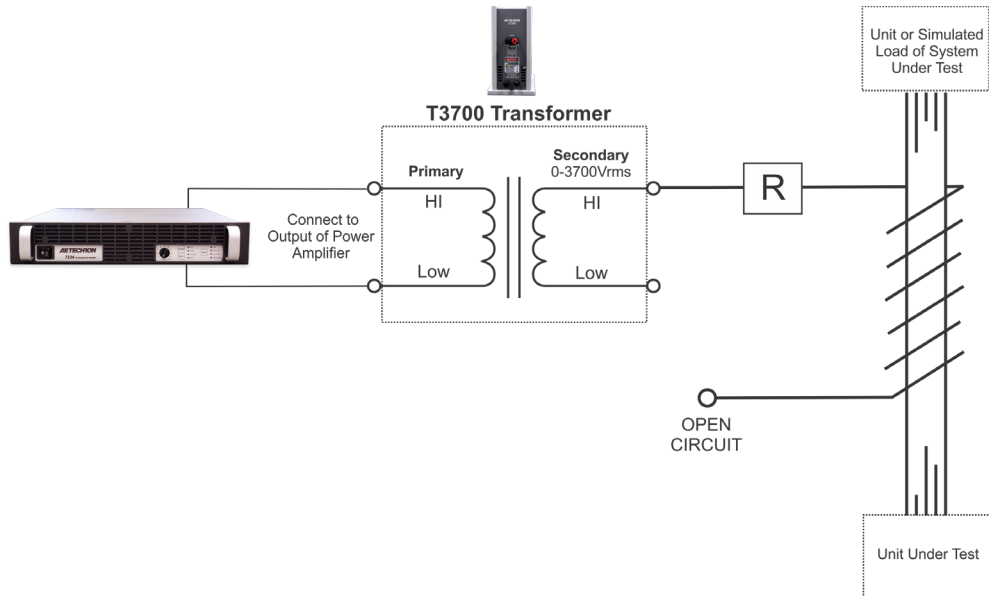

Figure 2 – DO 160 Section 19 Test Load Wiring

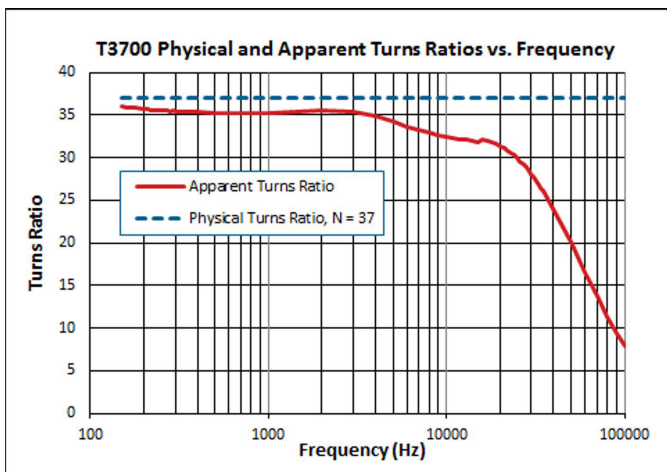

Figure 3 – Physical and Apparent Turns Ratios vs. Frequency

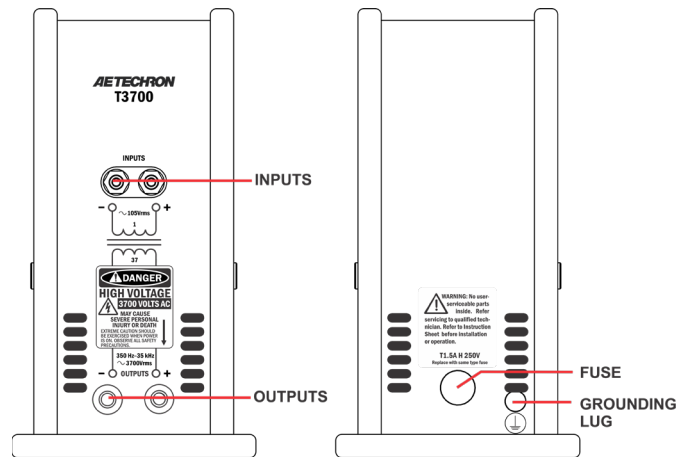

Figure 4 – T3700 Controls and Connectors

Specifications

Performance Specifications

Primary:

100 V_{RMS} maximum or 1 A_{RMS} , maximum

Secondary:

3700 V_{RMS} maximum output

Physical Turns Ratio:

1-to-37 step up

Dielectric Test:

5 kVDC primary to case

5 kVDC secondary to case

Frequency Range:

250 Hz to 35 kHz

Protection:

Current-protected input

Controls and Connectors

(see Figure 4)

Input Terminals:

4-way binding posts

Output Terminals:

LGH high-voltage connector (+)

Banana jack (-)

Over-Current Protection:

Primary input limited via fuse to 1A (T1A H 250V)

Grounding Lug:

Screw terminal grounding connector. Connect to earth ground using appropriate wire and connector.

Physical Characteristics

Case:

Steel interior shell with a durable external shell made from high-density polyethylene for impact resistance.

Operating Conditions,

Temperature: 10°C to 40°C (50°F to 104°F)

Humidity: 70% or less, non-condensing

Recommended Ambient Temperature:

25°C (77°F)

Cooling:

Natural air convection

Weight:

16 lbs. (7.3 kg)

Dimensions (WxDxH):

5.25 in. x 10.375 in. x 9.75 in. (13.3 cm x 26.4 cm x 24.8 cm)

AE Techron Sales Representative



CR 600 Chattering Relay

for DO-160 Section 19.3.5 Testing

Features

- Coil Voltage: 24 VDC
- Coil Current: 84 mA
- Contact Rating: 30A
- Typical Pulse Voltage: >700 Vpp
- Includes oscilloscope connection points for voltage monitoring

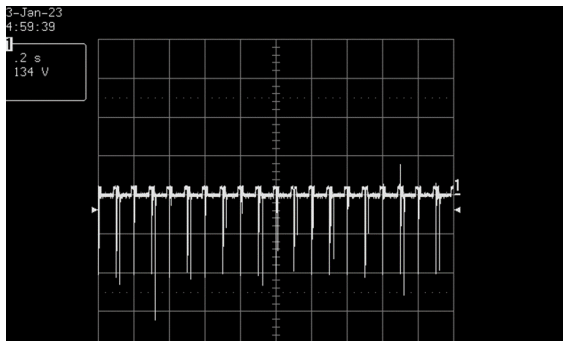

Figure 1 – Example of output from the CR 600 when adjusted to yield a pulse repetition rate of eight to ten pulses per second

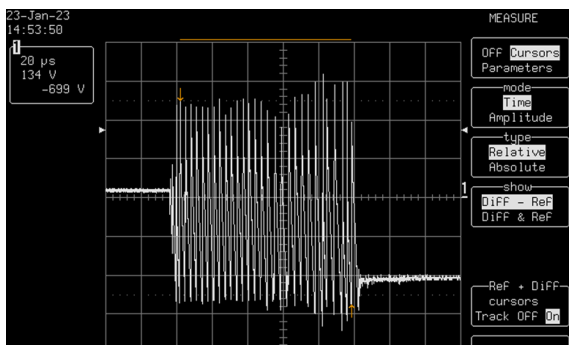

Figure 2 – Example of output from the CR 600 when adjusted for a pulse sequence with an amplitude greater than or equal to 600 Vpp, and a total duration of 50 to 1000 microseconds

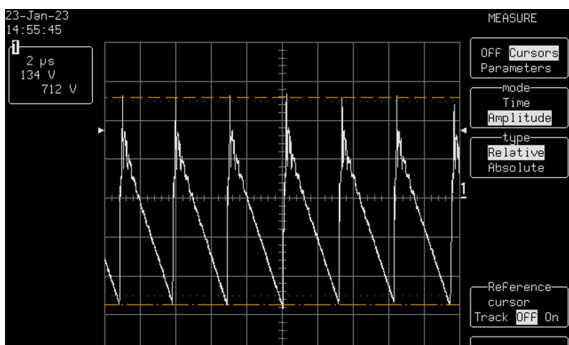

Figure 3 – Example of output from the CR 600 when adjusted for a repetition period of 0.2 to 10 microseconds

The AE Techron **CR 600 Chattering Relay** is a cost-effective, rugged yet elegant solution to the DO 160 Section 19.3.5 “Spikes Induced into Interconnecting Cables” test requirement.

Internally built around a 50A high-current relay with two independent sets of contacts, the CR 600 was engineered for double the life before refurbishment.

The CR 600 uses quick-connect, touch-proof connectors to ensure efficient setup and a safe test environment. It also includes quick-clip test points for oscilloscope monitoring of tests in progress.

When driven from an intermittent voltage source like the AE Techron DSR 100-25 and utilizing test waveform, “Section 19.3.5 CR 600”, the CR 600 output meets the voltage (600V), duration (50 – 1000 μs) and repetition-period (0.2 to 10 μs) requirements specified by the DO-160 standard.

For testing to these Specifications:

- DO 160 Section 19.3.5

Product Specifications

Performance

Coil Voltage: 24 VDC

Coil Current: 84 mA

Contact Rating: 30A

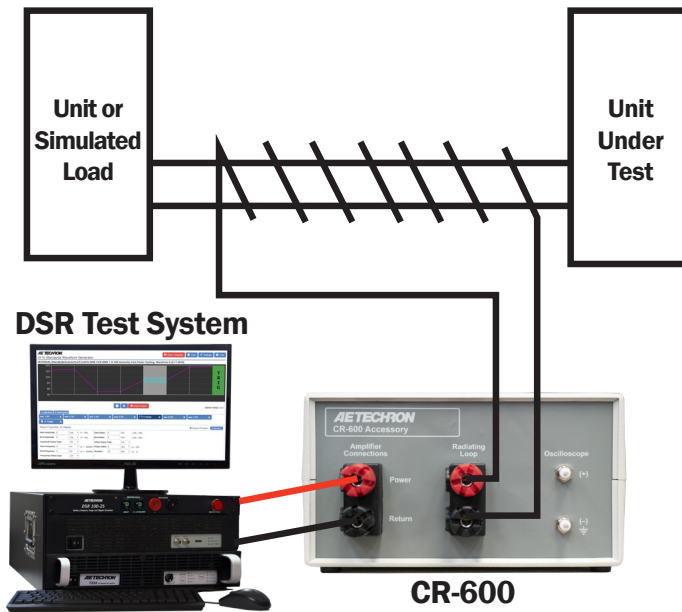

Figure 2 – Sample Application: Test Setup for RTCA DO160 Section 19.3.5 using the CR 600

Typical Pulse Voltage: >700 Vpp

Controls and Connectors

Amplifier Connections:

Dual binding posts

Radiating Loop:

Dual binding posts

Oscilloscope:

Dual turret connectors

Physical Characteristics

Case:

Injection-molded plastic

Operating Conditions,

Temperature: 10°C to 40°C (50°F to 104°F)

Humidity: 70% or less, non-condensing

Recommended Ambient Temperature:

25°C (77°F)

Cooling:

Natural air convection

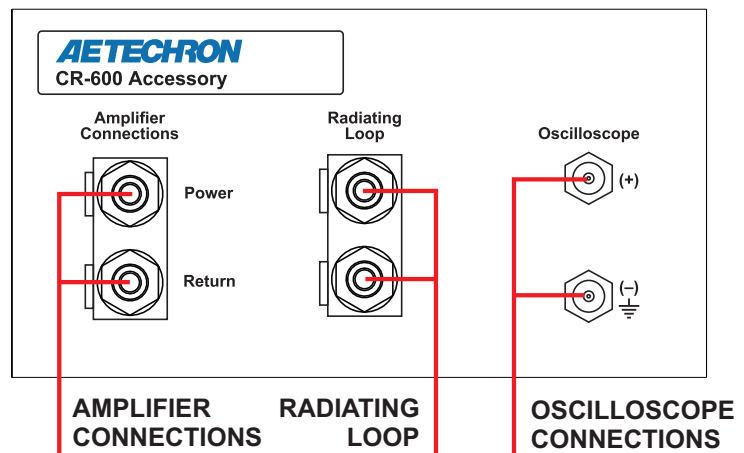

Figure 3 – CR 600 Connectors

Weight:

1.5 lbs. (0.68 kg)

Dimensions (HxWxD):

3.25 in. x 6.25 in. x 7.25 in. (8.3 cm x 15.9 cm x 18.4 cm)

AE Techron Sales Representative