

How to correctly use spectrum analyzers for EMC pre-compliance tests



Frankrijkklaan 7, ITC Boskoop
2391 PX HAZERSWOUDE DORP
The Netherlands
tel: +31 172 423 000
fax: +31 172 423 009
info@electrometric.com
www.electrometric.com

Index

- 1 Introduction2
- 2 Relevant standards2
- 3 Standard related requirements2
 - 3.1 Amplitude units.....2
 - 3.2 Resolution bandwidth2
 - 3.3 Frequency resolution4
 - 3.4 Sweep time.....6
 - 3.5 Detectors.....7
- 4 Internal attenuator, pre-amplifier9
- 5 Distortion considerations.....10
- 6 General sensitivity considerations11
 - 6.1 Conducted noise testing with LISN11
 - 6.2 Conducted noise testing with RF current probes12
 - 6.3 Radiated noise testing with TEM-cells13
 - 6.4 Radiated noise testing with antennas.....14
- 7 Input protection15
- 8 History18

How to correctly use spectrum analyzers for EMC pre-compliance tests

1 Introduction

A spectrum analyzer is a key instrument for conducting EMC testing. Analyzers with EMC-specific features have become very affordable in recent years and these are usually sold as “EMI-options” that typically include CISPR filters and Quasi-Peak (QP) detectors in addition to the standard features of spectrum analyzers.

Spectrum analyzers offer a wide range of parameter settings and need to be set up correctly in order to make measurements as close as possible to the requirements of the specific EMC standards that apply to the product’s design and end-use. EMC standard-related requirements determine the correct instrument settings of the RBW filter, video bandwidth (VBW), detector type, frequency span, and sweep time.

Radiation limits and transducer characteristics also affect the required settings. Optimizing the instrument is necessary to achieve a good compromise between high sensitivity and low distortion.

Measurement plots documented in this application note are created using a Siglent SSA3021X Plus, an entry-level EMI- spectrum analyzer with an excellent price-performance ratio.

2 Relevant standards

Several standards specify EMC test set ups and requirements for measurement equipment. Most prominent are the CISPR 16 and EN 61000-4 series. There are additional relevant standards, such as CISPR 25, Mil-461, DO 160 and more. This document is mainly focused on the CISPR 16 standard to keep this application note as compact as possible.

3 Standard related requirements

3.1 Amplitude units

In RF applications, [dBm] is the predominant amplitude unit. [dBm] is a logarithmic power unit, which makes sense, as input and output impedance of RF building blocks are typically designed to 50 Ohm.

In EMC pre-compliance applications, the impedance of EUTs and power supply sources is hardly predictable. Consequently, emission limits are predominantly specified in [dB μ V] and [dB μ A] amplitude units. Standardized transducers such as Line Impedance Stabilized Networks (LISNs), Coupling/Decoupling Networks (CDNs), RF current probes, and others are used to establish interfaces with defined impedance, in order to connect 50 Ohm measurement equipment.

3.2 Resolution bandwidth

Typically, the resolution bandwidth filters on spectrum analyzers use Gaussian shaped intermediate frequency (IF) filters with adjustable bandwidths that follow a 1 -3 -10 sequence, e.g. 100 Hz, 300Hz, 1 kHz, 3kHz, 10 kHz, 30 kHz...

In order to be compliant with CISPR standards, the spectrum analyzer must additionally provide so called CISPR-filters. Many analyzers use a Gaussian filter by default, so the user should select the EMI filter option if required.

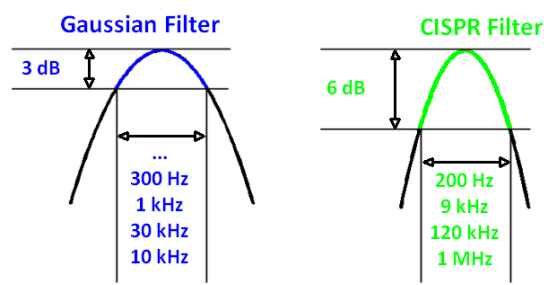

How to correctly use spectrum analyzers for EMC pre-compliance tests

Besides specifying filter shape, impulse response and side lobe suppression, CISPR specifies frequency bands and the corresponding filter bandwidths that have to be used:

Frequency range	CISPR filter bandwidth
9 kHz – 150 kHz	200 Hz
150 kHz – 30 MHz	9 kHz
30 MHz – 1 GHz	120 kHz
Above 1 GHz	1 MHz

The smaller the resolution bandwidth (RBW), the lower the base noise level. The base noise level is a function of the measurement instruments Displayed Average Noise Level (DANL), the measurement transducer/antenna/probe, and the environmental RF present during the measurement. You may already have observed steps in test house plots, which are caused by switching filter bandwidth. Figure 2 below shows an example of such a step where the RBW was changed from 9 kHz in the first part of the sweep to 120 kHz after 30 MHz:

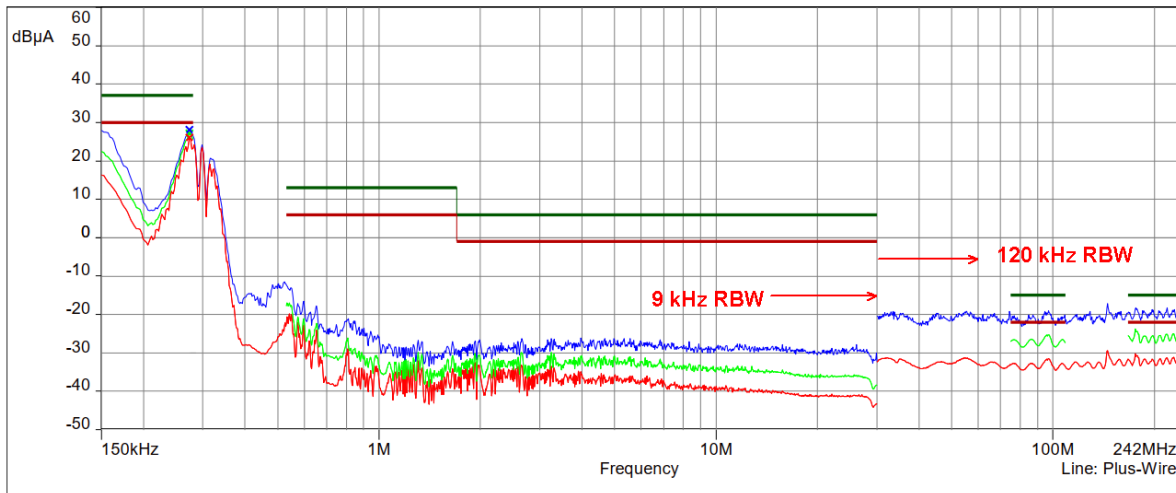

Transition from 9 kHz to 120 kHz RBW at 30 MHz – step in base noise level

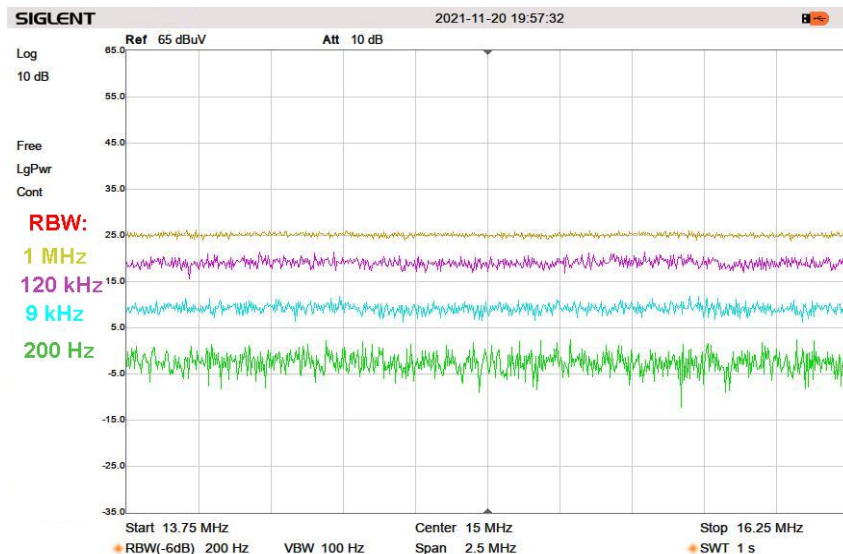

Spectrum analyzer base noise level versus resolution bandwidth

How to correctly use spectrum analyzers for EMC pre-compliance tests

3.3 Frequency resolution

Spectrum analyzers sweep the frequency range in discrete steps. Typically, the number of frequency steps per sweep is identical to the number of display pixels in X-direction. The Siglent SSA3021X, as an example, has a resolution of 751 equidistant frequency points per sweep. Other common spectrum analyzers have 601 measurement points per sweep.

Spectrum analyzer usually power up with the sweep set to full span and the RBW set to 1 MHz.

When feeding the analyzer with a signal, it may be observed that frequency and amplitude are not displayed correctly. A brief calculation and looking at the filter curves and spacing between adjacent frequency points and the reason becomes obvious. As an example, what if we divide the measurement span of 2.1 GHz by 751 frequency points? This results in adjacent frequency points being spaced by approximately 2.8 MHz:

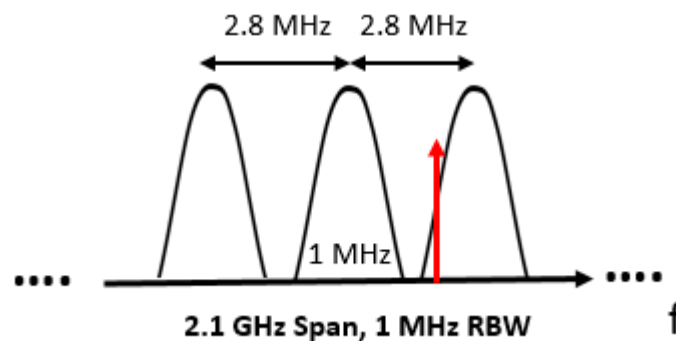

Input signals may fall in between two adjacent filter curves or into the shoulder of a filter curve. Consequently, the signal will be attenuated and the analyzer display would show a lower amplitude value – the measurement value would be incorrect. The displayed frequency will be corresponding with the center frequency of the closest measurement frequency point and the offset would be incorrect as well.

Let's take another example and look at a typical conducted emission measurement. In most cases, this measurement covers the frequency range up to 30 MHz and requires a CISPR RBW of 9 kHz. Attempting to make a full sweep across the entire 30 MHz results in a spacing of $30 \text{ MHz} / 751 = 39.9 \text{ kHz}$. A significant part of the spectrum would not be measured at all:

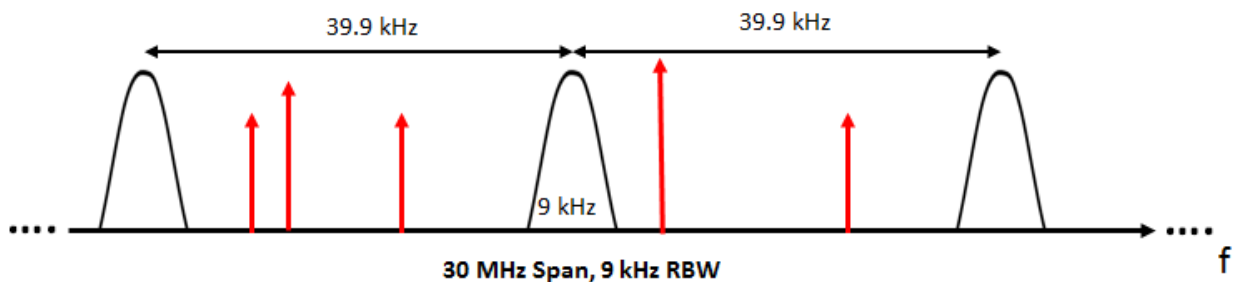

How to correctly use spectrum analyzers for EMC pre-compliance tests

In order to cover the entire spectrum within the span of a frequency sweep, CISPR 16 specifies that adjacent frequency points shall not be spaced more than half of the resolution bandwidth. In case of the example above, the spacing shall not be more than $9\text{ kHz} / 2 = 4.5\text{ kHz}$.

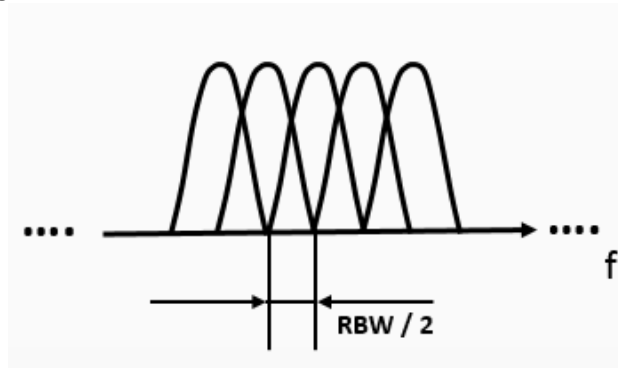

With this information in mind, the frequency span settings have to be chosen in order to fulfill the frequency spacing and RBW specifications of CISPR 16:

Number of measurement points per sweep: 751 (Siglent SSA3021X)		
Frequency range	CISPR filter bandwidth	Maximum frequency span
9 kHz – 150 kHz	200 Hz	75 kHz
150 kHz – 30 MHz	9 kHz	3.38 MHz
30 MHz – 1 GHz	120 kHz	45 MHz
Above 1 GHz	1 MHz	375 MHz

Consequently, a conductive emission measurement for the frequency range 150 kHz to 30 MHz has to be split into at least $29.85 / 3.38 = 9$ segments with a span of 3.38 MHz.

Doing such a measurement manually, would be a tedious process. Various analyzers let you increase the default number of measurement points to a higher value. Newer analyzers also offer the capability to select standard conformant EMI measurement routines, which also ensure that adjacent measurement points have the correct frequency spacing. The disadvantage is that the resulting graph is still limited to the number of available display pixels.

Tekbox offers EMCview, an EMI measurement software, which splits the measurement into consecutive sweep segments. The measurement values of all sweeps are then stitched together to a single graph for easy analysis and reporting. EMCview also simplifies EMI measurements by providing a vast list of preconfigured measurements.

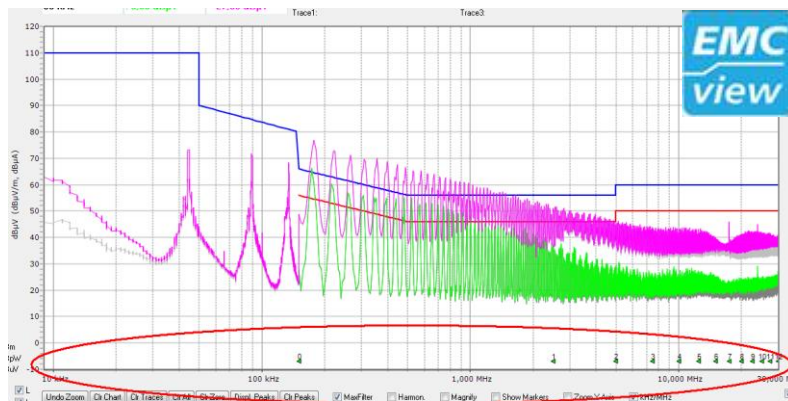

Conducted noise measurement with EMCview.

The 30 MHz sweep is built from 12 segments with a 2.5 MHz span each

How to correctly use spectrum analyzers for EMC pre-compliance tests

3.4 Sweep time

CISPR 16 differs between wideband and narrowband noise. Narrowband noise is typically caused by clock signals. Wideband noise is caused by data signals. As the spectrum of data signals is caused by a more or less arbitrary bit sequence, it is dynamic and wideband. Furthermore, signals may be present or not, depending on tasks running on the controller. Sweeping too fast would miss pulses and not correctly measure the wideband noise spectrum.

Consequently, **CISPR 16** specifies **minimum** sweep times, depending on frequency range and detector:

Frequency range	Peak detector	Quasi-peak detector
9 kHz – 150 kHz	100 ms / kHz	20 s / kHz
150 kHz – 30 MHz	100 ms / MHz	200 s / MHz
30 MHz – 1 GHz	1 ms / MHz	20 s / MHz

CISPR 25 specifies **minimum** sweep times below:

Frequency range	Peak detector	Peak detector	Quasi-peak detector
150 kHz – 30 MHz	10 s / MHz	10 s / MHz	200 s / MHz
30 MHz – 1 GHz	100 ms / MHz	100 ms / MHz	20 s / MHz
above 1 GHz	100 ms / MHz	100 ms / MHz	n.a.

Longer sweep times have an averaging effect, reducing the noise level:

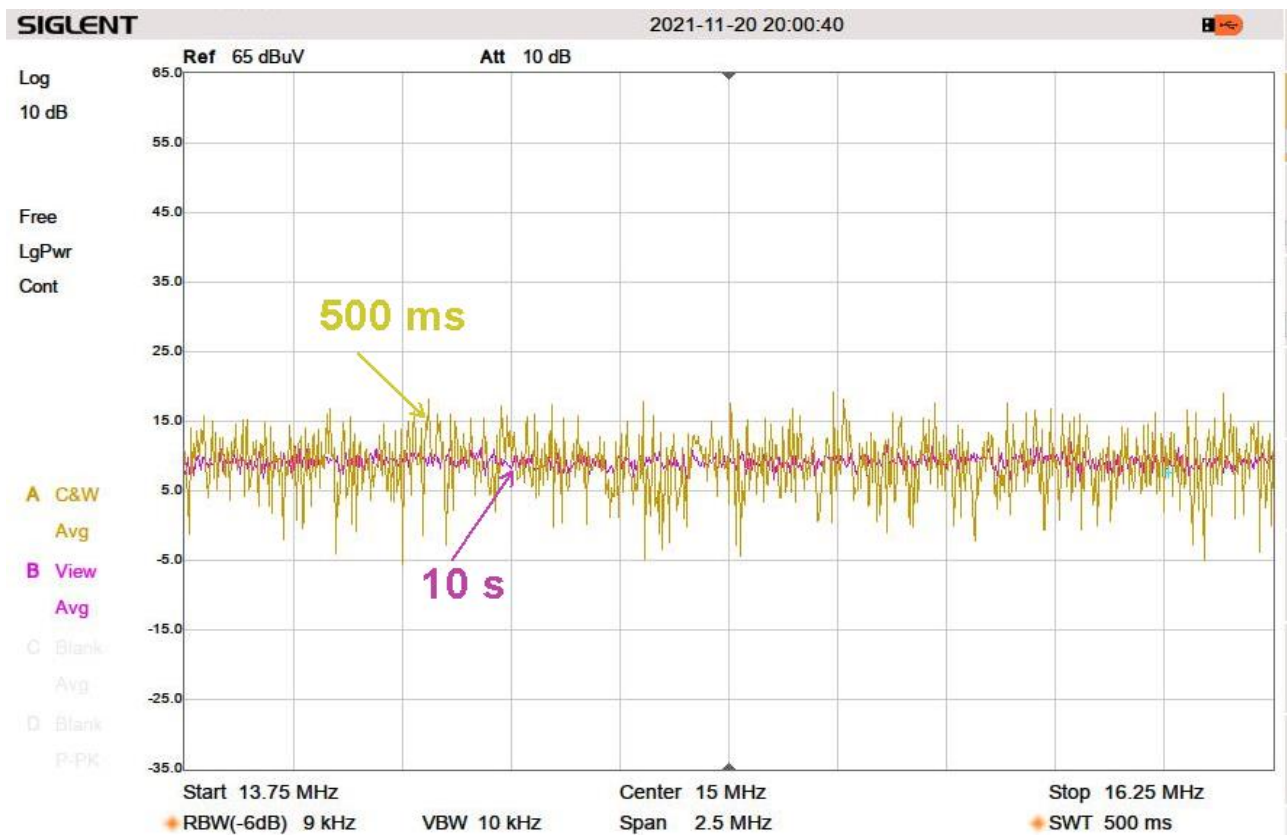

Analyzer base noise (DANL) with 500 ms sweep time versus 10 s sweep time

How to correctly use spectrum analyzers for EMC pre-compliance tests

3.5 Detectors

Most conducted and radiated emission tests have limits specified for average detector and quasi-peak detector.

Whereas measurement scans with average and peak detector can be carried out reasonably quickly, quasi-peak detectors require a measurement time of 1 second per measurement point for measurement receivers and similarly long time for spectrum analyzers. A single, complete measurement scan may take several hours, when carried out with quasi-peak detectors.

However, there is a workaround, which reduces measurement time significantly:

The measurement result of the peak detector is always higher than the measurement result of the average detector.

The measurement result of the quasi-peak detector will always be somewhere in between the results of the average and peak detector. The measurement result of the quasi-peak detector will never be higher than the measurement result of the peak detector.

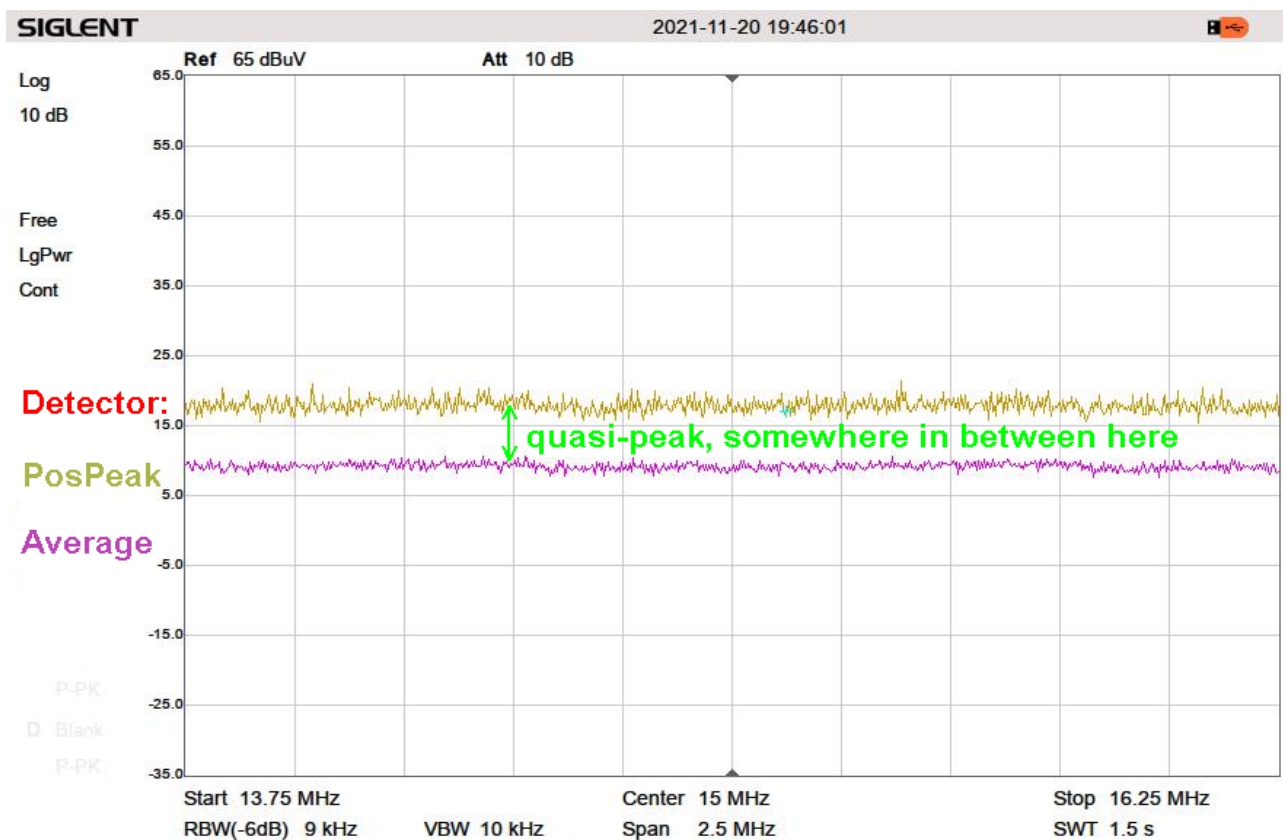

Consequently, a complete scan will be carried out, using the peak detector and the result will be compared against the quasi-peak limits. If the peak detector measurement is within QP limits, the EUT has passed the test. If the peak detector result has a few spurious, which cross the limit line, there is still the chance that the quasi-peak result is within the limits. However, if the spurious is 10 dB or more above limits, the chance is pretty slim.

To verify, a selective re-measurement, using quasi-peak detector, will be carried out at only the frequency points, where the peak detector measurement crosses the limit line.

When selectively re-measuring spurious peaks with critical amplitudes, it also needs to be considered that the spurious peaks may have drifted in frequency in the time that passed between peak detector measurement and selective re-measurement with the quasi-peak detector. Peaks originating from switched-mode regulators may drift considerably over time and temperature. Doing a selective re-measurement may completely miss the spurs at a later time or have the spur frequency offset far enough

How to correctly use spectrum analyzers for EMC pre-compliance tests

to obtain a wrong measurement result. EMCview offers a selective measurement option considering frequency drift. Instead of just measuring at a single frequency, the quasi-peak measurement can be carried out across several adjacent frequency points. EMCview will then make a peak search through these frequency points to ensure capturing the correct quasi-peak amplitude.

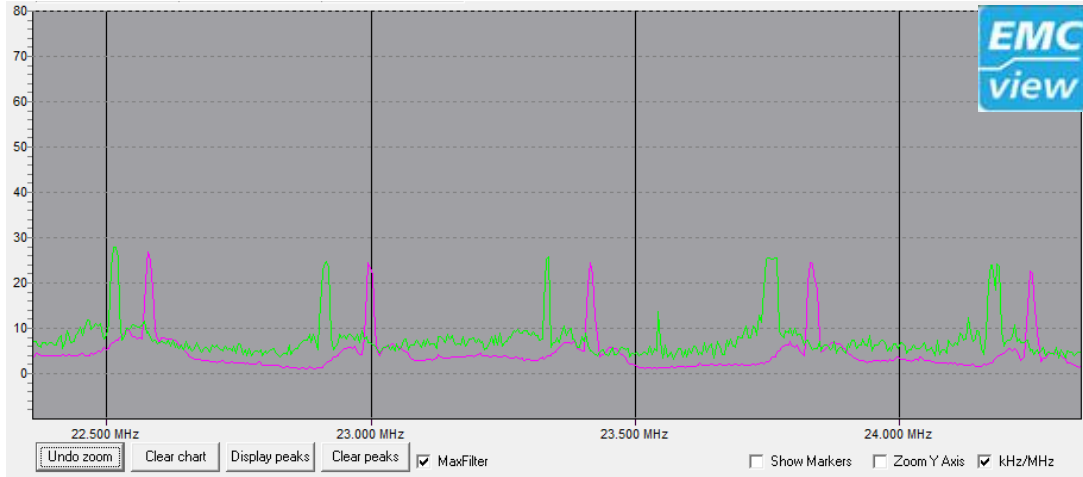

Example of spurious drifting over time. Both measurements were taken with the same settings, but with a time difference of 15 minutes.

The screenshot below shows a plot from a test house showing the concept of selective quasi-peak measurement. The orange graph shows the peak detector measurement with the blue markers at the frequencies, where the quasi-peak limits are violated. The red markers show the results of selectively re-measuring with quasi peak detector.



How to correctly use spectrum analyzers for EMC pre-compliance tests

4 Internal attenuator, pre-amplifier

When setting up the spectrum analyzer for any EMC measurement, careful choice of internal attenuator settings is essential.

The screenshot below shows the effect of the internal attenuator and pre-amplifier settings on the base noise of the spectrum analyzer.

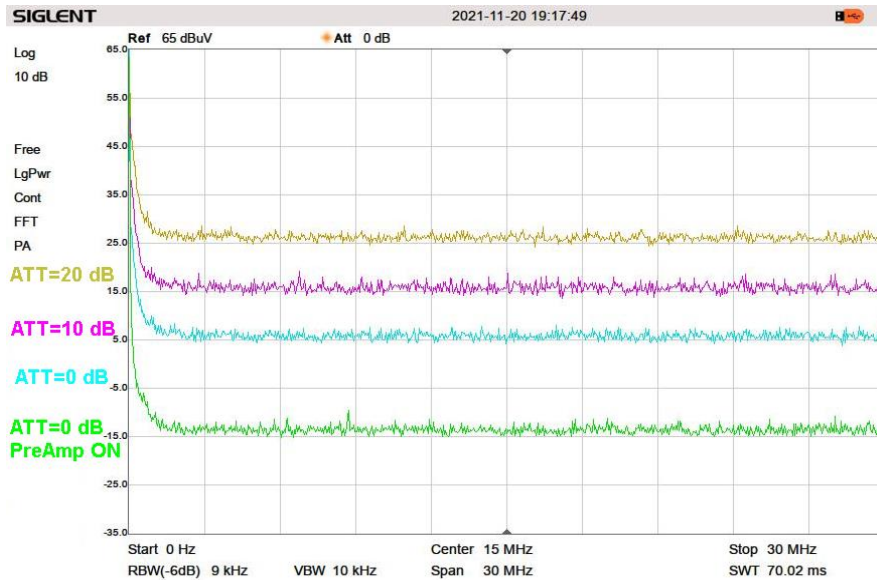

Spectrum analyzer DANL versus internal attenuator / pre-amplifier settings.
RF input terminated with 50 Ohm

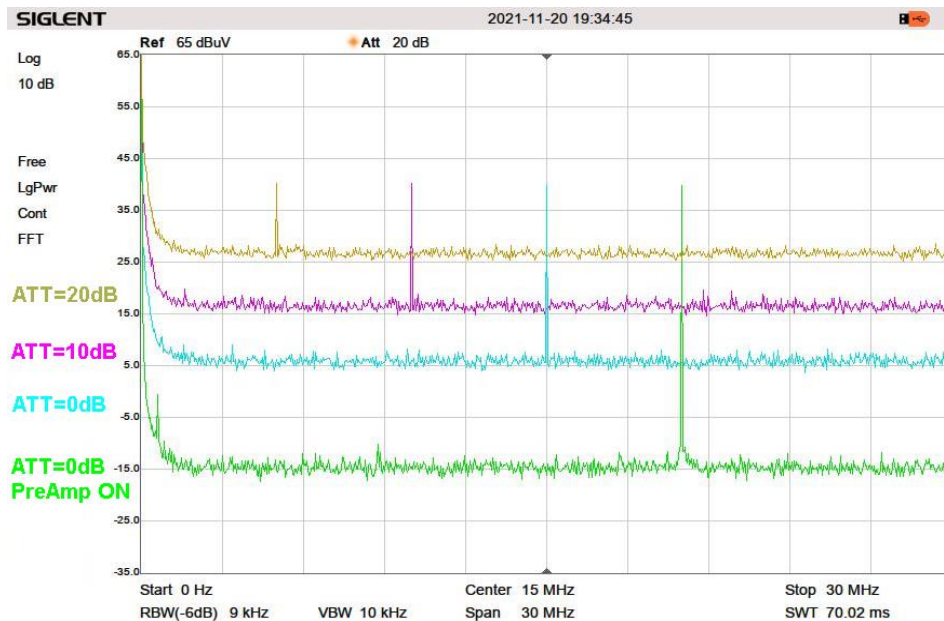

Spectrum analyzer base noise versus internal attenuator / pre-amplifier settings. RF input fed with CW signal; constant amplitude, but shifted 5 MHz at each setting for better visibility

How to correctly use spectrum analyzers for EMC pre-compliance tests

When performing conducted emission testing, there is a high probability for high amplitude spurs. Choosing 0 dB attenuation and eventually turning on the pre-amplifier at the same time may cause intermodulation distortions and/or ADC saturation. Consequently, the default settings for most conducted emission tests in EMCview are 20 dB internal attenuation and pre-amplifier off. Some standards, however, such as CISPR 25 Class 5 conducted emissions, voltage method, have very low limit levels and require less internal attenuation.

Radiated emission measurements require very high sensitivity. Corresponding default EMCview project settings are typically 0 dB internal attenuation and pre-amplifier on.

CISPR 16 specifies that the base noise of the measurement setup has to be at least 6 dB below the limit lines in order to have sufficient dynamic range to reliably measure critical spurious.

5 Distortion considerations

The spectrum analyzer itself may produce distortion products, and potentially disturb measurements, if strong signals are applied to the RF input. As spectrum analyzers contain components with non-linear behavior such as mixers and amplifiers, they will always generate some distortion products. This internal distortion can, at worst, completely cover up the distortions created by the Equipment Under Test (EUT).

The user needs to understand how distortion is related to the input signal, to determine for a particular measurement, whether or not the distortion caused by the analyzer, will affect the measurement.

The dominant non-linear distortions are second-order and third-order harmonics.

The second-order distortion increases as a square of the amplitude of the fundamental signal, and the third-order distortion increases as a cube.

When the fundamental power is in/decreased 1 dB, the second-order distortion in/decreases by 2 dB. When the fundamental power is in/decreased 1 dB, the third-order distortion in/decreases 3 dB. Using attenuators, it can be determined whether any spurious come from the signal source or whether they are generated by the spectrum analyzer.

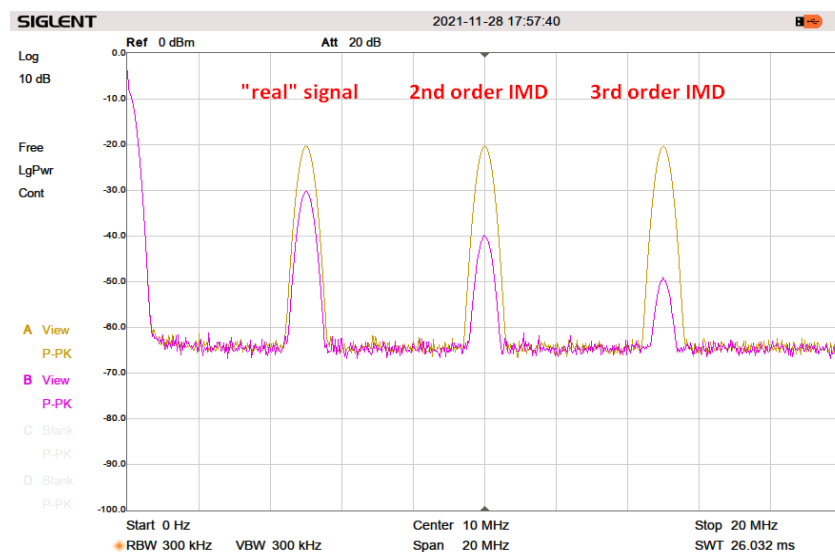

Adding a 10 dB external attenuator to validate a signal with respect to intermodulation distortion

How to correctly use spectrum analyzers for EMC pre-compliance tests

6 General sensitivity considerations

6.1 Conducted noise testing with LISN

Example CISPR 32 Class A, conducted emissions, mains supply line:

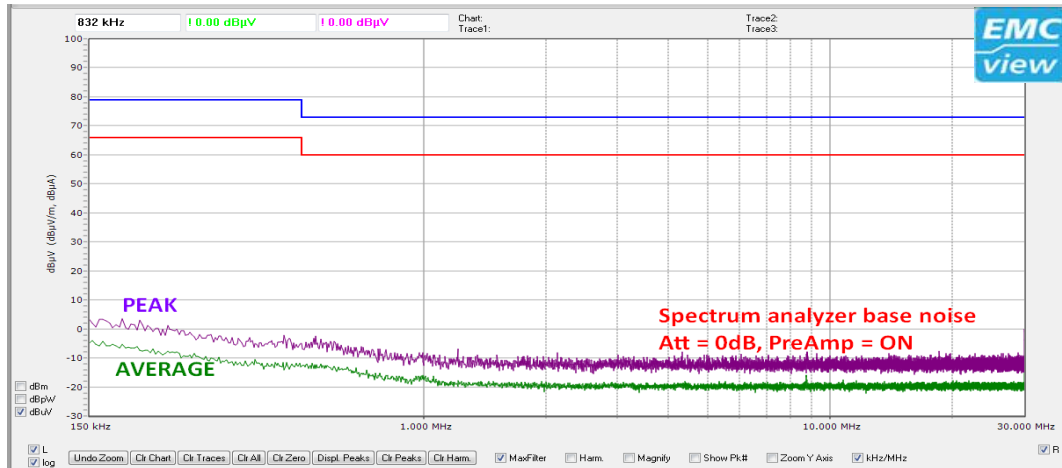

When choosing the amplitude settings of the spectrum analyzer, compare the limit lines against the DANL of the analyzer. The screenshot above shows that there is 80 dB of dynamic range between limit lines and DANL, if the analyzer will be set to maximum sensitivity. On the other hand, CISPR 16 requires a minimum spacing of 6 dB between base noise and limit lines.

The analyzer settings should be modified to Att = 20 dB and PreAmp = OFF. This would rise the noise floor approximately 40 dB, but still leave 40 dB of dynamic range below the limit lines. The sensitivity is still more than sufficient and the risk of creating non-linear distortions or ADC saturation is significantly reduced.

Whenever choosing the analyzer settings, first have a look at the limit lines and then decide on the amplitude settings.

Most standards have the limits for conducted noise settings sufficiently high, to operate with at least 20 dB attenuation and without pre-amplifier.

Exceptions are automotive standards such as CISPR 25 Class 5 or generic car manufacturer standards, which require higher sensitivity:

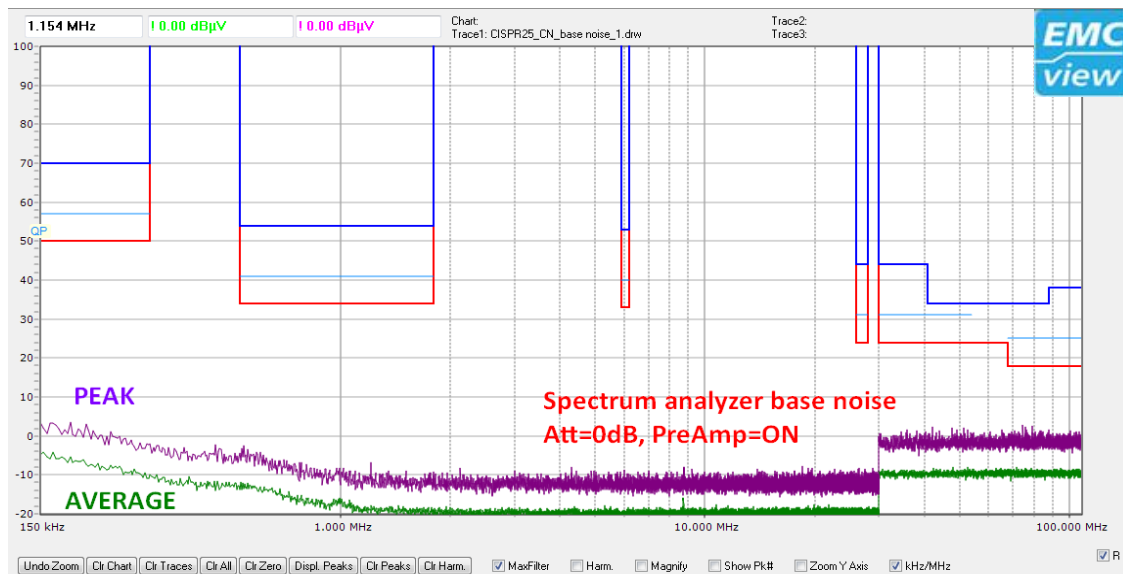

In case of nonlinear distortion issues, the pre-amplifier could be turned off at the most, in order to leave sufficient dynamic range for the frequency range above 60 MHz.

How to correctly use spectrum analyzers for EMC pre-compliance tests

6.2 Conducted noise testing with RF current probes

When performing conducted noise measurements with RF current monitoring probes, the trans-impedance value in dBΩ subtracted from the measurement value in dBμV gives the RF current in dBμA.

$$dB\mu A = dB\mu V - dB(\Omega)$$

In case of an RF current monitoring probe with a trans-impedance of 0 dBΩ, the readings at the probe output in dBμV are equivalent to the RF current passing the probe cross section in dBμA.

The screenshot below shows the limits for a CISPR 25 Class 5 Current Method measurement. Note that the limits are given in dBμA.

The displayed trace corresponds to settings for maximum analyzer sensitivity: Att = 0dB, PreAmp=ON

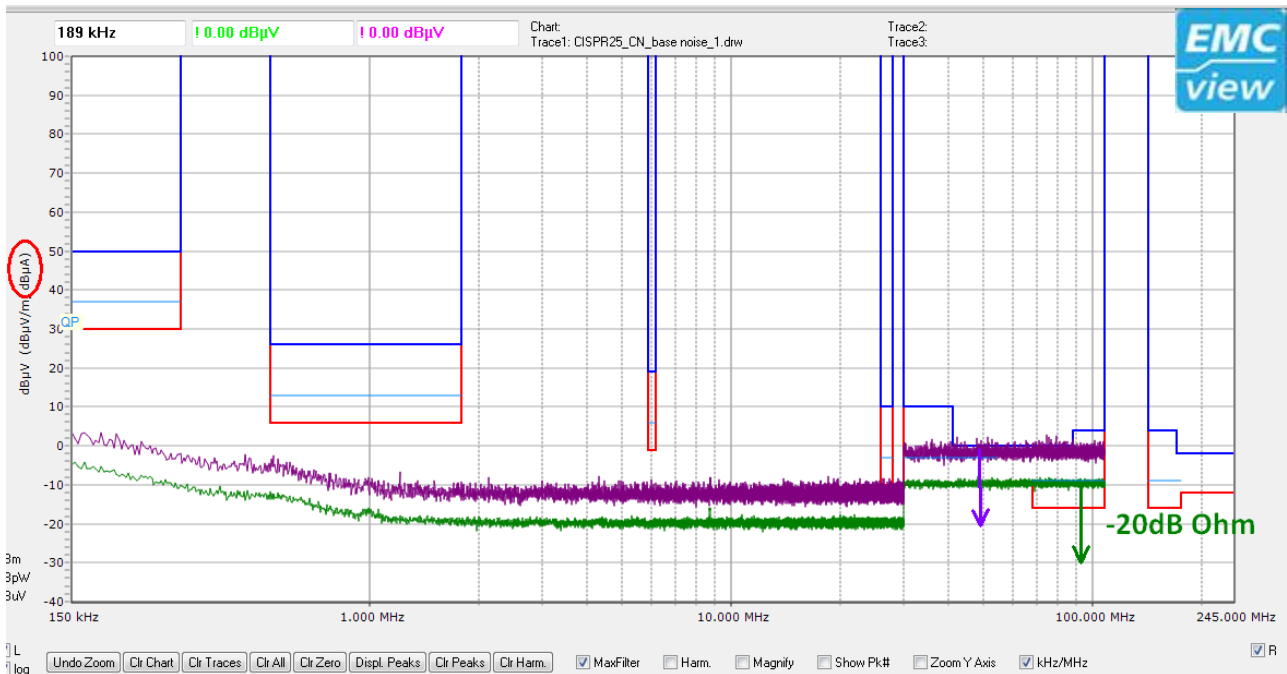

If an RF current probe with a trans-impedance of 0 dBΩ would be used for this measurement, the base noise would collide with the limits above 25 MHz, even at maximum sensitivity settings.

In order to carry out a useful measurement, an RF current monitoring probe with a trans-impedance of at least 15 dBΩ to 20 dBΩ is required.

The screenshot below shows the base noise of a CISPR 25 class 5 Current Method measurement, using a TBCP2-500 RF current monitoring probe from Tekbox with the spectrum analyzer internal attenuation set to 0 dB and the pre-amplifier turned on. This setup gives sufficient dynamic range to carry out a useful measurement:

How to correctly use spectrum analyzers for EMC pre-compliance tests

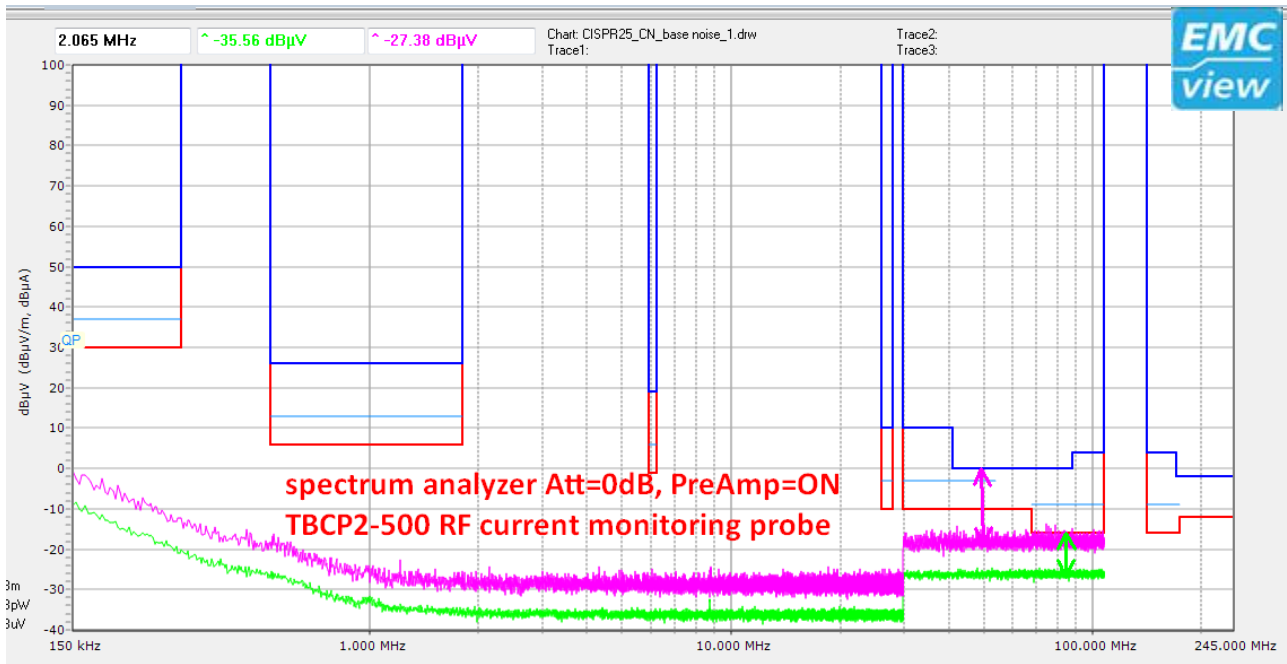

6.3 Radiated noise testing with TEM-cells

Transverse-Electromagnetic Cells (TEM cells) are a stripline device for radiated emissions and immunity testing of electronic devices.

Radiated noise testing in TEM cells can be started with sensitivity set to maximum. There is typically no big risk of overdriving or damaging the analyzer. In case of high amplitude emissions, the settings can be adjusted accordingly.

The screenshot below shows the limits for CISPR 25 Class 5 TEM Cell versus spectrum analyzer base noise with the spectrum analyzer internal attenuation set to 0 dB and the pre-amplifier turned on.

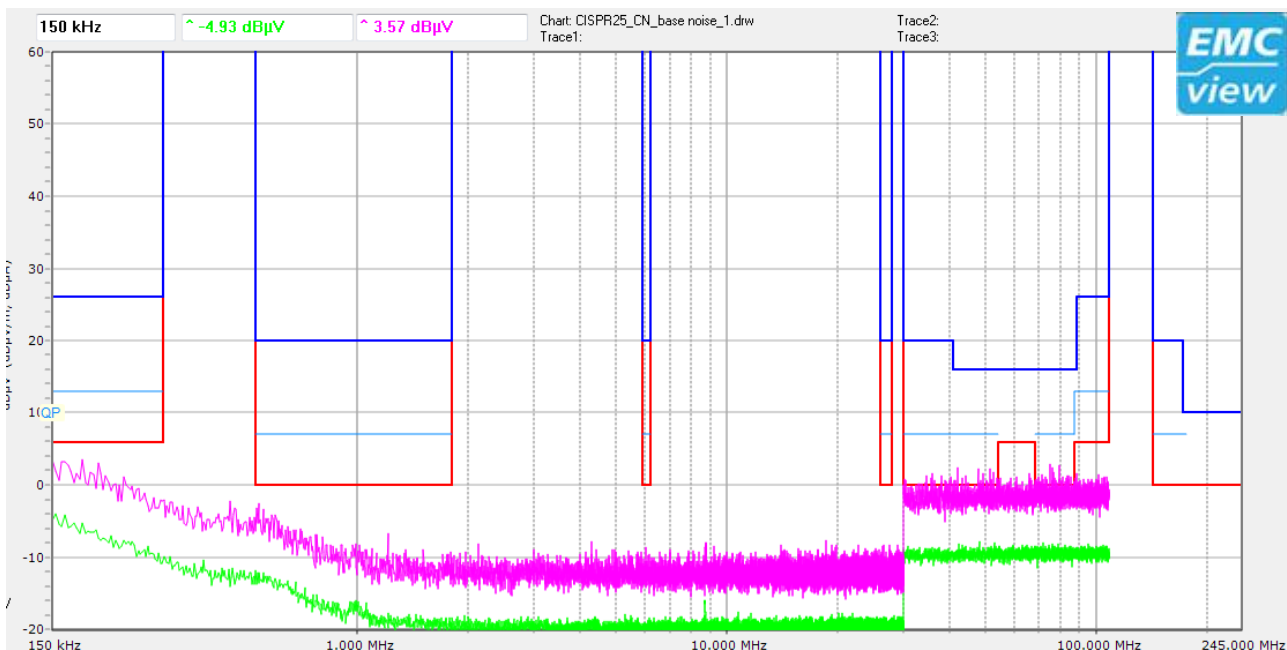

How to correctly use spectrum analyzers for EMC pre-compliance tests

6.4 Radiated noise testing with antennas

Radiated noise limits are given in dB μ V/m in most cases. In order to convert the measurement result from voltage at 50 Ohm [dB μ V] to field strength [dB μ V/m], it is necessary to know the antenna characteristics versus frequency. Measurement antennas always come with an antenna factor table. The antenna factor needs to be added to the voltage displayed at the analyzer in order to obtain the field strength:

$$\text{dB}\mu\text{V/m} = \text{dB}\mu\text{V} + \text{AF}$$

Consequently, the antenna factor also adds to the base noise and reduces the dynamic range of the measurement.

EMC measurement antennas have typically a large bandwidth. The larger the bandwidth, the lower the gain and the higher the antenna factor.

The screenshot below shows CISPR32 Class A radiated emission limits in dB μ V/m for a measurement distance of 3m.

The dark green graph shows the spectrum analyzer base noise in dB μ V with the internal attenuation set to 0 dB and the pre-amplifier turned on.

The light blue graph shows the base noise in dB μ V/m when used together with the 30 MHz – 1GHz TBMA1 biconical antenna from Tekbox.

The dark blue graph shows the base noise in dB μ V/m when used together with the 30 MHz – 300MHz TBMA2 biconical antenna of Tekbox.

The light green graph shows the base noise in dB μ V/m when used together with the 250 MHz – 1.3 GHz TBMA3 logarithmic periodic antenna of Tekbox.

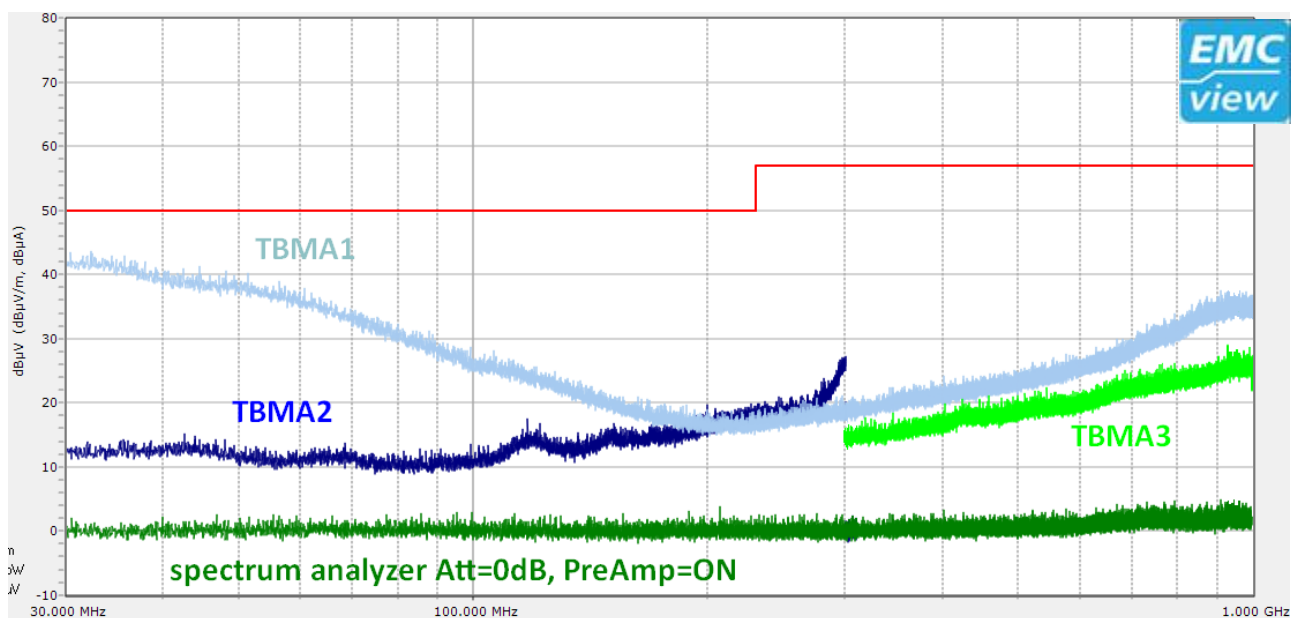

Based on the above analysis of the base noise, there seems to be sufficient dynamic range for carrying out CISPR 32 Class A radiated noise measurements using the Siglent SSA3021X spectrum analyzer and any of the mentioned EMC measurement antennas from Tekbox.

However, the above graphs would only be realistic when carrying out the measurement in a shielded anechoic chamber. In reality, EMC pre-compliance radiated emission tests are often carried out in a non-shielded environment such as a development laboratory or an industrial site.

How to correctly use spectrum analyzers for EMC pre-compliance tests

The following screenshot shows the output of the TBMA1 measurement antenna, in an industrial environment.

In the frequency range from 30 MHz to 100 MHz, the ambient noise already exceeds the CISPR 32 Class A radiated limits and severely handicaps the radiated noise measurement of any EUT. Even at higher frequencies, it will become very difficult to differentiate between ambient noise and noise originating from the EUT:

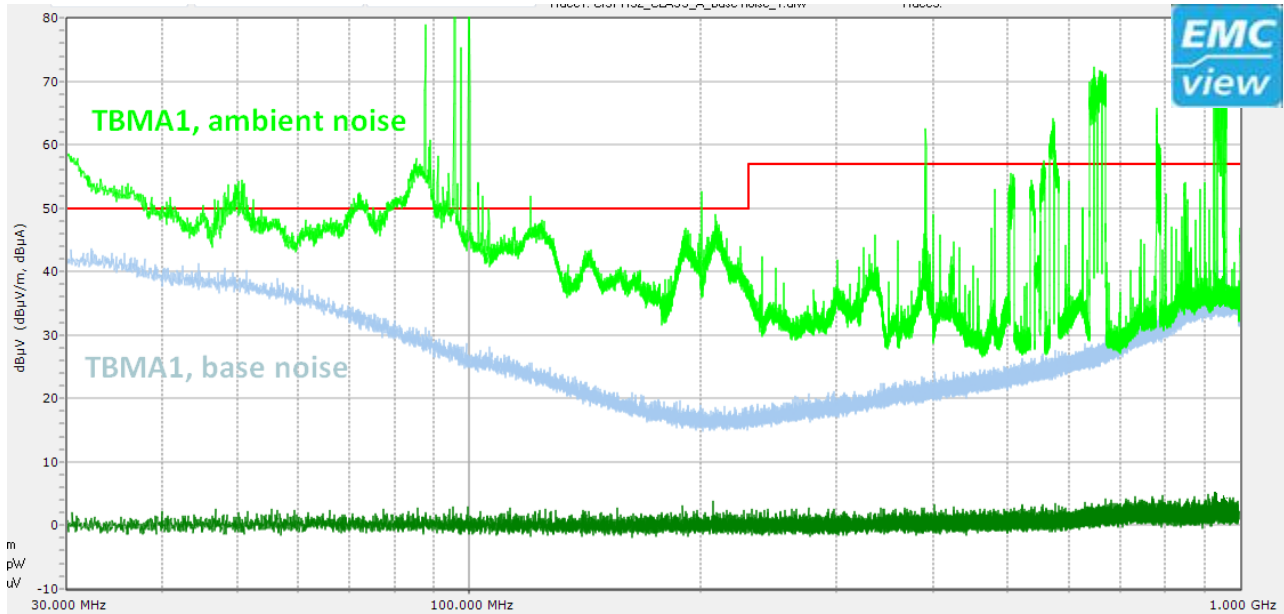

However, there are a few solutions to combat the ambient noise issue. Try to find a location with less ambient noise. A flat roof or a test site in a field are often less noisy than an industrial site. When measuring inside a lab, turn off all equipment nearby to eliminate noise from switched mode power supplies.

Move the antenna closer to the EUT. Reducing the measurement distance from 3m to 1m is equivalent to approximately 10 dB less free space loss or lifting the limits 10 dB higher. However, consider that the antenna may move into the near field zone at lower frequencies.

Use a lower bandwidth measurement antenna with lower antenna factors.

Measure your EUT inside a TEM cell to get a plot of the critical emissions. Knowing the frequencies of critical spurious, repeat the antenna measurement, but reduce span and RBW. Zoom in on critical frequencies, so to say.

Carry out the measurement at night, when there is typically less ambient noise.

7 Input protection

Whenever working with spectrum analyzers, be aware that excessive input power, voltage transients or ESD can destroy the RF-frontend. Spectrum analyzers typically have a maximum CW input rating in the range of +20 dBm to +30 dBm. Unlike oscilloscopes, spectrum analyzer inputs are not protected or only vaguely protected. A simplified RF frontend looks as below:

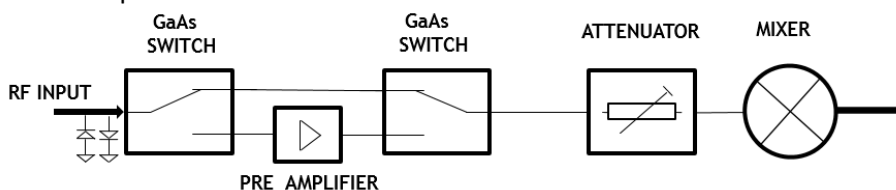

How to correctly use spectrum analyzers for EMC pre-compliance tests

The diodes at the input typically serve as ESD protection diodes. In order to fully protect the input with a limiter, shunt diodes would need to be combined with a series resistor to limit forward current in case of excessive input signal. Consequently, a classic current limiting resistor solution cannot be implemented, as it would increase the input impedance of the analyzer.

A limiter could be implemented by combining it with an attenuator, however this would degrade the sensitivity of the analyzer and limit its use.

The first weak link of the input chain is the RF switch. Typical EMI spectrum analyzers use integrated GaAs switches. GaAs switches are inherently weak at low frequencies. Many GaAs switches are not even specified with respect to maximum input power at low frequencies, down to 9 kHz.

Below is an example of an “honest” data sheet of a typical GaAs switch:

HMC221B

ABSOLUTE MAXIMUM RATINGS

Table 2.

Parameter	Rating
Control Voltage Range (A and B)	-0.2 V dc to 12 V dc
RF Input Power Level (CW Peak, $V_{CTL} = 0V/5V$)	0.36 W
10 kHz to 10 MHz	8 dBm
10 MHz to 20 MHz	10 dBm
20 MHz to 30 MHz	11 dBm
30 MHz to 250 MHz	14 dBm
250 MHz to 3.0 GHz	31 dBm
Hot Switching RF Input Power Level (CW Peak, $V_{CTL} = 0V/5V$)	
10 kHz to 250 MHz	6 dBm
250 MHz to 3.0 GHz	20 dBm

The maximum RF input power ratings versus frequency clearly show the degradation at low frequencies.

Residual 50 Hz voltage at the RF output of LISN:

The picture below shows the basic circuit diagram of an AC LISN:

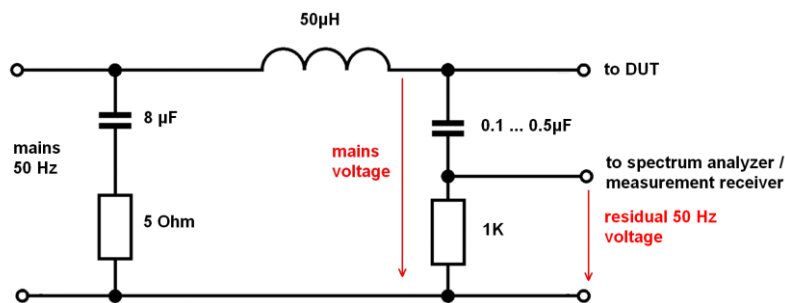

The full AC mains voltage is present at the DUT terminals of the LISN. The RF coupling capacitor and the 1K resistor form a voltage divider, which determines the amplitude of the 50 Hz voltage at the RF connector.

Considering a 0.1 μ F capacitor, which has an impedance of 32K at 50 Hz. Together with the 1K resistor, the resulting 50 Hz voltage at the RF terminal of the LISN is approximately 6.6V in the absence of any load. Assuming a 50 Ohm load in parallel to the 1K resistor, the residual 50 Hz voltage would become negligible.

Some LISN may need to use a higher value, in order to meet the impedance specifications at lower frequencies. Assuming a 0.5 μ F capacitor, the residual 50 Hz voltage at the RF terminal of the LISN would be as high as 31V. This still would become reduced to a negligible value, if a 50 Ohm load in parallel to the 1K resistor is present.

How to correctly use spectrum analyzers for EMC pre-compliance tests

However, it is unlikely that a low cost analyzer has an input impedance of 50 Ohm at 50 Hz. Typically the input impedance is not specified for frequencies below 9 kHz. Furthermore, as already mentioned, low cost analyzers use GaAs switches at the RF input, which are inherently vulnerable at low frequencies.

Consequently, placing a 9 kHz high pass filters, or 150 kHz high pass filters at the RF input of a spectrum analyzer or measurement receiver will offer good protection against residual 50 Hz voltage. Due to its very low insertion loss in the pass band, it will not reduce the dynamic range of the measurement.

Sub-harmonics of switched mode regulators:

When carrying out conducted noise tests of switched-mode power supplies, the highest spurious levels occur at relatively low frequencies. Sub-harmonics are even more critical. These are typically at frequencies significantly below 100 kHz and unless they produce audible noise due to magnetostriction of the power inductors, they often go completely unnoticed, as most tests start at 9 kHz or 150 kHz. You may carry out a conducted noise test and wonder, why the analyzer beeps and displays an ADC overflow warning, despite all spurious being well below limits. What drives the attenuator into saturation may be a very high amplitude sub-harmonic at e.g. 6 kHz.

In case that you notice that your signals are in the range of 20 dB lower than what they actually are, disaster already happened. The first GaAs switch is already damaged. In most cases, it fails with a short on the RF path and protects the following components, but in extreme cases, the damage will reach as far as the first mixer.

In order to prevent such things happen, you always should start investigating any new EUT using external attenuators, high pass filters or a combined attenuator/filter/limiter. With an external 20 dB attenuator or limiter attached to the analyzer input, have a look at the spectrum at very low frequencies and ensure that there are no signals with critically high amplitude.

Alternatively, you can first connect an oscilloscope to the LISN RF output and check the EUT emissions in the time domain. In order to establish the same impedance level as with a connected spectrum analyzer, terminate the oscilloscope input with a 50 Ohm feed through or switch the input to 50 Ohm, if the scope offers this feature.

Here are some guidelines when performing conducted emission measurements with a LISN:

- 1) Leave the RF output of the LISN unconnected
- 2) Connect the EUT to the LISN
- 3) Connect the LISN to the isolation transformer
- 4) Power on the EUT
- 5) Check the RF output of the LISN using a scope and / or the analyzer with an external 20 dB attenuator and 9kHz (150kHz) low pass filter or combined attenuator/filter/limiter
- 6) Connect the RF cable from LISN output to the spectrum analyzer input
- 7) Carry out the conducted noise scan
- 8) Disconnect the RF cable
- 9) Power off the EUT

How to correctly use spectrum analyzers for EMC pre-compliance tests

NOTE: The purpose of having the analyzer disconnected during power cycling (ON/OFF) the EUT is to avoid voltage transients due to back EMF, especially of highly inductive loads such as motors or switched-mode power supplies. These signals can easily be large and fast enough to cause permanent damage to the sensitive RF front end of the analyzer.

In cases where the EUT produces sub harmonics, place a 9 kHz or 150 kHz high pass filter at the RF input of the spectrum analyzer. Alternatively, the Tekbox TBFL1 transient limiter not only contains a combined attenuator/limiter, but also a 9 kHz high pass filter.

8 History

Version	Date	Author	Changes
V 1.0	22.11.2021	Michael Mayerhofer (Tekbox)	Creation of the document
V 1.1	28.11.2021	Michael Mayerhofer (Tekbox)	Updated chapter 5
V 1.2	13.1.2022	Jason Chonko (Siglent)	Grammar, typos, and re-arranged sections for clarity
V 1.3	9.4.2022	Michael Mayerhofer	Updated chapter 9