



Modulated Wideband Power Amplifier

ar Benelux B.V.
Frankrijklaan 7, ITC Boskoop
2391 PX HAZERSWOEDE DORP
The Netherlands
tel: +31 (0) 172 423 000
Web : www.arbenelux.com
email: arbeneluxinfo@arworld.us

1 Introduction

Tekbox provides a complete solution for affordable pre-compliance conducted immunity testing: Coupling Decoupling Networks along with suitable calibration adapters and 150 Ohm transitions; BCI probes, suitable modulated wideband power amplifiers and EMCview PRO software. A third-party spectrum analyzer with tracking generator serves as signal source.

The TBMDA-BCI25 modulated amplifier provides the necessary bandwidth and modulation for conducted immunity testing using BCI probes per ISO 11452-4 in the frequency range from 1 MHz to 400 MHz. It is designed to be driven by signal generators or by tracking generators of spectrum analyzers. With a 1 dB compression point of up to 30 W in the frequency range 1 MHz to 400 MHz it can generate test levels up to 400mA. A built in AM / PM - modulator enables use of tracking generators as signal source. The TBMDA-BCI25 has sufficient gain to achieve maximum output power with 0 dBm provided by a spectrum analyzer tracking generator.

Besides 1 kHz, 80% AM, the TBMDA-BCI25 provides built in modulation capability to generate 1 kHz, 50% duty cycle PM signals. In PM mode, the TBMDA-BCI25 can also generate a 217 Hz Signal with 12.5% duty cycle in order to simulate mobile phone TDMA noise.



Picture 1 – TBMDA-BCI25 modulated wideband driver amplifier, front view



Modulated Wideband Power Amplifier

Picture 2 – TBMDA-BCI25 modulated wideband driver amplifier, rear view

Application:

General-purpose wideband RF power amplifier

Wideband RF power amplifier for conducted immunity testing driving BCI-probes

Wideband RF power amplifier for radiated immunity testing, driving near field probes

Wideband RF power amplifier for radiated immunity testing, driving TEM Cells

Features:

CW amplifier (modulation off)

1 kHz, 80% AM modulation

1 kHz, 50% duty cycle pulse modulation

217 Hz, 12.5% duty cycle pulse modulation

Dimensions:

32 cm x 28 cm x 13 cm, 5.7 kg

2 Electrical Specifications

Technical Data:

Input / Output: 50 Ohm, N female

Supply Voltage range: 110 V...240 V

Supply power consumption: 108 W @ 220V

Operating temperature range: -20°C to 50°C

Frequency range: 1 MHz – 400 MHz

Small signal gain: 47 dB typ.

Gain flatness 1 MHz – 400 MHz / Pin = -3 dBm: 1.5 dB typ.

Saturated output power @ 1 MHz / Pin = 0 dBm: 45.1 dBm (32.2 W) typ.

Saturated output power @ 10 MHz / Pin = 0 dBm: 45.2 dBm (33 W) typ.

Saturated output power @ 50 MHz / Pin = 0 dBm: 45.9 dBm (38.6 W) typ.

Saturated output power @ 100 MHz / Pin = 0 dBm: 45.7 dBm (37.5 W) typ.

Saturated output power @ 150 MHz / Pin = 0 dBm: 46.2 dBm (41.2 W) typ.

Saturated output power @ 200 MHz / Pin = 0 dBm: 45.6 dBm (36.1 W) typ.

Saturated output power @ 250 MHz / Pin = 0 dBm: 46.3 dBm (42.5 W) typ.

Saturated output power @ 300 MHz / Pin = 0 dBm: 46 dBm (39.7 W) typ.

Saturated output power @ 350 MHz / Pin = 0 dBm: 45.8 dBm (37.8 W) typ.

Saturated output power @ 400 MHz / Pin = 0 dBm: 45 dBm (31.6 W) typ.

Modulated Wideband Power Amplifier

1dB output compression point @ 1 MHz: 44.1 dBm typ. (Pin: -4 dBm)
1dB output compression point @ 10 MHz: 44.6 dBm typ. (Pin: -3 dBm)
1dB output compression point @ 50 MHz: 45.3 dBm typ. (Pin: -2 dBm)
1dB output compression point @ 100 MHz: 45.2 dBm typ. (Pin: -1 dBm)
1dB output compression point @ 150 MHz: 45.2 dBm typ. (Pin: -2 dBm)
1dB output compression point @ 200 MHz: 45.2 dBm typ. (Pin: -1 dBm)
1dB output compression point @ 250 MHz: 45.6 dBm typ. (Pin: -2 dBm)
1dB output compression point @ 300 MHz: 45.1 dBm typ. (Pin: -2 dBm)
1dB output compression point @ 350 MHz: 44.8 dBm typ. (Pin: -2 dBm)
1dB output compression point @ 400 MHz: 43.6 dBm typ. (Pin: -4 dBm)

2nd harmonic, 100 MHz, Pout = 45.7 dBm: < - 23 dBc typ.

2nd harmonic, 100 MHz, Pout = 40 dBm: < - 29 dBc typ.

3rd harmonic, 100 MHz, Pout = 45.7 dBm: < - 12 dBc typ.

3rd harmonic, 100 MHz, Pout = 40 dBm: < - 19 dBc typ.

Total harmonic distortion:

8.6% @100MHz, Pout = 37 dBm typ.

12.1% @100 MHz, Pout = 40 dBm typ.

17.6% @100 MHz, Pout = 43 dBm typ.

25% @100 MHz, Pout = 45.7 dBm typ.

Third order output intercept point: 49 dBm, @100 MHz, $\Delta f = 2\text{MHz}$, typ.

Internal modulation frequency AM: 1 kHz $\pm 20\%$

Internal modulation frequencies PM: 1 kHz $\pm 20\%$, 217 Hz $\pm 20\%$

Duty cycle, PM: 50% $\pm 10\%$ @ 1 kHz; 12.5% $\pm 20\%$ @ 217 Hz

Maximum ratings:

Maximum input power: +0 dBm

The output of the TBMDA-BCI25 is quite tolerant to output mismatch, however open or shorted load is not recommended, as it potentially can cause damage to the output transistor. When driving near field probes, current probes or any load of unknown impedance, it is highly recommended to insert a $\geq 3\text{dB}$ attenuator at the output of the amplifier in order to protect the output stage.

Modulated Wideband Power Amplifier

Gain flatness:

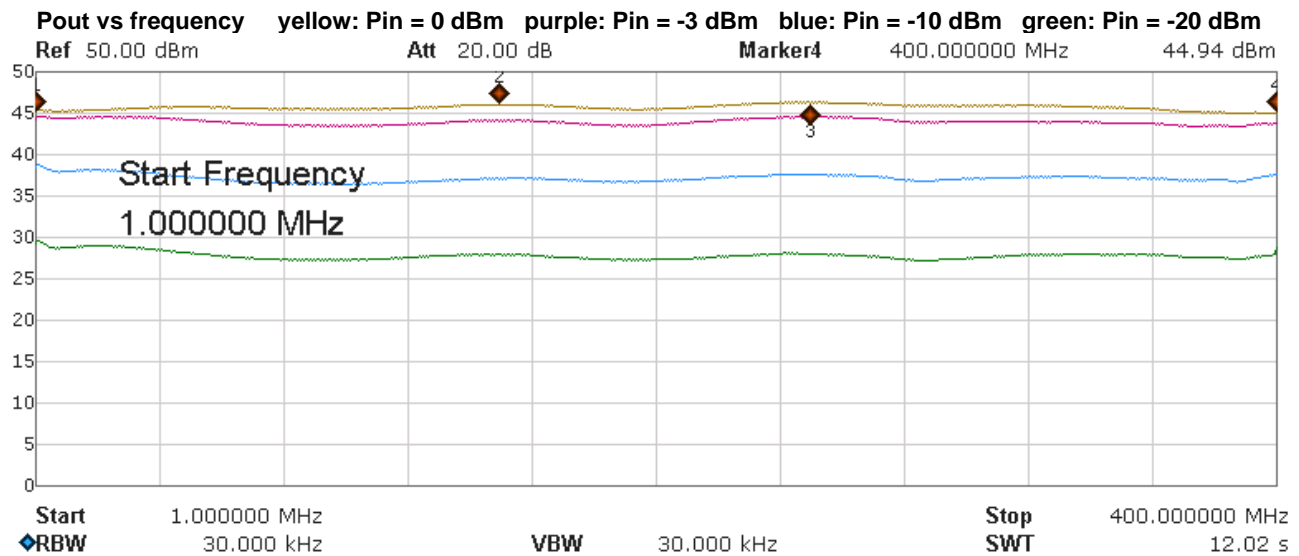

Marker Table

Marker	Trace	Readout	X Axis	Ampt
Marker1	A	Frequency	1.000000 MHz	44.99 dBm
Marker2	A	Frequency	150.000000 MHz	45.92 dBm
Marker3	A	Frequency	250.000000 MHz	46.23 dBm
Marker4	A	Frequency	400.000000 MHz	44.94 dBm

Small Signal Performance (@ Pin = - 10 dBm):

Frequency [MHz]	1	10	50	100	150	200	250	300	350	400
Output power [dBm]	38.66	38.1	37.56	36.69	37.39	37.1	37.91	37.45	37.55	38.1
Gain [dB]	48.66	48.1	47.56	46.69	47.39	47.1	47.91	47.45	47.55	48.1

Table 1 – TBMDA-BCI25 small signal gain, typ.

1 dB compression point:

Frequency [MHz]	1	10	50	100	150	200	250	300	350	400
Output power [dBm]	44.11	44.59	45.32	45.15	45.24	45.2	45.63	45.07	44.82	43.6
Input power [dBm]	-4	-3	-2	-1	-2	-1	-2	-2	-2	-4

Table 2 – TBMDA-BCI25, 1 dB compression point versus frequency, typ.

Saturation (@ Pin = 0 dBm):

Frequency [MHz]	1	10	50	100	150	200	250	300	350	400
Output power [dBm]	44.99	45.19	45.87	45.74	45.92	45.57	46.23	45.99	45.78	44.94
Gain [dB]	44.99	45.19	45.87	45.74	45.92	45.57	46.23	45.99	45.78	44.94

Table 3 – TBMDA-BCI25, Saturation versus frequency, typ.

Modulated Wideband Power Amplifier

Modulation:

Zero span, 10 ms sweep time, peak detector

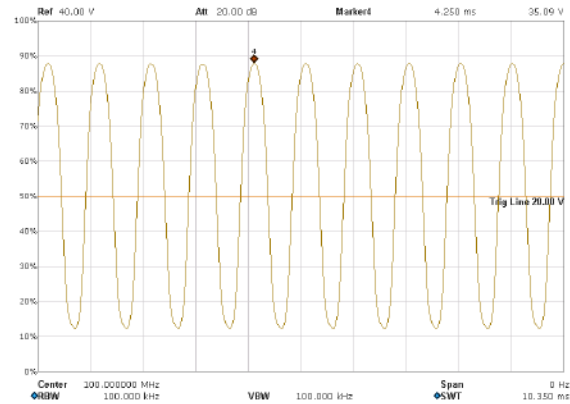

Figure 1 – 1 kHz, 80 % AM, envelope, 100 MHz, Pout = 44 dBm peak;

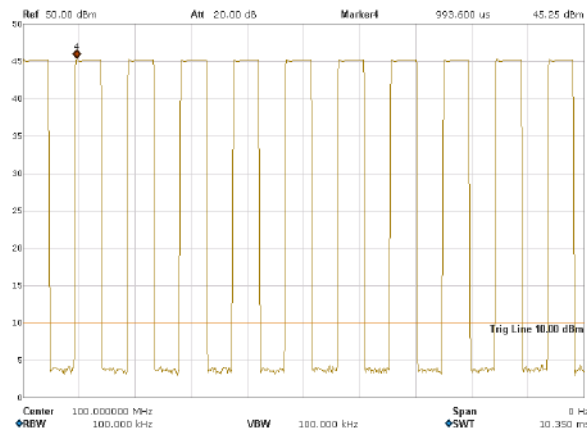

Figure 2 – 1 kHz, 50 % PM envelope, 100 MHz, Pout = 45 dBm peak

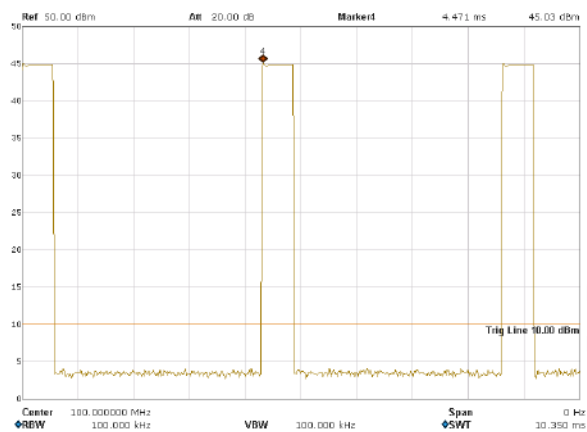

Figure 3 – 217 Hz, 12.5 % PM envelope, 100 MHz, Pout = 45 dBm peak

Modulated Wideband Power Amplifier

3 Applications - radiated immunity

Immunity testing using a TEM cell

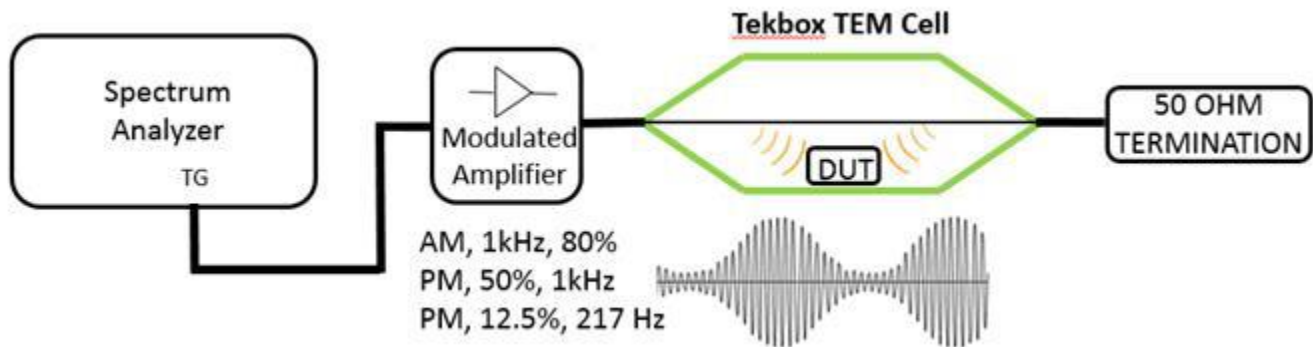

Figure 4 – immunity testing set up

Immunity testing using near field probes

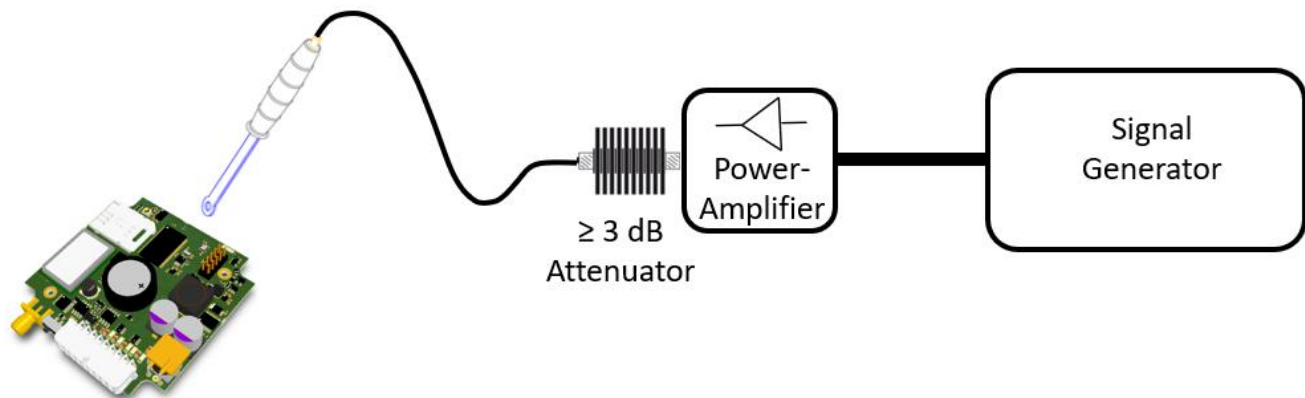

Figure 5 – immunity testing set up to locate susceptible areas on PCBAs

Radiated immunity EMC pre-compliance is typically a 2-step procedure. First, a TEM cell is used to investigate for immunity issues of the DUT. In case of any failure, near-field probes will be used to locate the sensitive circuitry on the PCBA.

Modulated Wideband Power Amplifier

TEM Cell field strength

A typical pre-compliance set up for immunity testing is typically not equipped with an E-field probe to measure the real field strength inside the TEM cell. However, the field strength can be calculated with sufficient accuracy for EMC pre-compliance set-ups.

The E-field (V/m) between septum and lower (upper) wall of a TEM cell is $E = V/d$ where V is the RMS voltage of the applied signal and d is the distance between septum and lower (upper) wall. This is based on the simplified assumption that the E field would be perfectly homogenous/evenly distributed. A more practical formula is $E = V*Cor/d$ where Cor is a correction factor for the average field strength over the volume of the DUT derived from the analysis of the field distribution over the cross section of the cell.

Assuming the DUT is placed in the center of the cell and in the middle between bottom wall and septum, we can use the simplified formula with sufficient accuracy.

$$TBTC0: d = 2.8 \text{ cm} \rightarrow E_{[V/m]} = (\sqrt{P*50\Omega}) * 35.7$$

$$TBTC1: d = 5 \text{ cm} \rightarrow E_{[V/m]} = (\sqrt{P*50\Omega}) * 20$$

$$TBTC2: d = 10 \text{ cm} \rightarrow E_{[V/m]} = (\sqrt{P*50\Omega}) * 10$$

$$TBTC3: d = 15 \text{ cm} \rightarrow E_{[V/m]} = (\sqrt{P*50\Omega}) * 6.66$$

The power P in the formulas above has to be entered in [Watt]

$$P_{[W]} = 0.001 * (10^{(P_{[dBm]}/10)})$$

Frequency [MHz]	Input power [dBm]	Output power [dBm]	Field strength TBTC0 [V/m]	Field strength TBTC1 [V/m]	Field strength TBTC2 [V/m]	Field strength TBTC3 [V/m]
1	-3	44.54	1346.3	754.2	377.1	251.2
10	-3	44.59	1354.1	758.6	379.3	252.6
50	-3	44.55	1347.9	755.1	377.6	251.5
100	-3	43.96	1259.4	705.5	352.8	234.9
150	-3	44.5	1340.1	750.8	375.4	250
200	-3	44.06	1274	713.7	356.8	237.7
250	-3	44.97	1414.7	792.5	396.3	263.9
300	-3	44.37	1320.2	739.6	369.8	246.3
350	-3	44.1	1279.8	717	358.5	238.8
400	-3	44.14	1285.7	720.3	360.2	239.9

Table 4 – calculated field strength for the TBMDA-BCI25 driving Tekbox TEM cells

The above output power is the RMS output power in case of a CW signal. Note that in case of 80% AM modulation, the RMS power of the modulated signal will be 5.1 dB lower than the RMS power of the CW signal.

Modulated Wideband Power Amplifier

4 Applications - conducted immunity, using BCI probes

ISO 11452-4 BCI immunity test set up, substitution method

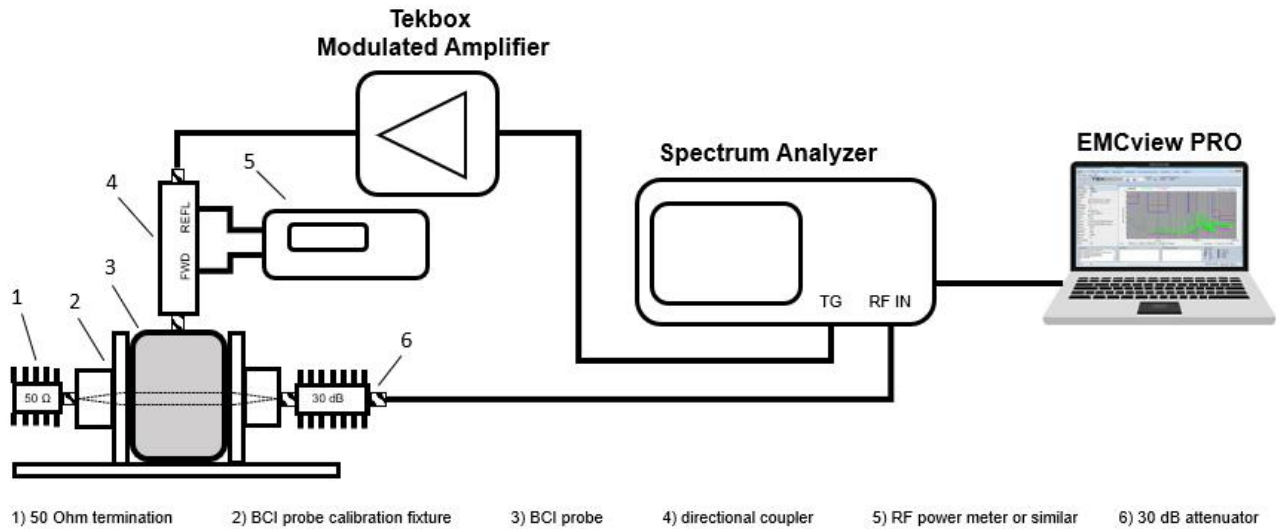

ISO 11452-4 BCI immunity test set up, closed loop method

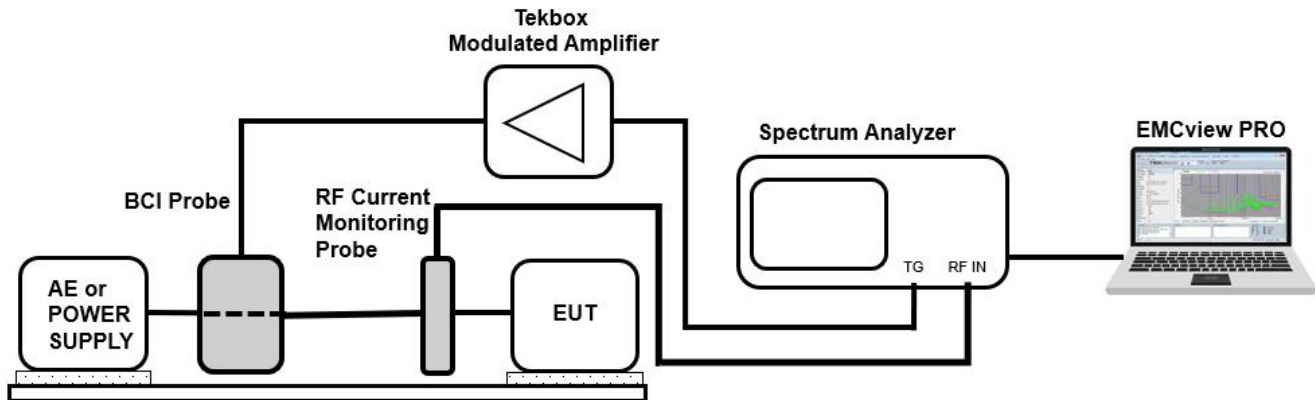

5 PC Software for immunity testing

Tekbox provides two software versions for EMC pre-compliance measurements

EMCview provides a feature to control the tracking generator output frequency and level and carry out sweeps with constant tracking generator level.

Modulated Wideband Power Amplifier

EMCview PRO provides a more sophisticated feature, which is able to carry out calibration sweeps for CDN and BCI based set ups. The resulting calibration file is used to set the tracking generator level during the immunity test sweep.

Tekbox EMCview currently supports Rigol, Siglent, Owon, R&S FPC and FPH series spectrum analyzers.

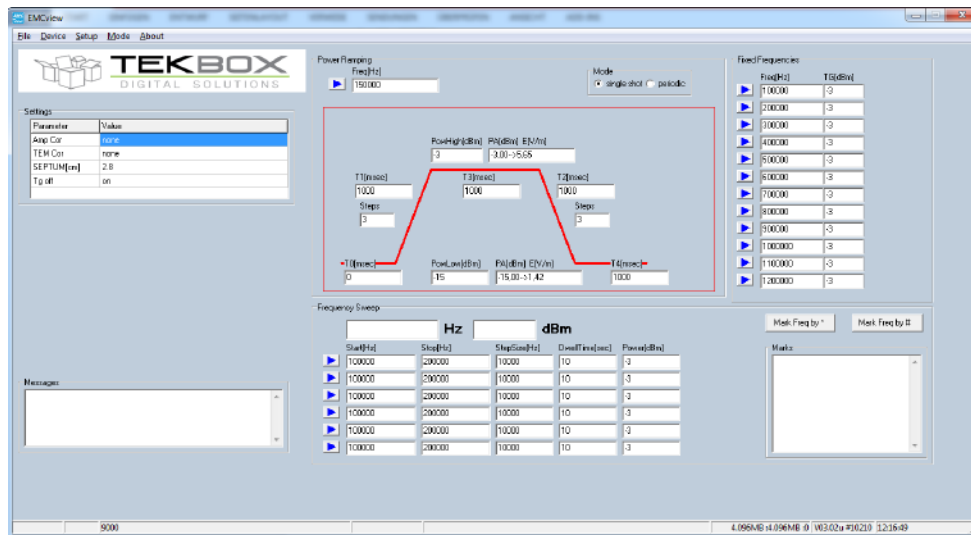

Figure 11 – screenshot of the tracking generator control feature of EMCview / EMCview Pro

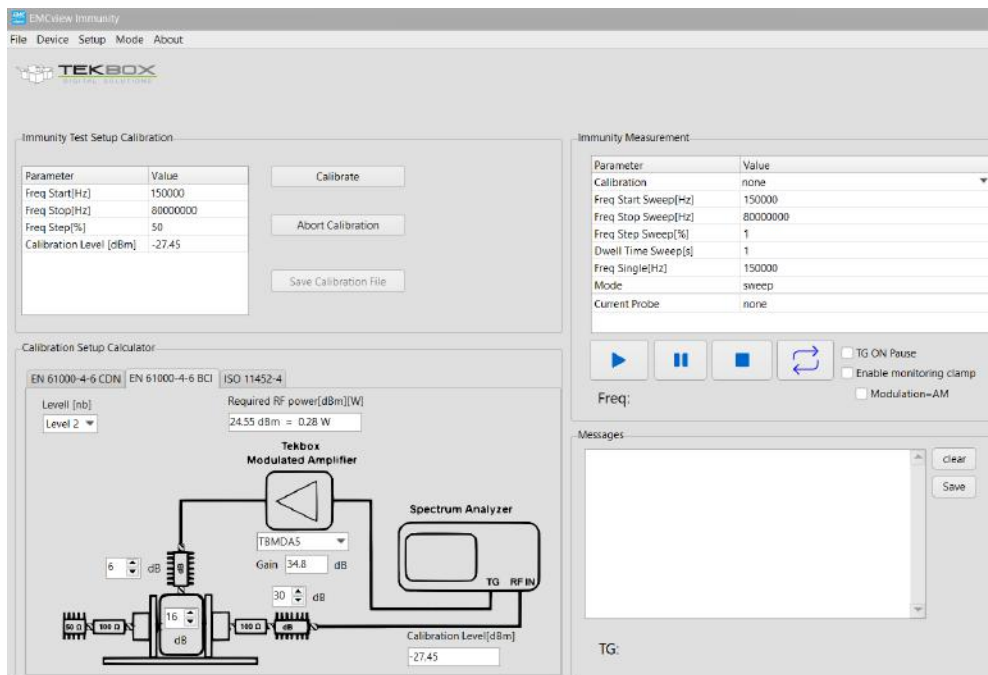

Figure 12 – screenshot of the EN61000-4-6 BCI immunity test feature of EMCview Pro

Modulated Wideband Power Amplifier

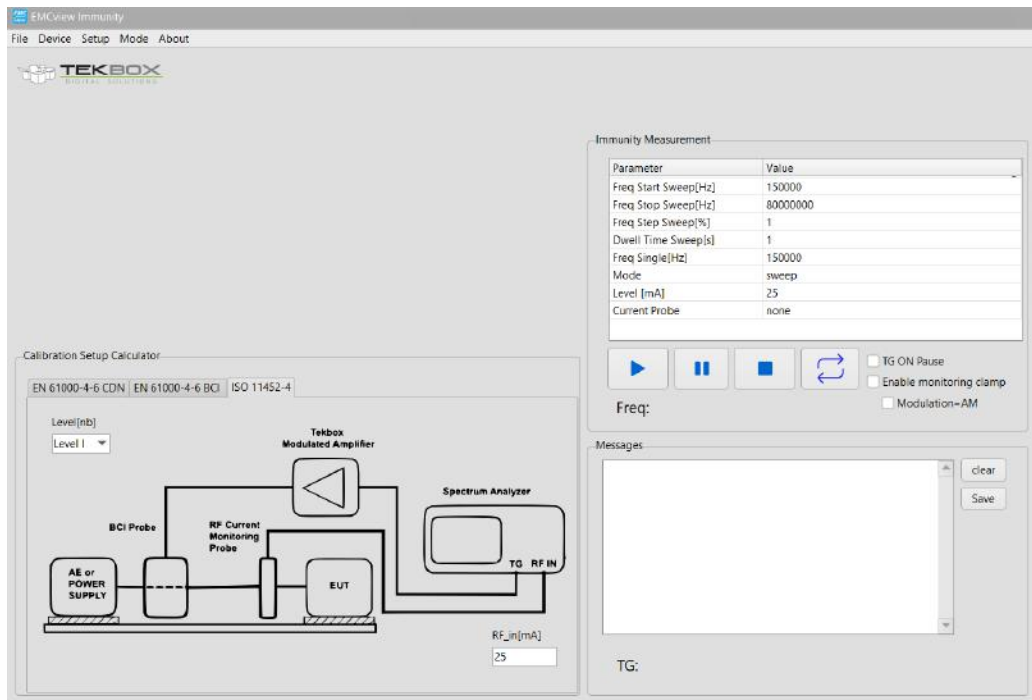

Figure 13 – screenshot of the ISO 11452-4 immunity test feature of EMCview Pro

WARNING:

Never connect the output of the TBMDA-BCI25 directly to the input of a spectrum analyzer. Check the maximum input ratings of the spectrum analyzer and protect it with an appropriate attenuator. Open or shorted load is not recommended, potentially can cause damage of the RF output stage. Use a ≥ 3 dB attenuator at the amplifier output, when driving loads with poor SWR.

Example:

Rigol DSA815 – maximum input power rating: +20dBm

Modulated Wideband Power Amplifier

6 Ordering Information

Part Number	Description
TBMDA-BCI25-EU	modulated power amplifier, 2 pcs 75cm N-male to N-male cables, 1 pc 6 dB attenuator, 1 pc 30dB / 50W attenuator with N-connectors, C13 Schuko power cord
TBMDA-BCI25-US	modulated power amplifier, 2 pcs 75cm N-male to N-male cables, 1 pc 6 dB attenuator, 1 pc 30dB / 50W attenuator with N-connectors, C13 US power cord
TBMDA-BCI25-UK	modulated power amplifier, 2 pcs 75cm N-male to N-male cables, 1 pc 6 dB attenuator, 1 pc 30dB / 50W attenuator with N-connectors, C13 English power cord
TBMDA-BCI25-AU	modulated power amplifier, 2 pcs 75cm N-male to N-male cables, 1 pc 6 dB attenuator, 1 pc 30dB / 50W attenuator with N-connectors, C13 Australian power cord

Table 5 – Ordering Information

7 History

Version	Date	Author	Changes
V1.0	19.05.2023	Mayerhofer	Creation of the document

Table 6 – History

www.tekbox.com

TekBox Digital Solutions Vietnam Pte. Ltd.

Factory 4, F5, Lot I-3B-1, Saigon Hi-Tech Park, Tan Phu Ward, District 9, Ho Chi Minh City, Vietnam

 Benelux B.V.
Frankrijklaan 7, ITC Boskoop
2391 PX HAZERSWOUDE DORP
The Netherlands
tel: +31 (0) 172 423 000
Web : www.arbenelux.com
email: arbeneluxinfo@arworld.us