

RF & EMC Product Catalog 2023



Table of Contents

Section	Page
Find it Fast	2
RF Solid State	11
Universal Series	27
Microwave	33
Solid State Pulsed	42
TWT	56
Systems	73
Antennas	86
Accessories	109
AR Companies	132
Service	147



For Sales, call: 215.723.8181
 email: sales@arworld.us
 For an Applications Engineer, call: 800.933.8181
 email: applications@arworld.us

Digital Catalog is available at <http://arworld.us/catalog>
 AR RF/Microwave Instrumentation is ISO Certified.



© Copyright 2023 AR.



Product Catalog | 2023

For Sales, call: 215.723.8181

For an Applications Engineer, call: 800.933.8181

arworld.us

2

Contents

[Find it Fast](#)

[RF Solid State](#)

[Universal Series](#)

[Microwave](#)

[Solid State Pulse](#)

[TWT](#)

[Systems](#)

[Antennas](#)

[Accessories](#)

[Contact](#)

[AR Companies](#)

Total Solutions

From complete testing systems to software, anechoic chambers and shielded rooms, AR is your one-stop for RF and EMC testing. Our testing solutions are built to last and come with the product quality and high-level support customers can expect from AR.

Throughout this catalog, you will find everything you need for RF and EMC testing. Use the table below to quickly find some of our more popular items.

#	Component	Page
1	Amplifiers	10
2	Antennas	86
3	Test Systems	76
4	Field Measuring Equipment	123
5	EMC Test Software	131
6	EMC & RF Test Accessories	109
7	Positioning Equipment	126

Find it Fast Table



Amplifiers

 Select a Model Number to view more details

Find it Fast Table

Frequency	Power (W)	Model Number	Category	Page
4 kHz - 400 MHz	100	100A400AM20	RF Solid State	13
10 kHz - 3 MHz	800	800A3B	RF Solid State	13
10 kHz - 100 MHz	150	150A100D	RF Solid State	14
10 kHz - 225 MHz	1200	1200A225B	RF Solid State	14
10 kHz - 225 MHz	2500	2500A225C	RF Solid State	15
10 kHz - 225 MHz	5000	5000A225C	RF Solid State	15
10 kHz - 225 MHz	10000	10000A225B	RF Solid State	16
10 kHz - 250 MHz	25	25A250B	RF Solid State	16
10 kHz - 250 MHz	50	50A250	RF Solid State	17
10 kHz - 250 MHz	125	125A250	RF Solid State	17
10 kHz - 250 MHz	500	500A250D	RF Solid State	18
10 kHz - 400 MHz	100	100A400A	RF Solid State	18
10 kHz - 400 MHz	175	175A400	RF Solid State	19
10 kHz - 400 MHz	250	250A400	RF Solid State	19
10 kHz - 400 MHz	350	350A400	RF Solid State	20
10 kHz - 400 MHz	600	600A400	RF Solid State	20
10 kHz - 400 MHz	1000	1000A400	RF Solid State	21
10 kHz - 1000 MHz	1	1U1000	Universal	29
10 kHz - 1000 MHz	2.5	2.5U1000	Universal	29
10 kHz - 1000 MHz	5	5U1000	Universal	30
10 kHz - 1000 MHz	10	10U1000	Universal	30

Frequency	Power (W)	Model Number	Category	Page
10 kHz - 1000 MHz	25	25U1000	Universal	31
10 kHz - 1000 MHz	50	50U1000	Universal	31
10 kHz - 1000 MHz	150	100U1000A	Universal	32
100 kHz - 1000 MHz	100	250U1000A	Universal	32
100 kHz - 1000 MHz	500	500U1000	Universal	33
50 - 1000 MHz	50	50W1000D	RF Solid State	21
80 - 1000 MHz	125	125W1000A	RF Solid State	22
80 - 1000 MHz	150	150W1000B	RF Solid State	22
80 - 1000 MHz	250	250W1000C	RF Solid State	23
80 - 1000 MHz	500	500W1000C	RF Solid State	23
80 - 1000 MHz	800	800W1000	RF Solid State	24
80 - 1000 MHz	1000	1000W1000H	RF Solid State	25
80 - 1000 MHz	2000	2000W1000E	RF Solid State	25
80 - 1000 MHz	3000	3000W1000B	RF Solid State	26
80 - 1000 MHz	4000	4000W1000B	RF Solid State	26
80 - 1000 MHz	6000	6000W1000	RF Solid State	27
80 - 1000 MHz	10000	10000W1000A	RF Solid State	27
0.7 - 6 GHz	15	15S1G6	Microwave	35
1 - 6 GHz	30	30S1G6C	Microwave	35
1 - 6 GHz	60	75S1G6C	Microwave	36



Amplifiers

 Select a Model Number to view more details

Find it Fast Table

Frequency	Power (W)	Model Number	Category	Page
1 - 6 GHz	125	125S1G6C	Microwave	36
1 - 6 GHz	250	250S1G6C	Microwave	37
1 - 6 GHz	500	500S1G6C	Microwave	37
1 - 6 GHz	750	750S1G6C	Microwave	38
1 - 6 GHz	1000	1000S1G6C	Microwave	38
0.8 - 2.5 GHz	1000	1000SP0z8G2z5	Pulse	45
0.8 - 2.5 GHz	2000	2000SP0z8G2z5	Pulse	45
0.8 - 2.5 GHz	4000	4000SP0z8G2z5	Pulse	46
0.8 - 2.5 GHz	8000	8000SP0z8G2z5	Pulse	46
1 - 2 GHz	1300	1300SP1G2	Pulse	47
1 - 2 GHz	2000	2000SP1G2	Pulse	47
1 - 2 GHz	4000	4000SP1G2	Pulse	48
1 - 2 GHz	8000	8000SP1G2	Pulse	48
1 - 2.5 GHz	2000	2000S1G2z8	Microwave	39
1 - 2.5 GHz	125	125S1G2z5	Microwave	39
1 - 2.5 GHz	250	250S1G2z5B	Microwave	40
1 - 2.5 GHz	500	500S1G2z5A	Microwave	40
1 - 2.5 GHz	1000	1000S1G2z5B	Microwave	41
6 - 18 GHz	20	20S6G18C	Microwave	41

Frequency	Power (W)	Model Number	Category	Page
6 - 18 GHz	40	40S6G18C	Microwave	42
6 - 18 GHz	75	75S6G18C	Microwave	42
1.2 - 1.4 GHz	1500	1500SP1z2G1z4	Pulse	49
1.2 - 1.4 GHz	4000	4000SP1z2G1z4	Pulse	49
1.2 - 1.4 GHz	8000	8000SP1z2G1z4	Pulse	48
1.2 - 1.4 GHz	80000	80000SP1z2G1z4	Pulse	52
2 - 4 GHz	1000	1000SP2G4	Pulse	52
2 - 4 GHz	2000	2000SP2G4	Pulse	53
2 - 4 GHz	4000	4000TP2G4	TWT	68
2 - 4 GHz	5000	5000SP2G4	Pulse	53
2 - 4 GHz	7000	7000SP2G4	Pulse	54
2 - 4 GHz	6900	6900TP2G4	TWT	69
2 - 4 GHz	10000	10000SP2G4	Pulse	54
2 - 4 GHz	15000	15000SP2G4	Pulse	55
2 - 4 GHz	20000	20000SP2G4	Pulse	55
2.5 - 7.5 GHz	300	300T2G8	TWT	59
2.5 - 7.5 GHz	500	500T2G8	TWT	59
2.5 - 7.5 GHz	1000	1000T2G8B	TWT	60



Amplifiers

Select a Model Number to view more details

Find it Fast Table

Frequency	Power (W)	Model Number	Category	Page
2.5 - 7.5 GHz	1700	1500T2G8A	TWT	60
2.5 - 7.5 GHz	2000	2000TP2G8B	TWT	69
2.7 - 3.1 GHz	4000	4000SP2z7G3z1	Pulse	56
2.7 - 3.1 GHz	8000	8000TP2z7G3z1	TWT	70
2.7 - 3.1 GHz	12000	12000SP2z7G3z1	Pulse	56
4 - 8 GHz	200	200T4G8	TWT	61
4 - 8 GHz	4000	4000TP4G8	TWT	70
4 - 8 GHz	7400	7400TP4G8	TWT	71
2.7 - 3.16 GHz	150/1000	150/1000SP1z2G3z1	Pulse	57
6 - 18 GHz	20	20S6G18A-L	Microwave	42
6 - 18 GHz	40	40S6G18A-L	Microwave	43
6 - 18 GHz	250	250T6G18	TWT	61
6 - 18 GHz	500	500T6G18	TWT	62
7.5 - 18 GHz	250	250T8G18	TWT	62
7.5 - 18 GHz	500	500T8G18	TWT	63
7.5 - 18 GHz	1000	1000T8G18B	TWT	63
7.5 - 18 GHz	1000	1000TP8G18	TWT	71
7.5 - 18 GHz	1500	1500T8G18	TWT	64

Frequency	Power (W)	Model Number	Category	Page
7.5 - 18 GHz	2000	2000TP8G18	TWT	72
8 - 12 GHz	4000	4000TP8G12	TWT	72
8 - 12 GHz	8300	8300TP8G12	TWT	73
8 - 12 GHz	20000	20000TP8G12	TWT	73
12 - 18 GHz	3000	3000TP12G18	TWT	74
12 - 18 GHz	5700	5700TP12G18	TWT	74
18 - 26.5 GHz	40	40T18G26A	TWT	64
18 - 26.5 GHz	130	130T18G26z5B	TWT	65
18 - 26.5 GHz	200	200T18G26z5A	TWT	65
26.5 - 40 GHz	40	40T26G40A	TWT	66
26.5 - 40 GHz	130	130T26z5G40B	TWT	66
26.5 - 40 GHz	200	200T26z5G40A	TWT	67
40 - 50 GHz	70	70T40G50	TWT	67
40 - 50 GHz	100	100T40G50	TWT	68



Systems

 Select a Model Number to view more details

Find it Fast Table

Description	Model Number	Page
IEC 61000-4-3 Predefined Systems		
3 V/m field strength with up to a 3 meter test distance from 80 MHz - 6 GHz	SSIEC3V3M	79
10 V/m field strength with up to a 2 meter test distance from 80 MHz - 6 GHz	SSIEC10V2M	79
10 V/m field strength with up to a 3 meter test distance from 80 MHz - 6 GHz	SSIEC10V3M	79
30 V/m field strength with up to a 2 meter test distance from 80 MHz - 6 GHz	SSIEC30V2M	79
30 V/m field strength with up to a 3 meter test distance from 80 MHz - 6 GHz	SSIEC30V3M	80
ISO 11451-2 Predefined Systems		
50 V/m field strength for full vehicle testing from 10 kHz - 18 GHz	SSISOV50V10K18G	80
50 V/m field strength for full vehicle testing from 20 MHz - 18 GHz	SSISOV50V20M18G	80
100 V/m field strength for full vehicle testing from 10 kHz - 18 GHz	SSISOV100V10K18G	80
100 V/m field strength for full vehicle testing from 20 MHz - 18 GHz	SSISOV100V20M18G	81
200 V/m field strength for full vehicle testing from 10 kHz - 18 GHz	SSISOV200V10K18G	81
200 V/m field strength for full vehicle testing from 30 MHz - 18 GHz	SSISOV200V30M18G	81
ISO 11452-2 Predefined Systems		
50 V/m field strength for vehicle component testing from 10 kHz - 18 GHz	SSISOC50V10K18G	81
50 V/m field strength for vehicle component testing from 80 MHz - 18 GHz	SSISOC50V80M18G	82
100 V/m field strength for vehicle component testing from 10 kHz - 18 GHz	SSISOC100V10K18G	82
100 V/m field strength for vehicle component testing from 80 MHz - 18 GHz	SSISOC100V80M18G	82
200 V/m field strength for vehicle component testing from 10 kHz - 18 GHz	SSISOC200V10K18G	82
200 V/m field strength for vehicle component testing from 80 MHz - 18 GHz	SSISOC200V80M18G	83

AR Predefined Test Systems Make Testing Easy

We have complete standard and custom test systems that perform entire RF & EMC tests with just the press of a few buttons. Everything you need – amplifiers, antennas, couplers, signal generators, system controllers, receivers, and more, along with the software to control it – all in one comprehensive system.

Your System, Your Way

AR is here for you at each step to ensure that the system design, integration, and support of your test system complies with your goals. AR has designed hundreds of EMC systems that vary in scope from a single, less complex rack of equipment for low field strength IEC 61000-4-3 testing to MIL-STD-461/464 test systems. Spanning from DC - 50 GHz, producing field strengths in excess of 4,000 V/m and everything in between AR Systems are in compliance with military, aviation, commercial and automotive test standards.

AR's Predefined Systems are designed to meet the minimum requirements of several of today's common EMC test standards. Depending on your needs, these systems can be used as is or tailored and customized to meet your specific requirements. Additionally, AR could also design a system that meets your needs from scratch.

AR Quality Backed by AR Protection

One of the added benefits of an AR test system is peace of mind. Every product in your AR test system is designed and built to the highest quality standards and backed by the most comprehensive warranty in the business and a global support network. When you have a question about any part of the system, you can call us. We've been here for over 50 years, and we'll continue to be here, serving your needs and engineering the products that meet tomorrow's challenges.



Systems

 Select a Model Number to view more details

Find it Fast Table

Description	Model Number	Page
MIL-STD-461 Predefined Systems		
10 V/m field strength for military testing applications from 10 kHz - 18 GHz	SSMIL10V10K18G	83
10 V/m field strength for military testing applications from 2 MHz - 18 GHz	SSMIL10V2M18G	83
10 V/m field strength for military testing applications from 2 MHz - 40 GHz	SSMIL10V2M40G	83
50 V/m field strength for military testing applications from 10 kHz - 18 GHz	SSMIL50V10K18G	84
50 V/m field strength for military testing applications from 2 MHz - 18 GHz	SSMIL50V2M18G	84
50 V/m field strength for military testing applications from 2 MHz - 40 GHz	SSMIL50V2M40G	84
200 V/m field strength for military testing applications from 10 kHz - 18 GHz	SSMIL200V10K18G	84
200 V/m field strength for military testing applications from 2 MHz - 18 GHz	SSMIL200V2M18G	85
200 V/m field strength for military testing applications from 2 MHz - 40 GHz	SSMIL200V2M40G	85
Conducted Immunity Test Systems		
Complete Testing Solutions 10 kHz - 400 MHz, 100 W	CI00402	86
Complete Testing Solutions 10 kHz - 400 MHz, 175 W	CI00403	86
Complete Testing Solutions 100 kHz - 1000 MHz, 250 W	CI01000	87
Multi-Tone Test Systems		
Multi-Tone RF Radiated Immunity System, 2 Tones	MT2IEC10V3M	88
Multi-Tone RF Radiated Immunity System, 4 Tones	MT4IEC10V3M	89



Multi-Tone Testing

The MT4IEC10V3M (Multi-Tone Test System) is a state-of-the-art system that is designed to run RF Radiated Immunity tests faster than ever before. By testing multiple frequencies (tones) at once, test times are reduced by a factor equivalent to the number of tones selected. The number of tones is only limited by the number of signal generators and the size of the amplifier used with the system.



Antennas

Frequency Range
10 kHz – 50 GHz

Power Range
1 W – 20 kW

 Select a Model Number to view more details

Find it Fast Table

Frequency	Power (W)	Model Number	Page
Log-Periodic			
26 – 250 MHz	15000	ATR26M250	97
26 MHz – 1 GHz	20000	ATR26M1G	97
26 MHz – 6 GHz	5000	ATR26M6G	98
26 MHz – 6 GHz	5000	ATR26M6G-1	98
80 MHz – 1 GHz	2000	ATL80M1G	99
80 MHz – 6 GHz	5000	ATR80M6G	99
150 MHz – 1 GHz	2000	ATL150M1G	100
200 MHz – 2 GHz	300	LP1	100
200 MHz – 3 GHz	250	LP3	100
200 MHz – 6 GHz	200	LP6	100
200 MHz – 6 GHz	5000	ATR200M6G	101
700 MHz – 7.5 GHz	1200	ATT700M8G	101
700 MHz – 12 GHz	600	ATT700M12G	102
30 – 2 GHz	See Graphs	JB1	102
30 – 3 GHz	See Graphs	JB3	102
30 – 6 GHz	See Graphs	JB6	102
Horn			
200 MHz – 1 GHz	5000	ATH200M1G	103
200 MHz – 1 GHz	10000	ATH200M1G-1	103
200 MHz – 2 GHz	1000	ATH200M2G	104

Frequency	Power (W)	Model Number	Page
400 MHz – 1 GHz	3000	ATH400M1G	104
800 MHz – 6 GHz	2300	ATH800M6G	105
1 – 18 GHz	300	DRH-118	105
2 – 10 GHz	700	ATH2G10	106
4 – 8 GHz	500	ATH4G8	107
6 – 8 GHz	3000	ATH6G18A	108
7.5 – 18 GHz	2800	ATH7G18A	108
18 – 26.5 GHz	350	ATH18G27A	109
18 – 26.5 GHz	350	ATH18G27A-1	109
18 – 40 GHz	50	DRH-1840	110
18 – 40 GHz	450	ATH18G40	110
26.5 – 40 GHz	240	ATH26G40A-1	111
26.5 – 40 GHz	400	ATH26G40A	111
33 – 50 GHz	240	ATH33G50	112

Frequency	Power (W)	Model Number	Page
E-Field Generators			
10 kHz – 25 MHz	3000	ATE10K25M-1	112
10 kHz – 30 MHz	1000	ATE10K30MA	113
10 kHz – 100 MHz	500	ATE10K100M	113
10 kHz – 100 MHz	3000	ATP10K100M	114
Biconical			
30 – 300 MHz	1	BC1	115
30 – 300 MHz	50	BC2	115
30 – 300 MHz	500	BC5	115
DAS Antennas			
400 MHz – 3 GHz	25	LP425PCB	116
400 MHz – 3 GHz	25	LP425PCB-O-DIN	116
400 MHz – 3 GHz	200	LP425	117
400 MHz – 6 GHz	25	LP460PCB	117
650 MHz – 3 GHz	25	LP6530PCB	118
650 MHz – 6 GHz	15	LP6560PCB	118

The antennas you need for virtually any testing procedures are right here at AR. We offer a complete variety of rugged, high power antennas, with expect field generation graphs. Since all are frequency and power matched to AR amplifiers, it's easy to precisely select the suitable unit.



Accessories

Select a Model Number to view more details

Find it Fast Table

Category	Page
1 Coaxial Cables	110
2 Dual Directional Couplers	112
3 Field Monitoring	124
4 Load Attenuators	123
5 Masts	136
6 Positioning Equipment	137
7 Power Heads	126
8 Power Meters	126
9 RF Test System Controllers	131
10 Shielded Enclosure Leak Detectors	131
11 Software	130
12 System Interlock	134
13 Turntables	135
14 USB Pulse Power Sensors	127



RF Solid State Amplifiers

All our RF solid-state amplifiers have modulation capability that will faithfully reproduce AM, FM or Pulse Modulation appearing on the input signal for use in the most demanding EMC applications. These self-contained, broadband, completely solid-state amplifiers are designed for applications requiring the ultimate in output power over a wide instantaneous bandwidth with high gain.



500A250D



RF Solid State Amplifiers

Frequency Range
10 kHz – 1 GHz

Power Range
1 W – 50 kW

100A400AM20

4 kHz – 400 MHz
100 W CW



Rated Output Power Into 50Ω:
4 kHz – 100 kHz: 10 W min. rising to 100 W min. at 100 kHz
100 kHz – 400 MHz: 125 W, typ.; 100 W min.

Input for Rated Output 1 milliwatt max.

Power Output @ 3 dB Compression Into 50Ω:
4 kHz – 100 kHz: 10 W min. rising to 100 W min. at 100 kHz
100 kHz – 400 MHz: 125 W typ.; 100 W min.

Power Output @ 1 dB Compression Into 50Ω:
4 kHz – 100 kHz: 10 W min. rising to 75 W at 100 kHz
100 kHz – 400 MHz: 85 W typ.; 75 W min.

Flatness ±1 dB typ. / ±1.5 dB max, 100 kHz – 400 MHz

Frequency Response 4 kHz–400 MHz instantaneously

Gain (at max. setting)
50 dB min., 100 kHz – 400 MHz; <50 dB below 100 kHz

Gain Adjustment (continuous range) 20 dB min.

Input Impedance 50 ohms, VSWR 2:1 max.

Output Impedance 50 ohms, nominal

Mismatch Tolerance*
100% of rated power without foldback. Will operate without damage or oscillation with any magnitude and phase of source and load impedance.

Harmonic Distortion
Minus 20 dBc max. at 75 W,
Minus 30 dBc typical at 50 W (1 – 400 MHz)

Spurious Minus 73 dBc typ.

Third Order Intercept Point 55 dBm typ.

Noise Figure 8 dB typ.

Primary Power 100 – 240 VAC, 50 / 60 Hz, 500 W

Connectors
RF Input Type N female
RF Output Type N female

Remote Interfaces
IEEE-488 24-pin female
RS-232 9-pin Subminiature D female
Fiber optic ST Conn Tx and Rx RS-232
USB 2 Type B
Ethernet RJ-45

Safety Interlock 15-pin Subminiature D

Cooling Forced air (self-contained fans)

Weight
With cabinet 18.5 kg (41 lb.)
Without cabinet 10.4 kg (23 lb.)

Size (WxHxD)
With cabinet 50.3 x 15.5 x 55.1 cm / 19.8 x 6.1 x 21.7 in.
Without cabinet 48.3 x 13.2 x 55.1 cm / 19 x 5.2 x 21.7 in.

Export classification EAR99

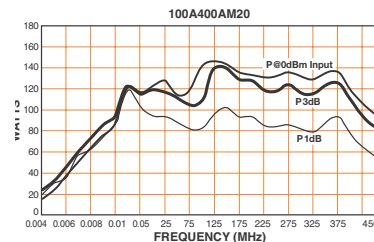

800A3B

10 kHz – 3 MHz
800 W CW



Rated Output Power 800 W

Input for Rated Output 1 milliwatt max.

Power Output @ 3 dB compression
Nominal 800 W
Min. 800 W, 10 kHz – 2 MHz
Min. 700 W, 2 – 3 MHz

Power Output @ 1 dB compression
Nominal 500 W / min. 400 W

Flatness ± 1 dB max.

Frequency Response 10 kHz – 3 MHz instantaneously

Gain (at max. setting) 60 dB min.

Gain Adjustment (continuous range) 23 dB min.

Input Impedance 50 ohms, nominal

Output Impedance (switch select; manual)
12.5, 25, 50, 100, 150, 200, 400 ohms nominal
(10 kHz–3 MHz) on front panel

Mismatch Tolerance*
Will operate without damage or oscillation with any magnitude and phase of source and load impedance. 100% of rated power without foldback up to 6:1 mismatch above which may limit to 400 W reflected power.

Harmonic Distortion
Minus 20 dBc max. at 400 W power output

Connectors
RF Input Type N female on front panel
RF Output Type N female on front panel

Remote Control
IEEE-488/RS-232, USB ability to remote control and power an external impedance transformer.

RF Power Display
0 – 1000 W full scale. Directional power monitor allows separate display of forward and reflected power.

Cooling Forced air (self-contained fans)

Primary Power 190 – 240 VAC
50 – 60 Hz, 2,500 W max.

Weight (max.)
With cabinet 36.4 kg (80 lb.)
Without cabinet 29.4 kg (65 lb.)

Size (WxHxD)
With cabinet 50.3 x 34 x 55.1 cm / 19.8 x 13.4 x 21.7 in.
Without cabinet 48.3 x 30.5 x 54.4 cm / 19 x 12 x 21.4 in.
For external impedance transformer options, see specification sheet for IT2000 Series impedance transformers.

Export classification EAR9

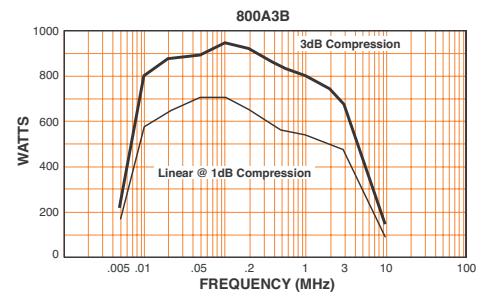

RF Solid State Amplifiers

Frequency Range
10 kHz – 1 GHz

Power Range
1 W – 50 kW

150A100D 10 kHz – 100 MHz 150 W CW



Rated Output Power	180 W typ., 150 W min.
Input for Rated Output	1 milliwatt max.
Power Output	@ 3 dB compression Typical: 165 W / min. 140 W
Power Output	@ 1 dB compression Typical: 135 W / min. 110 W
Flatness	±1 dB typ., ±1.5 dB max.
Frequency Response	10 kHz – 100 MHz instantaneously
Gain (at max. setting)	51.8 dB min.
Gain Adjustment (continuous range)	20 dB min.
Input Impedance	50 ohms, VSWR 2:1 max.
Output Impedance	50 ohms nominal.
Mismatch Tolerance*	100% of rated power without foldback. Will operate without damage or oscillation with any magnitude and phase of source and load impedance.
Noise Figure	9 dB typ.
Harmonic Distortion	Minus 20 dBc max. at 100 W Minus 30 dBc typ. at 70 W
Third Order Intercept Point	55 dBm typ.
Spurious	Minus 73 dBc typ.
Primary Power	100 – 240 VAC 50/60 Hz 500 W

Connectors	
RF Input	Type N female
RF Output	Type N female
Remote Interfaces	
IEEE-488	24-pin female
RS-232	9-pin subminiature D (female)
Fiber optic	ST Conn Tx and Rx RS-232
USB 2	Type B
Ethernet	RJ-45
Safety Interlock	15-pin subminiature D
Cooling	Forced air (self-contained fans)
Weight	
With cabinet	18.5 kg (41 lb.)
Without cabinet	10.4 kg (23 lb.)
Size (WxHxD)	
With cabinet	50.3 x 15.5 x 55.1 cm / 19.8 x 6.1 x 21.7 in.
Without cabinet	48.3 x 13.2 x 55.1 cm / 19 x 5.2 x 21.7 in.
Export classification	EAR99

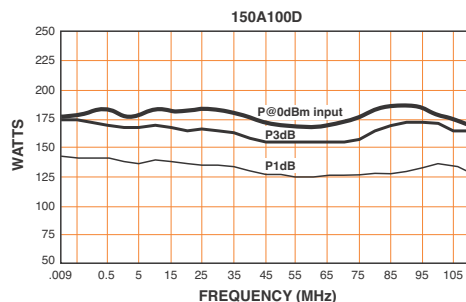

1200A225B 10 kHz – 225 MHz 1200 W CW



Rated Output Power	Typ.: 1,300 W, min. 1,200 W, .01 – 100 MHz Typ.: 1,200 W, min. 1,100 W, 100 – 225 MHz
Input for Rated Output	1 milliwatt max.
Power Output†	@ 3 dB compression Typ.: 1,300 W, min. 1,200 W, .01 – 100 MHz Typ.: 1,200 W, min. 1,100 W, 100 – 225 MHz
Power Output	@ 1 dB compression Typ.: 1,250 W, min. 1,100 W, .01 – 100 MHz Typ.: 1050 W, min. 800 W, 100 – 225 MHz
Flatness	±2 dB typ., ±2.5 dB max.
Frequency Response	10 kHz–225 MHz instantaneously
Gain (at max. setting)	61.8 dB
Gain Adjustment (continuous range)	>20 dB
Input Impedance	50 ohms, VSWR to 1.5:1 max.
Output Impedance	50 ohms nominal
Mismatch Tolerance	Will operate without damage or oscillation when connected to any load impedance without the aid of foldback circuitry.
Harmonic Distortion	Minus 30 dBc typical, minus 20 dBc maximum at 800 W
Third Order Intercept Point	73 dBm typ.
Primary Power	200 – 240 VAC single-phase 50/60 Hz 4.5 kW

Connectors	
RF Input:	N female
RF Output:	7/16 DIN female
Remote Control	
IEEE-488	24-pin female
RS-232	9-pin subminiature D (female)
Fiber optic	ST Conn Tx and Rx RS-232
USB 2	Type B
Ethernet	RJ-45
Safety Interlock	15-pin subminiature D
Cooling	Forced air (self-contained fans)
Weight	125 kg (275 lbs)
Size (WxHxD)	56.1 x 132.1 x 82.4 cm / 22.1 x 52 x 32.5 in
Export classification	EAR99

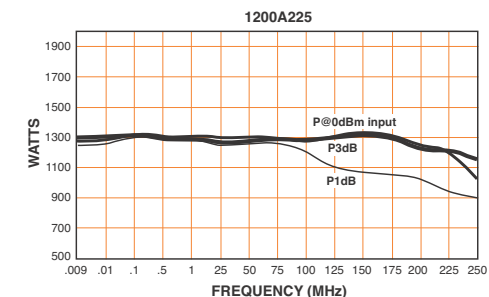

RF Solid State Amplifiers

Frequency Range
10 kHz – 1 GHz

Power Range
1 W – 50 kW

2500A225C

10 kHz – 225 MHz
2500 W CW



Rated Output Power	Typ.: 2,800 W, min. 2,500 W, .01 – 100 MHz Typ.: 2,300 W, min. 2,000 W, 100 – 225 MHz
Input for Rated Output	1 milliwatt max.
Power Output	@ 3 dB compression Typ.: 2,800 W, min. 2,500 W, .01 – 100 MHz Typ.: 2,300 W, min. 2,000 W, 100 – 200 MHz Typ.: 2,000 W, min. 1,800 W, 200 – 225 MHz
Power Output	@ 1 dB compression Typ.: 2,400 W, min. 2,000 W, .01 – 100 MHz Typ.: 1,900 W, min. 1,500 W, 100 – 200 MHz Typ.: 1,500 W, min. 1,300 W, 200 – 225 MHz
Flatness	±2 dB typ., ±2.5 dB max.
Frequency Response	10 kHz – 225 MHz instantaneously
Gain (at max. setting)	64 dB min.
Gain Adjustment (continuous range)	20 dB
Input Impedance	50 ohms, VSWR 1.5:1 max.
Output Impedance	50 ohms nominal
Mismatch Tolerance	Will operate without damage or oscillation when connected to any load impedance without the aid of foldback circuitry.
Mismatch Capability	Will faithfully reproduce AM, FM, or pulse modulation appearing on input signal.
Harmonic Distortion	Minus 30 dBc typical, minus 20 dBc maximum at 1,750 W
Third Order Intercept Point	74 dBm typ.

Spurious	Minus 70 dBc typ.
Primary Power (user must specify):	200–240 VAC or 380–415 VAC 3-phase 50/60 Hz 8.5 kW
Connectors	RF Input: N female RF Output: 7/16 DIN female Sample Ports: N female Remote Package: IEEE-488 24-pin female RS-232 9-pin subminiature D (female) Fiber optic ST Conn Tx and Rx RS-232 USB 2 Type B Ethernet RJ-45 Safety Interlock 5-pin subminiature D
Cooling	Forced air (self-contained fans)
Weight	159 kg (350 lb.)
Size (WxHxD)	56.1 x 132.1 x 82.4 cm / 22.1 x 52 x 32.5 in.
Export classification	EAR99

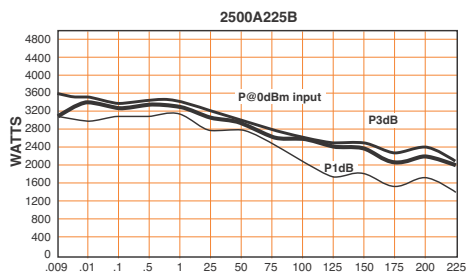

5000A225C

10 kHz – 225 MHz
5000 W CW



Rated Output Power	Typ.: 5,500 W, min. 5000 W, .01 – 100 MHz Typ.: 4,500 W, min. 4000 W, 100 – 225 MHz
Input for Rated Output	1 mW max.
Power Output	@ 3 dB compression Typical: 5,500 W, min. 5000 W, .01 – 100 MHz Typical: 4,500 W, min. 4000 W, 100 – 200 MHz Typical: 4250 W, min 3750 W, 200 – 225 MHz
Power Output	@ 1 dB compression Typical: 5000 W, min 4000 W, .01 – 100 MHz Typical: 4000 W, min 3000 W, 100 – 200 MHz Typical: 3250 W, min 2750 W, 200 – 225 MHz
Flatness	±1.5 dB typ., ±2.5 dB max.
Frequency Response	10 kHz–225 MHz instantaneously
Gain (at max. setting)	67 dB min.
Gain Adjustment (continuous range)	>20 dB
Input Impedance	50 ohms, VSWR 2:1 max.
Output Impedance	50 ohms nominal
Mismatch Tolerance	Will operate without damage or oscillation when connected to any load impedance without the aid of foldback circuitry.
Harmonic Distortion	Minus 30 dBc typ., minus 20 dBc max. at 3750 W
Third Order Intercept Point	77 dBm typ.
Spurious	Minus 70 dBc typ.
Primary Power (user must specify):	200 – 240 VAC or 380-415 VAC, 3-phase, 50/60Hz, 17 kW

Connectors	RF Input: N female RF Output: EIA 1-5/8 male, rear Remote Control: IEEE-488 24-pin female RS-232 9-pin subminiature D (female) Fiber optic ST Conn Tx and Rx RS-232 USB 2 Type B Ethernet RJ-45 Safety Interlock 15-pin subminiature D
Cooling	Forced air (self-contained fans)
Weight	295 kg (650 lbs)
Size (WxHxD)	56.1 x 181.6 x 82.4 cm (22.1 x 71.5 x 32.5 in.)
Export classification	EAR99



RF Solid State Amplifiers

Frequency Range
10 kHz – 1 GHz

Power Range
1 W – 50 kW

10000A225B 10 kHz – 225 MHz 10000 W CW



Rated Output Power	
Nominal	11000 W
Minimum	10000 W, .01 – 100 MHz, 6000 W, 100 – 225 MHz

Input for Rated Output	1 milliwatt max.
-------------------------------	------------------

Power Output for 1 dB compression	
Nominal	8000 W
Minimum	7000 W, .01 – 100 MHz, 4000 W, 100 – 225 MHz

Flatness	±3 dB max. ±1 dB with internal leveling
-----------------	--

Frequency Response	10 kHz–225 MHz instantaneously
---------------------------	--------------------------------

Gain (at max. setting)	70 dB min.
-------------------------------	------------

Gain Adjustment (continuous range)	20 dB min.
---	------------

Input Impedance	50 ohms, VSWR 2:1 max.
------------------------	------------------------

Output Impedance	50 ohms, nominal
-------------------------	------------------

Mismatch Tolerance	
100% rated power without foldback up to 6:1 mismatch above which may limit to 5000 W reflected power, from 10 kHz to 100 MHz. Limited to 3000 W reflected power from 100 MHz to 225 MHz.	

Harmonic Distortion	Minus 20 dBc max. at 6000 W
----------------------------	-----------------------------

Third Order Intercept Point	77 dBm typ.
------------------------------------	-------------

RF Power Display	0 – 15000 W full scale
-------------------------	------------------------

RF Rise/Fall Time	150 nanoseconds max.
--------------------------	----------------------

Primary Power (user must specify):	
190 – 240 VAC, Delta (4 wire)	

Frequency Range	
380 – 480 VAC, Delta (4 wire) 47 – 63 Hz, 3-phase 40000 W max. at .95 P.F. typ.	

Connectors	
RF Input	Type N female on rear panel
RF Output	Type EIA 1–5/8 male on rear panel
Forward Sample	Type N female on front panel (coupling factor 80 dB typ.)
Reverse Sample	Type N female on front panel (coupling factor 80 dB typ.)
Pulse Modulation Input	Type BNC female on rear panel
Safety Interlock	15-pin female Type D on rear panel
Remote Control	
IEEE–488	24-pin female on rear panel
RS–232	9-pin female Type D on rear panel
RS–232 (fiber optic):	Type ST, rear panel
USB 2:	Type B female, rear panel
Ethernet:	RJ–4

Cooling	
Forced air (self-contained fans)	

Weight	500 kg (1,100 lb.)
---------------	--------------------

Size (WxHxD)	
112.1 x 82.4 x 165.3 cm / 44.12 x 32.43 x 65.1 in.	

Export classification	EAR99
------------------------------	-------

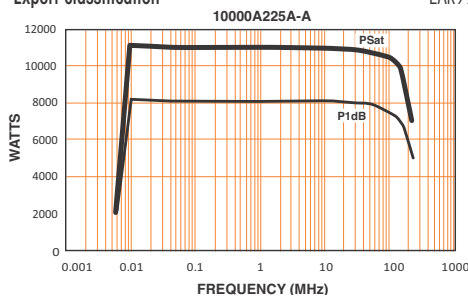

25A250B 10 kHz – 250 MHz 25 W CW



Rated Output Power	35 W typ., 25 W min.
---------------------------	----------------------

Input for Rated Output	1 milliwatt max.
-------------------------------	------------------

Power Output	@ 3 dB compression Typ. 35 W / min. 25 W
---------------------	---

Power Output	@ 1 dB compression Typ. 30 W / min. 20 W
---------------------	---

Flatness	±1 dB typ. / ±1.5 dB max.
-----------------	---------------------------

Frequency Response	10 kHz–250 MHz instantaneously
---------------------------	--------------------------------

Gain (at max. setting)	44 dB min.
-------------------------------	------------

Gain Adjustment (continuous range)	20 dB min.
---	------------

Input Impedance	50 ohms, VSWR 2:1 max.
------------------------	------------------------

Output Impedance	50 ohms, nominal
-------------------------	------------------

Mismatch Tolerance*	
100% of rated power without foldback. Will operate without damage or oscillation with any magnitude and phase of source and load impedance.	

Modulation Capability	
Will faithfully reproduce AM, FM, or pulse modulation appearing on the input signal.	

Harmonic Distortion	Minus 20 dBc max. at 20 W, Minus 35 dBc typ. at 15 W
----------------------------	---

Spurious	Minus 73 dBc typ.
-----------------	-------------------

Third Order Intercept Point	55 dBm typ.
------------------------------------	-------------

Noise Figure	8 dB typ.
---------------------	-----------

Primary Power	
100 – 240 VAC 50 / 60 Hz, 200 W	

Connectors	
RF Input	Type N female
RF Output	Type N female

Remote Interfaces	
IEEE–488	24-pin female
RS–232	9-pin Subminiature D female
Fiber optic	ST Conn Tx and Rx RS–232
USB 2	Type B
Ethernet	RJ–45

Safety Interlock	15-pin Subminiature D
-------------------------	-----------------------

Cooling	Forced air (self-contained fans)
----------------	----------------------------------

Weight	
With cabinet	16.7 kg (37 lb.)
Without cabinet	8.6 kg (19 lb.)

Size (WxHxD)	
With cabinet	50.3 x 15.5 x 55.1 cm / 19.8 x 6.1 x 21.7 in.
Without cabinet	48.3 x 13.2 x 55.1 cm / 19 x 5.2 x 21.7 in.

Export classification	EAR99
------------------------------	-------

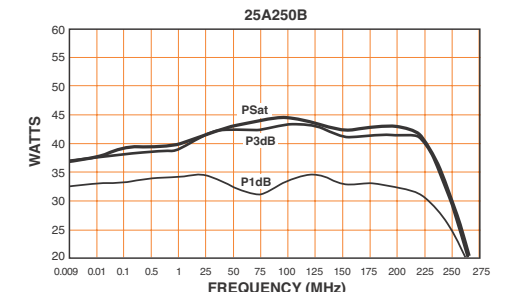

RF Solid State Amplifiers

Frequency Range
10 kHz – 1 GHz

Power Range
1 W – 50 kW

50A250

10 kHz – 250 MHz
50 W CW



Rated Output Power	70 W typ., 50 W min.
Input for Rated Output	1 milliwatt max.
Power Output	@ 3 dB compression Typ. 70 W / min. 50 W
Power Output	@ 1 dB compression Typ. 55 W / min. 40 W
Flatness	±1 dB typ. / ±1.5 dB max.
Frequency Response	10 kHz – 250 MHz instantaneously
Gain (at max. setting)	47 dB min.
Gain Adjustment (continuous range)	20 dB min.
Input Impedance	50 ohms, VSWR 2:1 max.
Output Impedance	50 ohms, nominal
Mismatch Tolerance*	100% of rated power without foldback. Will operate without damage or oscillation with any magnitude and phase of source and load impedance.
Harmonic Distortion	Minus 20 dBc max. at 40 W, Minus 30 dBc typ. at 30 W
Spurious	Minus 73 dBc typ.
Third Order Intercept Point	55 dBm typ.
Noise Figure	8 dB typ.
Primary Power	100 – 240 VAC 50 / 60 Hz, 250 W

Connectors	RF Input RF Output	Type N female Type N female
Remote Interfaces	IEEE-488 RS-232 Fiber optic USB 2 Ethernet	24-pin female 9-pin Subminiature D female ST Conn Tx and Rx RS-232 Type B RJ-45
Safety Interlock		15-pin Subminiature D
Cooling		Forced air (self-contained fans)
Weight	With cabinet Without cabinet	16.7 kg (37 lb.) 8.6 kg (19 lb.)
Size (WxHxD)	With cabinet Without cabinet	50.3 x 15.5 x 55.1 cm / 19.8 x 6.1 x 21.7 in. 48.3 x 13.2 x 55.1 cm / 19 x 5.2 x 21.7 in.
Export classification		EAR99

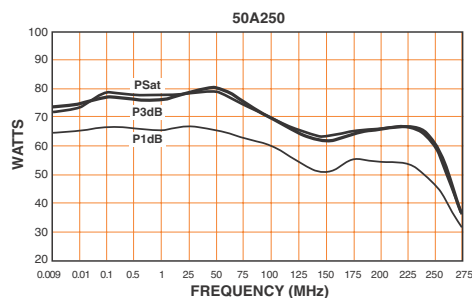

125A250

10 kHz – 250 MHz
125 W CW



Rated Output Power	150 W typ., 125 W min.
Input for Rated Output	1 milliwatt max.
Power Output	@ 3 dB compression Typical: 145 W / min. 125 W
Power Output	@ 1 dB compression Typical: 110 W / min. 90 W
Flatness	±1 dB typ., ±1.5 dB max.
Frequency Response	10 kHz – 250 MHz instantaneously
Gain (at max. setting)	50 dB min.
Gain Adjustment (continuous range)	20 dB min.
Input Impedance	50 ohms, VSWR 2:1 max.
Output Impedance	50 ohms nominal.
Mismatch Tolerance*	100% of rated power without foldback. Will operate without damage or oscillation with any magnitude and phase of source and load impedance.
Noise Figure	8 dB typ.
Harmonic Distortion	Minus 20 dBc max. at 90 W Minus 30 dBc typ. at 70 W
Third Order Intercept Point	55 dBm typ.
Spurious	Minus 73 dBc typ.
Primary Power	100 – 240 VAC 50/60 Hz 500 W

Connectors	RF Input RF Output	Type N female Type N female
Remote Interfaces	IEEE-488 RS-232 Fiber optic USB 2 Ethernet Safety Interlock	24-pin female 9-pin subminiature D (female) ST Conn Tx and Rx RS-232 Type B RJ-45 15-pin subminiature D
Cooling		Forced air (self-contained fans)
Weight	With cabinet Without cabinet	18.5 kg (41 lb.) 10.4 kg (23 lb.)
Size (WxHxD)	With cabinet Without cabinet	50.3 x 15.5 x 55.1 cm / 19.8 x 6.1 x 21.7 in. 48.3 x 13.2 x 55.1 cm / 19 x 5.2 x 21.7 in.
Export classification		EAR99

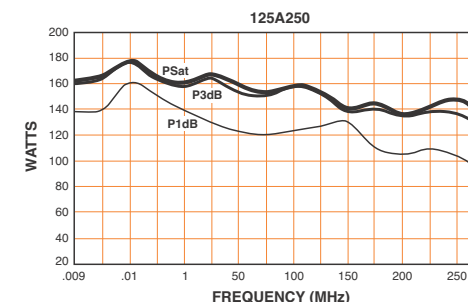

RF Solid State Amplifiers

Frequency Range
10 kHz – 1 GHz

Power Range
1 W – 50 kW

500A250D

10 kHz – 250 MHz
500 W CW



Rated Output Power	600 W typ., 500 W min., .01 – 250 MHz
Power Output	@ 3 dB compression 600 W typ., 500 W min., .01 – 250 MHz 550 W typ., 475 W min., 200 MHz – 250 MHz
Power Output	@ 1 dB compression 525 W typ., 400 W min., .01 – 250 MHz 425 W typ., 375 W min., 200 MHz – 250 MHz
Flatness	±1.5 dB typ., ±2 dB max.
Frequency Response	10 kHz–250 MHz instantaneously
Gain (at max. setting)	57 dB min.
Gain Adjustment (continuous range)	20 dB min.
Input Impedance	50 ohms, VSWR 2:1 max.
Output Impedance	50 ohms nominal.
Mismatch Tolerance*	Will operate without damage or oscillation when connected to any load impedance without the aid of foldback circuitry.
Noise Figure	7 dB typ.
Harmonic Distortion	Minus 20 dBc max. at 400 W; <-20 dBc typ. at 500 W
Third Order Intercept Point	68 dBm typ.
Spurious	Minus 73 dBc typ.
Primary Power	200 – 240 VAC 50 / 60 Hz, 2,400 W

Connectors	RF Input Type N female RF Output Type N female RF Sample Ports Type N female (optional)
Remote Interfaces	IEEE-488 24-pin female RS-232 9-pin subminiature D (female) Fiber optic ST Conn Tx and Rx RS-232 USB 2 Type B Ethernet RJ-45 Safety Interlock 15-pin subminiature D
Cooling	Forced air (self-contained fans)
Weight	With Cabinet 78 kg (171 lb.) Without Cabinet 58 kg (128 lb.)
Size (WxHxD)	With Cabinet 50.3 x 38.1 x 75.5 cm / 19.8 x 15 x 29.7 in. Without Cabinet 48.3 x 35.6 x 75.5 cm / 19 x 14 x 29.7 in.
Export classification	EAR99

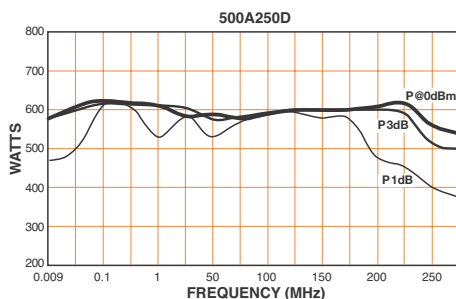

100A400A

10 kHz – 400 MHz
100 W CW



Rated Output Power	130 W typ., 100 W min.
Input for Rated Output	1 milliwatt max.
Power Output	@ 3 dB compression Typ. 125 W / min. 100 W
Power Output	@ 1 dB compression Typ. 85 W / min. 75 W
Flatness	±1 dB typ./ ±1.5 dB max.
Frequency Response	10 kHz–400 MHz instantaneously
Gain (at max. setting)	50 dB min.
Gain Adjustment (continuous range)	20 dB min.
Input Impedance	50 ohms, VSWR 2:1 max.
Output Impedance	50 ohms, nominal
Mismatch Tolerance*	100% of rated power without foldback. Will operate without damage or oscillation with any magnitude and phase of source and load impedance.
Harmonic Distortion	Minus 20 dBc max. at 75 W, Minus 30 dBc typical at 50 W
Spurious	Minus 73 dBc typ.
Third Order Intercept Point	55 dBm typ.
Noise Figure	8 dB typ.
Primary Power	100 – 240 VAC 50 / 60 Hz, 500 W

Connectors	RF Input Type N female RF Output Type N female
Remote Interfaces	IEEE-488 24-pin female RS-232 9-pin Subminiature D female Fiber optic ST Conn Tx and Rx RS-232 USB 2 Type B Ethernet RJ-45
Safety Interlock	15-pin Subminiature D
Cooling	Forced air (self-contained fans)
Weight	With cabinet 18.5 kg (41 lb.) Without cabinet 10.4 kg (23 lb.)
Size (WxHxD)	With cabinet 50.3 x 15.5 x 55.1 cm / 19.8 x 6.1 x 21.7 in. Without cabinet 48.3 x 13.2 x 55.1 cm / 19.8 x 5.2 x 21.7 in.
Export classification	EAR99

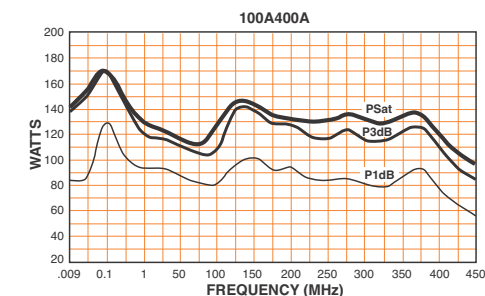

RF Solid State Amplifiers

Frequency Range
10 kHz – 1 GHz

Power Range
1 W – 50 kW

175A400

10 kHz – 400 MHz
175 W CW



Rated Output Power	225 W typ., 175 W min.
Input for Rated Output	1 milliwatt max.
Power Output	@ 3 dB compression Typ. 210 W / min. 165 W
Power Output	@ 1 dB compression Typ. 165 W / min. 125 W
Flatness	±0.9 dB typ. / ±1.5 dB max.
Frequency Response	10 kHz–400 MHz instantaneously
Gain (at max. setting)	52.5 dB min.
Gain Adjustment (continuous range)	20 dB min.
Input Impedance	50 ohms, VSWR 2:1 max.
Output Impedance	50 ohms, nominal
Mismatch Tolerance*	100% of rated power without foldback. Will operate without damage or oscillation with any magnitude and phase of source and load impedance.
Harmonic Distortion	Minus 20 dBc max. at 150 W
Spurious	Minus 73 dBc typ.
Third Order Intercept Point	60 dBm typ.
Noise Figure	8.5 dB typ.
Primary Power	100 – 240 VAC 50 / 60 Hz, 770 W

Connectors	RF Input RF Output	Type N female Type N female
Remote Interfaces	IEEE-488 RS-232 Fiber optic USB 2 Ethernet	24-pin female 9-pin Subminiature D female ST Conn Tx and Rx RS-232 Type B RJ-45
Safety Interlock		15-pin Subminiature D
Cooling		Forced air (self-contained fans)
Weight	With cabinet Without cabinet	33 kg (73 lb.) 22 kg (48 lb.)
Size (WxHxD)	With cabinet Without cabinet	50.3 x 20.5 x 74.9 cm / 19.8 x 8.1 x 29.5 in. 48.3 x 17.7 x 74.9 cm / 19 x 7 x 29.5 in.
Export Classification		EAR99

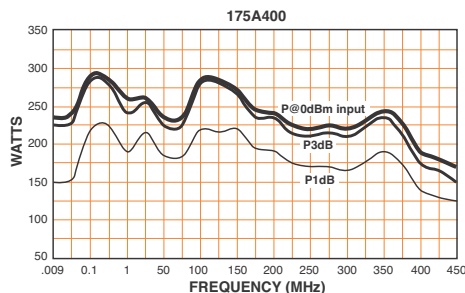

250A400

10 kHz – 400 MHz
250 W CW



Rated Output Power	325 W typ., 250 W min.
Input for Rated Output	1 milliwatt max.
Power Output	@ 3 dB compression Typ. 325 W / min. 250 W
Power Output	@ 1 dB compression Typ. 250 W / min. 200 W
Flatness	±1.5 dB typ. / ±2 dB max.
Frequency Response	10 kHz–400 MHz instantaneously
Gain (at max. setting)	54 dB min.
Gain Adjustment (continuous range)	20 dB min.
Input Impedance	50 ohms, VSWR 2:1 max.
Output Impedance	50 ohms, nominal
Mismatch Tolerance*	100% of rated power without foldback. Will operate without damage or oscillation with any magnitude and phase of source and load impedance.
Harmonic Distortion	Minus 20 dBc max. at 200 W
Spurious	Minus 73 dBc typ.
Third Order Intercept Point	65 dBm typ.
Noise Figure	8.5 dB typ.
Primary Power	100 – 240 VAC 50 / 60 Hz, 1,350 W

Connectors	RF Input RF Output	Type N female Type N female
Remote Interfaces	IEEE-488 RS-232 Fiber optic USB 2 Ethernet	24-pin female 9-pin Subminiature D female ST Conn Tx and Rx RS-232 Type B RJ-45
Safety Interlock		15-pin Subminiature D
Cooling		Forced air (self-contained fans)
Weight	With cabinet Without cabinet	45 kg (98 lb.) 33 kg (73 lb.)
Size (WxHxD)	With cabinet Without cabinet	50.3 x 20.5 x 74.9 cm / 19.8 x 8.1 x 29.5 in. 48.3 x 17.7 x 74.9 cm / 19 x 7 x 29.5 in.
Export Classification		EAR99

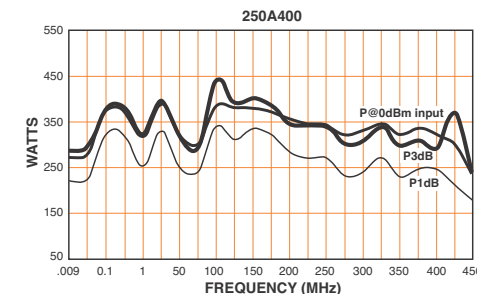

RF Solid State Amplifiers

Frequency Range
10 kHz – 1 GHz

Power Range
1 W – 50 kW

350A400

10 kHz – 400 MHz
350 W CW



Rated Output Power	425 W typ., 350 W min.
Input for Rated Output	1 milliwatt max.
Power Output	@ 3 dB compression Typ. 400 W / min. 325 W
Power Output	@ 1 dB compression Typ. 325 W / min. 225 W
Flatness	±1.5 dB typ. / ±2 dB max.
Frequency Response	10 kHz–400 MHz instantaneously
Gain (at max. setting)	55.5 dB min.
Gain Adjustment (continuous range)	20 dB min.
Input Impedance	50 ohms, VSWR 2:1 max.
Output Impedance	50 ohms, nominal
Mismatch Tolerance*	100% of rated power without foldback. Will operate without damage or oscillation with any magnitude and phase of source and load impedance.
Harmonic Distortion	Minus 20 dBc max. at 300 W
Spurious	Minus 73 dBc typ.
Third Order Intercept Point	65 dBm typ.
Noise Figure	8.5 dB typ.
Primary Power	100 – 240 VAC 50 / 60 Hz, 1,750 W

Connectors	RF Input Type N female	RF Output Type N female
Remote Interfaces	IEEE-488 24-pin female	RS-232 9-pin Subminiature D female
	Fiber optic ST Conn Tx and Rx	RS-232 ST Conn Tx and Rx
	USB 2 Type B	
	Ethernet RJ-45	
Safety Interlock	15-pin Subminiature D	
Cooling	Forced air (self-contained fans)	
Weight	With cabinet 48 kg (104 lb.)	Without cabinet 35 kg (78 lb.)
Size (WxHxD)	With cabinet 50.3 x 20.5 x 74.9 cm / 19.8 x 8.1 x 29.5 in.	Without cabinet 48.3 x 17.7 x 74.9 cm / 19 x 7 x 29.5 in.
Export Classification	EAR99	

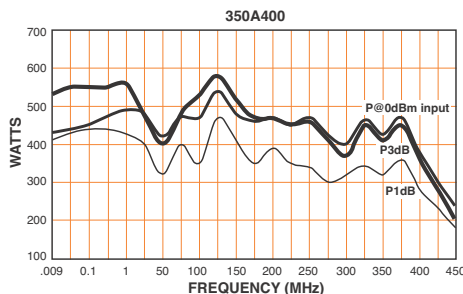

600A400

10 kHz – 400 MHz
600 W CW



Rated Output Power	700 W typ., 600 W min.; .01 – 250 MHz 600 W typ., 500 W min., 250 MHz – 400 MHz
Power Output	@ 3 dB compression 650 W typ., 600 W min.; .01 – 250 MHz 600 W typ., 500 W min., 250 MHz – 400 MHz
Power Output	@ 1 dB compression 575 W typ., 500 W min.; .01 – 250 MHz 500 W typ., 400 W min., 250 MHz – 400 MHz
Flatness	±1.5 dB typ. / ±2 dB max.
Frequency Response	10 kHz–400 MHz instantaneously
Gain (at max. setting)	57.8 dB min.
Gain Adjustment (continuous range)	20 dB min.
Input Impedance	50 ohms, VSWR 2:1 max.
Output Impedance	50 ohms, nominal
Mismatch Tolerance*	Will operate without damage or oscillation when connected to any load impedance without the aid of foldback circuitry.
Harmonic Distortion	Minus 20 dBc maximum at 500 W; ≤-20 typical at 600 W
Spurious	Minus 73 dBc typ.
Third Order Intercept Point	67 dBm typ.
Noise Figure	7.5 dB typ.
Primary Power	200 – 240 VAC 50 / 60 Hz, 2,950 W

Connectors	RF Input Type N female	RF Output Type 7/16 DIN	RF Sample Ports: Type N female (optional)
Remote Interfaces	IEEE-488 24-pin female	RS-232 9-pin Subminiature D female	Fiber optic ST Conn Tx and Rx
	USB 2 Type B		Ethernet RJ-45
Safety Interlock	15-pin Subminiature D		
Cooling	Forced air (self-contained fans)		
Weight	With cabinet 87 kg (191 lb.)	Without cabinet 68 kg (148 lb.)	
Size (WxHxD)	With cabinet 50.3 x 38.1 x 75.5 cm / 19.8 x 15 x 29.7 in.	Without cabinet 48.3 x 35.6 x 75.5 cm / 19 x 14 x 29.7 in.	
Export Classification	EAR99		

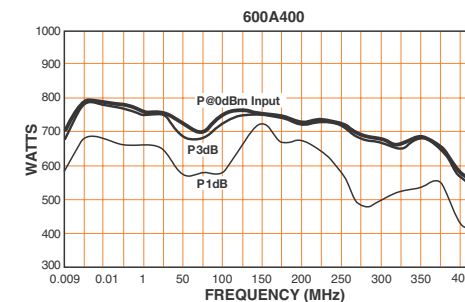

RF Solid State Amplifiers

Frequency Range
10 kHz – 1 GHz

Power Range
1 W – 50 kW

1000A400

10 kHz – 400 MHz
1000 W CW



Rated Output Power	1,200 W typ., 1000 W min.
Input for Rated Output	1 milliwatt max.
Power Output	@ 3 dB compression Typ. 1,200 W / min. 1000 W
Power Output	@ 1 dB compression Typ. 1000 W / min. 800 W
Flatness	±1.5 dB typ. / ±2 dB max.
Frequency Response	10 kHz–400 MHz instantaneously
Gain (at max. setting)	60 dB min.
Gain Adjustment (continuous range)	25 dB min.
Input Impedance	50 ohms, VSWR 2:1 max.
Output Impedance	50 ohms, nominal
Mismatch Tolerance	Will operate without damage or oscillation when connected to any load impedance without the aid of foldback circuitry.
Modulation Capability	Will faithfully reproduce AM, FM, or pulse modulation appearing on the input signal.
Harmonic Distortion	Minus 20 dBc max. at 1000 W
Spurious	Minus 73 dBc typ.
Third Order Intercept Point	68 dBm typ.
Noise Figure	8 dB typ.
Primary Power	200 – 240 VAC 3-phase, 50/60 Hz, 5.2 kW

Connectors	RF Input RF Output	Type N female 7–16 DIN female, rear
Remote Interfaces	IEEE-488 RS-232 Fiber optic USB 2 Ethernet	24-pin female 9-pin Subminiature D female ST Conn Tx and Rx RS-232 Type B RJ-45
Safety Interlock		15-pin Subminiature D
Cooling		Forced air (self-contained fans)
Weight		124.8 kg (275 lb.)
Size (WxHxD)		56.1 x 97.8 x 82.5 cm / 22.1 x 38.5 x 32.5 in.
Environmental	Operating Temperature: Operating Altitude: Shock and vibration:	5°C / +40°C Up to 2000 M Normal Truck Transport
Regulatory Compliance	EMC Safety RoHS	EN 61326-1 UL 61010-1, CAN/CSA C22.2 #61010-1 CENELEC EN 61010-1 DIRECTIVE 2011/65/EU
Export Classification		EAR99

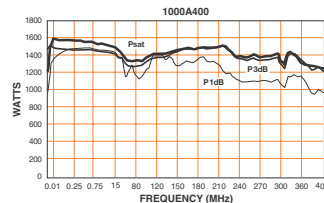

50W1000D

50 – 1000 MHz
50 W CW



Rated Output Power	70 W typ., 50 W min.
Input for Rated Output	1 milliwatt max.
Power Output	@ 3 dB compression Typ. 70 W / min. 60 W
Power Output	@ 1 dB compression Typ. 60 W / min. 45 W
Flatness	±1 dB typ. / ±1.5 dB max.
Frequency Response	50–1000 MHz instantaneously
Gain (at max. setting)	48 dB min.
Gain Adjustment (continuous range)	20 dB min.
Input Impedance	50 ohms, VSWR 2:1 max.
Output Impedance	50 ohms, nominal
Mismatch Tolerance	Will operate without damage or oscillation when connected to any load impedance without the aid of foldback circuitry.
Modulation Capability	Will faithfully reproduce AM, FM, or pulse modulation appearing on the input signal.
Harmonic Distortion	Minus 20 dBc max. at 50 W, Minus 30 dBc typ. at 50 W
Spurious	Minus 73 dBc typ.
Third Order Intercept Point	55 dBm typ.
Noise Figure	8 dB typ.

Primary Power	100 – 240 VAC 50 / 60 Hz, 250 W	
Connectors	RF Input RF Output	Type N female Type N female
Remote Interfaces	IEEE-488 RS-232 Fiber optic USB 2 Ethernet	24-pin female 9-pin Subminiature D female ST Conn Tx and Rx RS-232 Type B RJ-45
Safety Interlock		15-pin Subminiature D
Cooling		Forced air (self-contained fans)
Weight	With cabinet Without cabinet	17.7 kg (39 lb.) 9.5 kg (21 lb.)
Size (WxHxD)	With cabinet Without cabinet	50.3 x 15.5 x 55.1 cm / 19.8 x 6.1 x 21.7 in. 48.3 x 13.2 x 55.1 cm / 19.8 x 5.2 x 21.7 in.
Export classification		EAR99

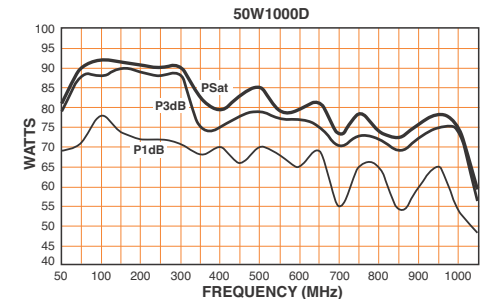

RF Solid State Amplifiers

Frequency Range
10 kHz – 1 GHz

Power Range
1 W – 50 kW

125W1000A 80 – 1000 MHz 125 W CW



Rated Output Power	140 W typical, 125 W min.
Input for Rated Output	1 milliwatt typ.
Power Output	@ 3 dB compression Nominal 130 W / min. 120 W
Power Output	@ 1 dB compression Nominal 120 W / min. 100 W
Flatness	±1.5 dB typ. / ±2 dB max.
Frequency Response	80–1000 MHz instantaneously
Gain (at max. setting)	59 dB min.
Gain Adjustment (continuous range)	22 dB min.
Input Impedance	50 ohms, VSWR 2.0:1 max.
Output Impedance	50 ohms, nominal
Mismatch Tolerance	Will operate without damage or oscillation when connected to any load impedance without the aid of foldback circuitry.
Modulation Capability	Will faithfully reproduce AM, FM, or pulse modulation appearing on input signal.
Noise Figure	8 dB max.; 6 dB typ.
Harmonic Distortion	Minus 20 dBc maximum at 100 W; minus 30 dBc typical at 100 W
Third Order Intercept Point	58 dBm typ.
Spurious	Minus 73 dBc typ.

Primary Power	100 – 240 VAC 50/60 Hz, 600 W
Connectors	RF Input Type N female on front panel RF Output Type N female on front panel
Remote Interfaces	IEEE-488 24-pin female RS-232 9-pin Subminiature D (female) Fiber Optic ST Conn Tx and Rx RS-232 USB 2 Type B Ethernet RJ-45
Safety Interlock	15-pin Subminiature D
Cooling	Forced air (self-contained fans)
Weight	With cabinet 26.5 kg (58.5 lb.) Without cabinet 15.8 kg (34.75 lb.)
Size (WxHxD)	With cabinet 51 x 17 x 65.3 cm / 20.1 x 6.7 x 25.7 in. Without cabinet 48.3 x 13.4 x 75.3 cm / 19 x 5.3 x 29.7 in.
Export Classification	EAR99

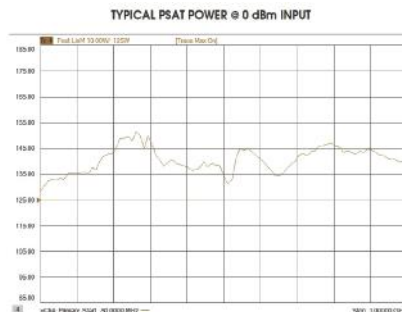

150W1000B 80 – 1000 MHz 150 W CW



Rated Output Power	160 W typical, 130 W min.
Input for Rated Output	1 milliwatt typ.
Power Output	@ 3 dB compression Nominal 150 W / min. 125 W
Power Output	@ 1 dB compression Nominal 125 W / min. 100 W
Flatness	±1.5 dB typ. / ±2 dB max.
Frequency Response	80–1000 MHz instantaneously
Gain (at max. setting)	52 dB min.
Gain Adjustment (continuous range)	20 dB min.
Input Impedance	50 ohms, VSWR 1.5:1 max.
Output Impedance	50 ohms, nominal
Mismatch Tolerance	Will operate without damage or oscillation when connected to any load impedance without the aid of foldback circuitry.
Modulation Capability	Will faithfully reproduce AM, FM, or pulse modulation appearing on input signal.
Noise Figure	8 dB max.; 6 dB typ.
Harmonic Distortion	Minus 20 dBc maximum at 100 W; minus 30 dBc typical at 100 W
Third Order Intercept Point	58 dBm typ.
Spurious	Minus 73 dBc typ.

Primary Power	100 – 240 VAC 50/60 Hz, 650 W
Connectors	RF Input Type N female on front panel RF Output Type N female on front panel
Remote Interfaces	IEEE-488 24-pin female RS-232 9-pin Subminiature D (female) Fiber Optic ST Conn Tx and Rx RS-232 USB 2 Type B Ethernet RJ-45
Safety Interlock	15-pin Subminiature D
Cooling	Forced air (self-contained fans)
Weight	With cabinet 36.7 kg (81 lb.) Without cabinet 25.4 kg (56 lb.)
Size (WxHxD)	With cabinet 50.3 x 20.5 x 74.9 cm / 19.8 x 8.1 x 29.5 in. Without cabinet 48.3 x 17.7 x 74.9 cm / 19 x 7 x 29.5 in.
Export Classification	EAR99

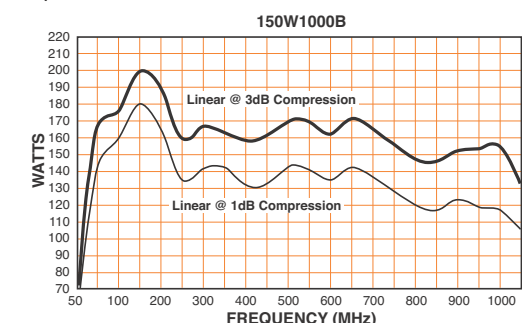

Product Catalog | 2023

For Sales, call: 215.723.8181

For an Applications Engineer, call: 800.933.8181

arworld.us

21

Contents

Find it Fast

RF Solid State

Universal Series

Microwave

Solid State Pulse

TWT

Systems

Antennas

Accessories

Contact

AR Companies

RF Solid State Amplifiers

Frequency Range
10 kHz – 1 GHz

Power Range
1 W – 50 kW

250W1000C 250 – 1000 MHz 250 W CW



Rated Output Power	300 W typ., 250 W min.
Input for Rated Output	1 milliwatt max.
Power Output	@ 3 dB compression Typical: 300 W, Minimum: 275 W up to 500 MHz; 250 W 500 – 1000 MHz
Power Output	@ 1 dB compression Typical: 250 W, Minimum: 225 W up to 500 MHz; 200 W 500 – 1000 MHz
Flatness	±2 dB max. / 1.5 dB typ.
Frequency Response	80–1000 MHz instantaneously
Gain (at max. setting)	54 dB min.
Gain Adjustment (continuous range)	20 dB min.
Input Impedance	50 ohms, VSWR 1.5:1 max.
Output Impedance	50 ohms, nominal
Mismatch Tolerance	Will operate without damage or oscillation when connected to any load impedance without the aid of foldback circuitry.
Modulation Capability	Will faithfully reproduce AM, FM, or pulse modulation appearing on input signal.
Noise Figure	8 dB max.; 6 dB typ.
Harmonic Distortion	Minus 20 dBc maximum at 200 W; minus 30 dBc typical at 200 W
Third Order Intercept Point	62 dBm typ.
Spurious	Minus 73 dBc typ.

Primary Power	100 – 240 VAC 50/60 Hz, 1000 W
Connectors	RF Input Type N female on front panel RF Output Type N female on front panel
Remote Interfaces	IEEE-488 24-pin female RS-232 9-pin Subminiature D (female) Fiber Optic ST Conn Tx and Rx RS-232 USB 2 Type B Ethernet RJ-45
Safety Interlock	15-pin Subminiature D
Cooling	Forced air (self-contained fans)
Weight	With cabinet 42.6 kg (94 lb.) Without cabinet 31.3 kg (69 lb.)
Size (WxHxD)	With cabinet 50.3 x 20.5 x 74.9 cm / 19.8 x 8.1 x 29.5 in. Without cabinet 48.3 x 17.7 x 74.9 cm / 19 x 7 x 29.5 in.
Export Classification	EAR99

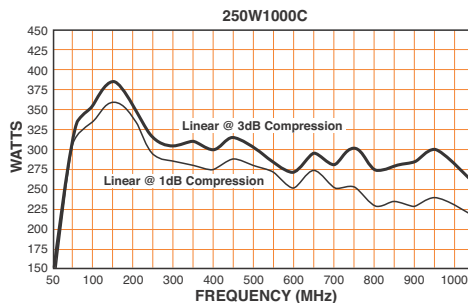

500W1000C 80 – 1000 MHz 500 W CW



Rated Output Power	600 W typ., 500 W Minimum
Input for Rated Output	1 mW max.
Power Output	@ 3 dB compression Typical: 575 W, Minimum: 525 W up to 700 MHz; 475 W 700 – 1000 MHz
Power Output	@ 1 dB compression Typical: 500 W, Minimum: 450 W up to 700 MHz; 425 W 700 – 1000 MHz
Flatness	±1 dB max. / 1.5 dB typ.
Frequency Response	80–1000 MHz instantaneously
Gain (at max. setting)	57 dB min.
Gain Adjustment (continuous range)	25 dB min.
Input Impedance	50 ohms, VSWR 1.5:1 max.
Output Impedance	50 ohms, nominal
Mismatch Tolerance	Will operate without damage or oscillation when connected to any load impedance without the aid of foldback circuitry.
Modulation Capability	Will faithfully reproduce AM, FM, or pulse modulation appearing on input signal.
Noise Figure	8 dB max.; 6 dB typ.
Harmonic Distortion	Minus 20 dBc maximum at 425 W; minus 30 dBc typical at 425 W
Third Order Intercept Point	63 dBm typ.
Spurious	Minus 73 dBc typ.

Primary Power	100 – 240 VAC 50/60 Hz, 1,800 W
Connectors	RF Input Type N female RF Output Type N female
Remote Interfaces	IEEE-488 24-pin female RS-232 9-pin Subminiature D (female) Fiber Optic ST Conn Tx and Rx RS-232 USB 2 Type B Ethernet RJ-45
Safety Interlock	15-pin Subminiature D
Cooling	Forced air (self-contained fans)
Weight	With cabinet 69.4 kg (153 lb.) Without cabinet 50.8 kg (112 lb.)
Size (WxHxD)	With cabinet 50.3 x 38.1 x 74.9 cm / 19.8 x 15 x 29.5 in. Without cabinet 48.3 x 35.6 x 74.9 cm / 19 x 14 x 29.5 in.
Export Classification	EAR99

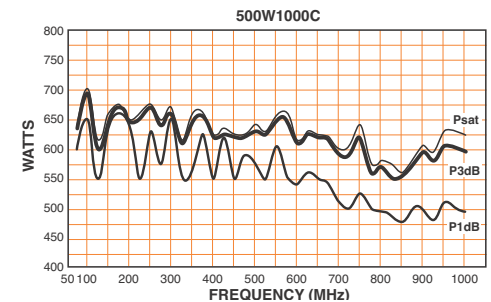

RF Solid State Amplifiers

Frequency Range
10 kHz – 1 GHz

Power Range
1 W – 50 kW

800W1000

80 – 1000 MHz
800 W CW



Rated Output Power (80 - 650 MHz)	850 W typ., 800 W min.
Rated Output Power (650 - 1000 MHz)	800 W typ., 750 W min.
Input for Rated Output	1 milliwatt max.
Power Output	@ 3 dB compression Typical: 800 / 725 min. up to 950 MHz
Power Output	@ 1 dB compression Typical: 700 W / 650 W min. up to 800 MHz
Flatness	±2.0 dB max; ±1.5 dB typ.
Frequency Response	80–1000 MHz instantaneously
Gain (at max. setting)	62 dB min.
Gain Adjustment (continuous range)	20 dB min.
Input Impedance	50 ohms, VSWR 1.5:1 max.
Output Impedance	50 ohms, nominal
Mismatch Tolerance	Will operate without damage or oscillation when connected to any load impedance without the aid of foldback circuitry.
Modulation Capability	Will faithfully reproduce AM, FM, or pulse modulation appearing on input signal.
Harmonic Distortion	Minus 20 dBc max. at 900 W Minus 20 dBc typ. @ 1000 W
Third Order Intercept Point	66 dBm typ.
Spurious	Minus 73 dBc typ.
Noise Figure	8 dB max., 6 dB typ.

Primary Power	200 – 240 VAC 50 / 60 Hz, 2,500W
Connectors	RF Input Type N female RF Output Type 7–16 DIN female on rear panel
Remote Interfaces	IEEE–488 24–pin female RS–232 9–pin Subminiature D (female) Fiber Optic ST Conn Tx and Rx RS–232 USB 2 Type B Ethernet RJ–45
Safety Interlock	15–pin Subminiature D
Cooling	Forced air (self–contained fans)
Weight (with cabinet)	58.5 kg (129 lb.)
Weight (without cabinet)	44.9 kg (99 lb.)
Size (WxHxD)	50.3 x 47 x 65.3 cm (19.8 x 18.5 x 25.7 in.)
Export Classification	EAR99

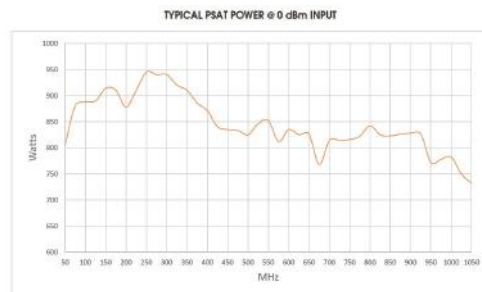

1000W1000H

80 – 1000 MHz
1000 W CW



Rated Output Power	1,200 W typ., 1000 W min.
Input for Rated Output	1 milliwatt max.
Power Output	@ 3 dB compression Typical: 1,200 W / 1,100 W min. up to 700 MHz; 950 W from 700 – 1000 MHz
Power Output	@ 1 dB compression Typical: 1000 W / 975 W min. up to 700 MHz; 900 W from 700 – 1000 MHz
Flatness	±1.5 dB max; ±1 dB typ.
Frequency Response	80–1000 MHz instantaneously
Gain (at max. setting)	60 dB min.
Gain Adjustment (continuous range)	25 dB min.
Input Impedance	50 ohms, VSWR 1.5:1 max.
Output Impedance	50 ohms, nominal
Mismatch Tolerance	Will operate without damage or oscillation when connected to any load impedance without the aid of foldback circuitry.
Modulation Capability	Will faithfully reproduce AM, FM, or pulse modulation appearing on input signal.
Harmonic Distortion	Minus 20 dBc max. at 900 W Minus 20 dBc typ. @ 1000 W
Third Order Intercept Point	66 dBm typ.
Spurious	Minus 73 dBc typ.
Noise Figure	8 dB max., 6 dB typ.

Primary Power	200 – 240 VAC 50 / 60 Hz, 3,400 W
Connectors	RF Input Type N female RF Output Type 7–16 DIN female on rear panel
Remote Interfaces	IEEE–488 24–pin female RS–232 9–pin Subminiature D (female) Fiber Optic ST Conn Tx and Rx RS–232 USB 2 Type B Ethernet RJ–45
Safety Interlock	15–pin Subminiature D
Cooling	Forced air (self–contained fans)
Weight	124.8 kg (275 lb.)
Size (WxHxD)	56.1 x 97.8 x 82.5 cm / 22.1 x 38.5 x 32.5 in.
Export Classification	EAR99

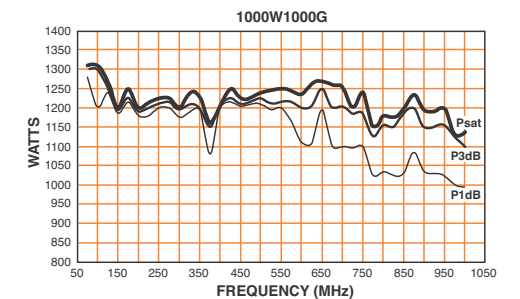

RF Solid State Amplifiers

Frequency Range
10 kHz – 1 GHz

Power Range
1 W – 50 kW

2000W1000E 80 – 1000 MHz 2000 W CW



Rated Output Power 2,200 W typ., 2000 W min.

Input for Rated Output 1 milliwatt max.

Power Output @ 3 dB compression
Nominal 2,200 W / 2000 W min. up to 700 MHz;
1,800 W from 700 – 1000 MHz

Power Output @ 1 dB compression
Nominal 1,850 W / 1,750 W min. up to 700 MHz;
1,600 W min. from 700 – 1000 MHz

Flatness ±2 dB max. / ±1.5 dB typ.

Frequency Response 80–1000 MHz instantaneously

Gain (at max. setting) 63 dB min.

Gain Adjustment (continuous range) 25 dB min.

Input Impedance 50 ohms, VSWR 1.5:1 max.; 1.3:1 typ.

Output Impedance 50 ohms, nominal

Mismatch Tolerance
Will operate without damage or oscillation when connected to any load impedance without the aid of foldback circuitry.

Harmonic Distortion Minus 20 dBc max. at 1,800 W,
–20 dBc typ. at 2000 W

Third Order Intercept Point 70 dBm typ.

Spurious Minus 73 dBc typ.

Noise Figure 8 dB max., 6 dB typ.

Primary Power (user must specify)
200 – 240 VAC, Delta-connected (4–wire)
380 – 415 VAC, Wye-connected (5–wire)
50 / 60 Hz, 3 phase, 9000 W

Connectors
RF Input Type N female on rear panel
RF Output Type 1 5/8 female on rear panel
Forward Sample N female, front (–63 dBc)
Reverse Sample N female, front (–63 dBc)
Remote Interfaces:
IEEE–488 24–pin female
RS–232 9–pin Subminiature D, female
Fiber Optic ST Conn Tx and Rx RS–232
USB 2 Type B
Ethernet RJ–45
Safety Interlock 15–pin female subminiature D, rear panel

Cooling Forced air (self-contained fans)

Weight (approximate) 218 kg (480 lb.)

Size (WxHxD) (3 cabinets)
56.1 x 175.3 x 97.6 cm / 22.1 x 69 x 38.4 in.

Export Classification EAR99

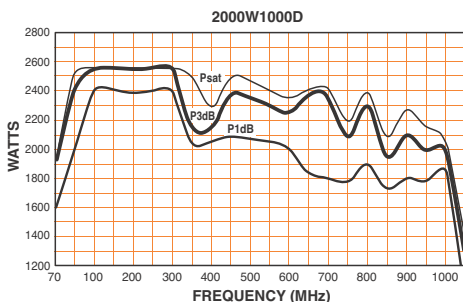

3000W1000B 80 – 1000 MHz 3000 W CW



Rated Output Power 3000 W typ., 2800 W min

Input for Rated Output 1 milliwatt max.

Power Output @ 3 dB compression
Nominal 3000 W / 2,600 W min. up to 500 MHz;
2,400 W from 500 – 1000 MHz

Power Output @ 1 dB compression
Nominal 2,500 W / 2,250 W min. up to 500 MHz;
1,850 W from 500 – 1000 MHz

Flatness ±2 dB max. / ±1.5 dB typ.

Frequency Response 80 – 1000 MHz instantaneously

Gain (at max. setting) 64.8 dB min.

Gain Adjustment (continuous range) 25 dB min.

Input Impedance 50 ohms, VSWR 1.5:1 max.; 1.3:1 typ.

Output Impedance 50 ohms, nominal

Mismatch Tolerance
Will operate without damage or oscillation when connected to any load impedance without the aid of foldback circuitry. However, mismatch above 6:1 may limit output to 1,500 W reflected power.

Harmonic Distortion Minus 20 dBc max. at 2,400 W,
–20 dBc typ. at 3000 W

Third Order Intercept Point 72 dBm typ.

Noise Figure 8 dB max., 6 dB typ.

Primary Power (user must specify)
200 – 240 VAC, Delta connected (4–wire)
360 – 435 VAC, Wye connected (5–wire)
50 / 60 Hz, 3 phase, 14 kVA

Connectors
RF Input Type N female on rear panel
RF Output Type 1 5/8 female on rear panel
Forward Sample Type N female, front (–70 dBc)
Reverse Sample Type N female, front (–70 dBc)
Remote Interfaces:
IEEE–488 24–pin female
RS–232 9–pin Subminiature D, female
Fiber Optic ST Conn Tx and Rx RS–232
USB 2 Type B
Ethernet RJ–45
Safety Interlock 15–pin female subminiature D, rear panel

Cooling Forced air (self-contained fans), enters front and bottom

Weight (approximate) 364 kg (800 lb.)

Size (WxHxD) (2 joined cabinets)
111.8 x 177.8 x 97.6 cm / 44 x 70 x 38.4 in.

Export classification EAR99

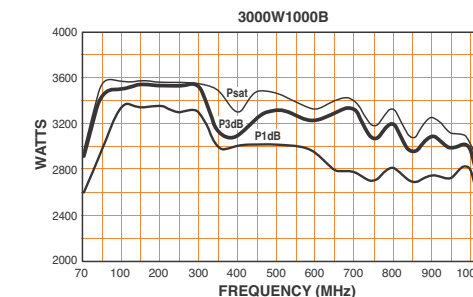

RF Solid State Amplifiers

Frequency Range
10 kHz – 1 GHz

Power Range
1 W – 50 kW

4000W1000B 80 – 1000 MHz 4000 W CW



Rated Output Power	4000 W typ., 3700 W min.
Input for Rated Output	1 milliwatt max.
Power Output	@ 3 dB compression Nominal 4000 W / 3,600 W min. up to 500 MHz; 3,400 W from 500 – 1000 MHz
Power Output	@ 1 dB compression Nominal 3,500 W / 3000 W min. up to 500 MHz; 2,500 W from 500 – 1000 MHz
Flatness	±2 dB max. / ±1.5 dB typ.
Frequency Response	80 – 1000 MHz instantaneously
Gain (at max. setting)	66 dB min.
Gain Adjustment (continuous range)	25 dB min.
Input Impedance	50 ohms, VSWR 1.5:1 max.; 1.3:1 typ.
Output Impedance	50 ohms, nominal

Mismatch Tolerance*

Will operate without damage or oscillation when connected to any load impedance without the aid of foldback circuitry. However, mismatch above 6:1 may limit output to 2000 W reflected power.

Harmonic Distortion	Minus 20 dBc max. at 3,400 W, -20 dBc typ. at 4000 W
---------------------	---

Third Order Intercept Point	73 dBm typ.
-----------------------------	-------------

Noise Figure	8 dB max., 6 dB typ.
--------------	----------------------

Primary Power (user must specify)

200 – 240 VAC, Delta connected (4-wire)
360 – 435 VAC, Wye connected (5-wire)
50 / 60 Hz, 3 phase, 17.5 kVA

Connectors

RF Input	Type N female on rear panel
RF Output	Type 1 5/8 female on rear panel
Forward Sample	Type N female, front (-70 dBc)
Reverse Sample	Type N female, front (-70 dBc)
Remote Interfaces:	
IEEE-488	24-pin female
RS-232	9-pin Subminiature D, female
Fiber Optic	ST Conn Tx and Rx RS-232
USB 2	Type B
Ethernet	RJ-45
Safety Interlock	15-pin female subminiature D, rear panel

Cooling

Forced air (self-contained fans), enters front and bottom

Weight (approximate)	432 kg (950 lb.)
----------------------	------------------

Size (WxHxD) (2 joined cabinets)	111.8 x 177.8 x 82.3 cm / 44 x 70 x 38.4 in.
----------------------------------	--

Export classification	EAR99
-----------------------	-------

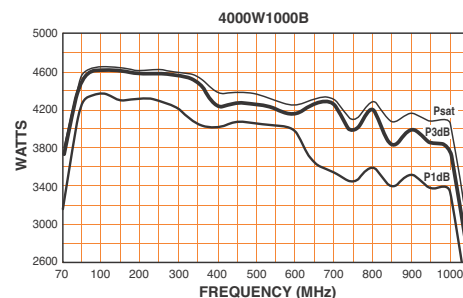

6000W1000 80 – 1000 MHz 6000 W CW



Rated Output Power	6000 W min.
Input for Rated Output	1 milliwatt max.
Power Output	@ 3 dB compression Nominal 6000 W / 5,500 W min. up to 700 MHz; 5,100 W from 700 – 1000 MHz
Power Output	@ 1 dB compression Nominal 5,500 W / 5000 W min. up to 700 MHz; 4,500 W from 700 – 1000 MHz
Flatness	±2 dB max. / ±1.5 dB typ.
Frequency Response	80–1000 MHz instantaneously
Gain (at max. setting)	67.8 dB min.
Gain Adjustment (continuous range)	25 dB min.
Input Impedance	50 ohms, VSWR 1.5:1 max.; 1.3:1 typ.
Output Impedance	50 ohms, nominal

Mismatch Tolerance*

Will operate without damage or oscillation when connected to any load impedance without the aid of foldback circuitry. However, mismatch above 6:1 may limit output to 3000 W reflected power.

Harmonic Distortion	Minus 20 dBc max. at 5,500 W, -20 dBc typ. at 6000 W
---------------------	---

Third Order Intercept Point	75 dBm typ.
-----------------------------	-------------

Noise Figure	8 dB max., 6 dB typ.
--------------	----------------------

Primary Power (user must specify)

200 – 240 VAC, Delta connected (4-wire)
360 – 435 VAC, Wye connected (5-wire)
50 / 60 Hz, 3 phase, 24 kVA

Connectors

RF Input	Type N female on rear panel
RF Output	Type 3 1/8 EIA female on rear panel
Forward Sample	Type N female, front (-70 dBc)
Reverse Sample	Type N female, front (-70 dBc)
Remote Interfaces:	
IEEE-488	24-pin female
RS-232	9-pin Subminiature D, female
Fiber Optic	ST Conn Tx and Rx RS-232
USB 2	Type B
Ethernet	RJ-45
Safety Interlock	15-pin female subminiature D, rear panel

Cooling

Forced air (self-contained fans), enters front and bottom

Weight (approximate)	703 kg (1,550 lb.)
----------------------	--------------------

Size (WxHxD) (3 joined cabinets)	170 x 183 x 99 cm / 67 x 72 x 39 in.
----------------------------------	--------------------------------------

Export classification	EAR99
-----------------------	-------

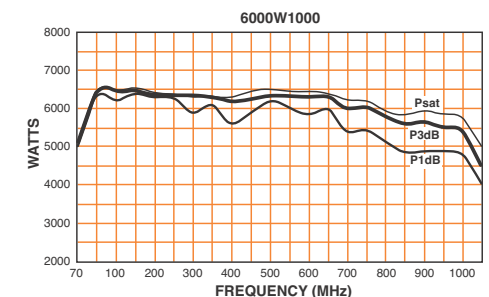

RF Solid State Amplifiers

Frequency Range
10 kHz – 1 GHz

Power Range
1 W – 50 kW



10000W1000A
80 – 1000 MHz
10000 W CW

Rated Output Power Nominal, 12,500 W
12000 W min. up to 700 MHz
10,500 W min., 700 – 1000 MHz

Input for Rated Output 1 milliwatt max.

Power Output @ 3 dB compression
Nominal 12,500 W / 12000 W min. up to 700 MHz;
10000 W from 700 – 1000 MHz

Power Output @ 1 dB compression
Nominal 11000 W / 10,500 W min. up to 700 MHz;
9,500 W from 700 – 1000 MHz

Flatness ±2 dB max. / ±1.5 dB typ.

Frequency Response 80–1000 MHz instantaneously

Gain (at max. setting) 70 dB min.

Gain Adjustment (continuous range) 25 dB min.

Input Impedance 50 ohms, VSWR 1.5:1 max.; 1.3:1 typ.

Output Impedance 50 ohms, nominal

Mismatch Tolerance
Will operate without damage or oscillation when connected to any load impedance without the aid of foldback circuitry. However, mismatch above 6:1 may limit output to 6000 W reflected power.

Modulation Capability
Faithfully reproduces AM, FM, or pulse modulation appearing on input signal.

Harmonic Distortion Minus 20 dBc max. at 10000 W,
–25 dBc typ. at 10000 W

Third Order Intercept Point 78 dBm typ.

Noise Figure 8 dB max., 6 dB typ.

Primary Power (specify voltage)
200 – 240 VAC, Delta connected (4–wire),
360 – 435 VAC, Wye connected (5–wire)
50 / 60 Hz, three phase, 48000W

Connectors
RF Input Type N female on rear panel
RF Output Type 4–1/16 EIA, rear panel
Forward Sample N female, front (–70 dBc)
Reverse Sample N female, front (–70 dBc)
Remote Interfaces:
IEEE–488 24–pin female
RS–232 9–pin Subminiature D, female
Fiber Optic ST Conn Tx and Rx RS–232
USB 2 Type B
Ethernet RJ–45
Safety Interlock 15–pin female subminiature D, rear panel

Cooling
Forced air (self–contained fans), enters front and bottom

SYSTEM (2 3–bay racks):

Weight (approximate) 1,407 kg (3,100 lb.)

Size (WxHxD)
340 x 183 x 99 cm / 134 x 72 x 39 in.

Export classification EAR99

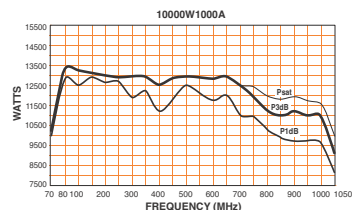

Universal Series Amplifiers

The "U" Series is a customizable, Class A design is ideal for universal applications such as laboratory and EMC testing, testing antennas, components, piezoelectric devices, wireless chargers, and more. The "U" Series are single band amplifiers available in 3dB increments, up to 500 W of power, and span 10 kHz - 1000 MHz.



Universal Series Amplifiers

Frequency Range
10 kHz – 1000 MHz

Power Range
1 – 500 W

1U1000 10 kHz – 1000 MHz 1 W CW



Rated Output Power	1 watt min.
Input for Rated Output	1 milliwatt max.
Power Output	@ 3 dB compression Typ. 1.5 W / min. 1 watt
Power Output	@ 1 dB compression Typ. 1.5 W / min. 1 watt
Flatness	±0.8 dB typ., ±1 dB max.
Frequency Response	10 kHz – 1000 MHz instantaneously
Gain (at max. setting)	30 dB min.
Gain Adjustment (continuous range)	20 dB min.
Input Impedance	50 ohms, VSWR 2:1 max.
Output Impedance	50 ohms, nominal
Mismatch Tolerance	Will operate without damage or oscillation when connected to any load impedance without the aid of foldback circuitry.
Modulation Capability	Will faithfully reproduce AM, FM, or pulse modulation appearing on the input signal.
Third Order Intercept Point	42 dBm typ.
Noise Figure	8 dB max., 6 dB typ.
Harmonic Distortion	Minus 20 dBc max. at 1 watt, minus 30 dBc typ.
Spurious	Minus 73 dBc typ.
Primary Power (selected automatically)	90 – 264 VAC 50/60 Hz, 50 W

Connectors	RF Input Type N female on front panel RF Output Type N female on front panel
Cooling	Forced air (self-contained fans)
Weight	4.5 kg (11 lb.)
Size (WxHxD)	26 x 11.4 x 28.2 cm / 10.25 x 4.5 x 11.1 in.
Export classification	EAR99

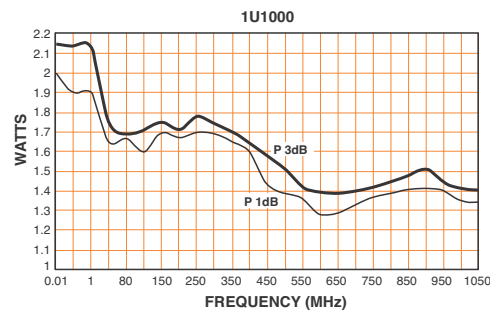

2.5U1000 10 kHz – 1000 MHz 2.5 W CW



Rated Output Power	2.5 W min.
Input for Rated Output	1 milliwatt max.
Power Output	@ 3 dB compression Typ. 3 W / min. 2.5 W
Power Output	@ 1 dB compression Typ. 2.5 W / min. 2 W
Flatness	±0.8 dB typ., ±1 dB max.
Frequency Response	10 kHz–1000 MHz instantaneously
Gain (at max. setting)	33 dB min.
Gain Adjustment (continuous range)	20 dB min.
Input Impedance	50 ohms, VSWR 2:1 max.
Output Impedance	50 ohms, nominal
Mismatch Tolerance	Will operate without damage or oscillation when connected to any load impedance without the aid of foldback circuitry.
Modulation Capability	Will faithfully reproduce AM, FM, or pulse modulation appearing on the input signal.
Third Order Intercept Point	45 dBm typ.
Noise Figure	8 dB max., 6 dB typ.
Harmonic Distortion	Minus 20 dBc max. at 2 W
Spurious	Minus 73 dBc typ.
Primary Power (selected automatically)	90–264 VAC 50/60 Hz, 50 W

Connectors	RF Input Type N female on front panel RF Output Type N female on front panel
Cooling	Forced air (self-contained fans)
Weight	4.5 kg (11 lb.)
Size (WxHxD)	26 x 11.4 x 28.2 cm / 10.25 x 4.5 x 11.1 in.
Export classification	EAR99

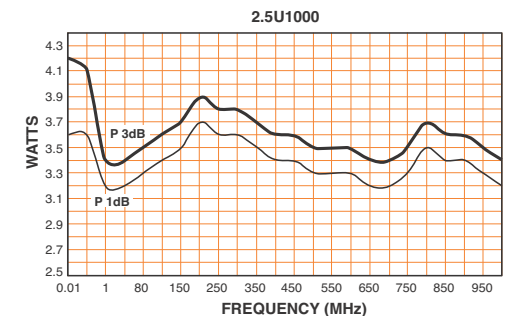

Universal Series Amplifiers

Frequency Range
10 kHz – 1000 MHz

Power Range
1 – 500 W

5U1000 10 kHz – 1000 MHz 5 W CW



Rated Output Power	5 W min.
Input for Rated Output	1 milliwatt max.
Power Output	@ 3 dB compression Typ. 5 W / min. 4.5 W
Power Output	@ 1 dB compression Typ. 4 W / min. 3.5 W
Flatness	±1.3 dB typ., ±1.5 dB max.
Frequency Response	10 kHz – 1000 MHz instantaneously
Gain (at max. setting)	37 dB min.
Gain Adjustment (continuous range)	20 dB min.
Input Impedance	50 ohms, VSWR 2:1 max.
Output Impedance	50 ohms, nominal
Mismatch Tolerance	Will operate without damage or oscillation when connected to any load impedance without the aid of foldback circuitry.
Modulation Capability	Will faithfully reproduce AM, FM, or pulse modulation appearing on the input signal.
Third Order Intercept Point	46 dBm typ.
Noise Figure	8 dB max., 6 dB typ.
Harmonic Distortion	Minus 20 dBc max. at 3.5 W
Spurious	Minus 73 dBc typ.
Primary Power (selected automatically)	90 – 264 VAC 50/60 Hz, 70 W

Connectors	RF Input RF Output	Type N female on front panel Type N female on front panel
Cooling	Forced air (self-contained fans)	
Weight	4.5 kg (11 lb.)	
Size (WxHxD)	26 x 11.4 x 28.2 cm / 10.25 x 4.5 x 11.1 in.	
Export classification	EAR99	

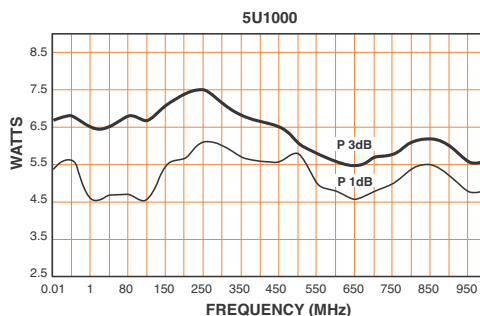

10U1000 10 kHz – 1000 MHz 10 W CW



Rated Output Power	15 W typ., 10 W min.
Input for Rated Output	1 milliwatt max.
Power Output	@ 3 dB compression Typ. 15 W / min. 10 W
Power Output	@ 1 dB compression Typ. 12 W / min. 10 W
Flatness	±1 dB typ., ±1.5 dB max.
Frequency Response	10 kHz – 1000 MHz instantaneously
Gain (at max. setting)	40 dB min.
Gain Adjustment (continuous range)	20 dB min.
Input Impedance	50 ohms, VSWR 2:1 max.
Output Impedance	50 ohms, nominal
Mismatch Tolerance	Will operate without damage or oscillation when connected to any load impedance without the aid of foldback circuitry.
Modulation Capability	Will faithfully reproduce AM, FM, or pulse modulation appearing on the input signal.
Third Order Intercept Point	50 dBm typ.
Noise Figure	8 dB typ.
Harmonic Distortion	Minus 20 dBc max. at 10 W
Spurious	Minus 73 dBc typ.
Primary Power (selected automatically)	100 – 240 VAC 50/60 Hz, 150 W

Connectors	RF Input RF Output	Type N female Type N female
Remotes Package	IEEE-488 RS-232 Fiber optic USB 2 Ethernet Safety Interlock	24-pin female 9-pin subminiature D (female) ST Conn Tx and Rx RS-232 Type B RJ-45 15-pin subminiature D
Cooling	Forced air (self-contained fans)	
Weight	With Cabinet Without Cabinet	17.7 kg (41 lb.) 9.5 kg (23 lb.)
Size (WxHxD)	With Cabinet Without Cabinet	50.3 x 15.5 x 55.1 cm / 19.8 x 6.1 x 21.7 in. 48.3 x 13.2 x 55.1 cm / 19 x 5.2 x 21.7 in.
Export classification	EAR99	

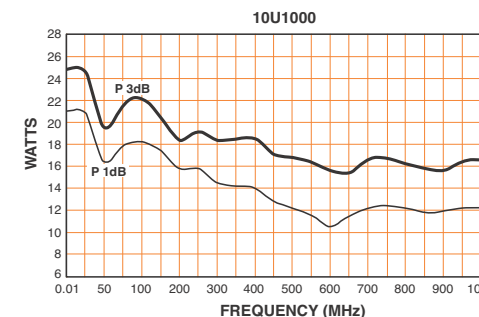

Universal Series Amplifiers

Frequency Range
10 kHz – 1000 MHz

Power Range
1 – 500 W

25U1000 10 kHz – 1000 MHz 25 W CW



Rated Output Power	30 W typ., 25 W min.
Input for Rated Output	1 milliwatt max.
Power Output	@ 3 dB compression Typ. 30 W / min. 25 W
Power Output	@ 1 dB compression Typ. 25 W / min. 20 W
Flatness	±1 dB typ., ±1.5 dB max.
Frequency Response	10 kHz – 1000 MHz instantaneously
Gain (at max. setting)	44 dB min.
Gain Adjustment (continuous range)	20 dB min.
Input Impedance	50 ohms, VSWR 2:1 max.
Output Impedance	50 ohms, nominal
Mismatch Tolerance	Will operate without damage or oscillation when connected to any load impedance without the aid of foldback circuitry.
Modulation Capability	Will faithfully reproduce AM, FM, or pulse modulation appearing on the input signal.
Third Order Intercept Point	52 dBm typ.
Noise Figure	8 dB typ.
Harmonic Distortion	Minus 20 dBc max. at 20 W
Spurious	Minus 73 dBc typ.
Primary Power (selected automatically)	100 – 240 VAC 50/60 Hz, 200 W

Connectors	RF Input RF Output	Type N female Type N female
Remotes Package	IEEE-488 RS-232 Fiber optic USB 2 Ethernet Safety Interlock	24-pin female 9-pin subminiature D (female) ST Conn Tx and Rx RS-232 Type B RJ-45 15-pin subminiature D
Cooling	Forced air (self-contained fans)	
Weight	With Cabinet Without Cabinet	17.7 kg (41 lb.) 9.5 kg (23 lb.)
Size (WxHxD)	With Cabinet Without Cabinet	50.3 x 15.5 x 55.1 cm / 19.8 x 6.1 x 21.7 in. 48.3 x 13.2 x 55.1 cm / 19 x 5.2 x 21.7 in.
Export classification	EAR99	

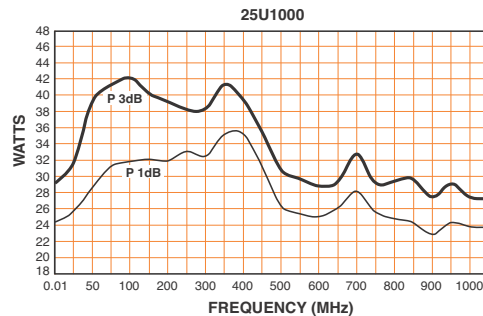

50U1000 10 kHz – 1000 MHz 50 W CW



Rated Output Power	70 W typ., 50 W min.
Input for Rated Output	1 milliwatt max.
Power Output	@ 3 dB compression Typ. 70 W / min. 50 W
Power Output	@ 1 dB compression Typ. 60 W / min. 45 W
Flatness	±1.5 dB typ., ±2 dB max.
Frequency Response	10 kHz – 1000 MHz instantaneously
Gain (at max. setting)	47 dB min.
Gain Adjustment (continuous range)	20 dB min.
Input Impedance	50 ohms, VSWR 2:1 max.
Output Impedance	50 ohms, nominal
Mismatch Tolerance	Will operate without damage or oscillation when connected to any load impedance without the aid of foldback circuitry.
Modulation Capability	Will faithfully reproduce AM, FM, or pulse modulation appearing on the input signal.
Third Order Intercept Point	57 dBm typ.
Noise Figure	8 dB typ.
Harmonic Distortion	Minus 20 dBc max. at 45 W
Spurious	Minus 73 dBc typ.
Primary Power (selected automatically)	100 – 240 VAC 50/60 Hz, 250 W

Connectors	RF Input RF Output	Type N female Type N female
Remotes Package	IEEE-488 RS-232 Fiber optic USB 2 Ethernet Safety Interlock	24-pin female 9-pin subminiature D (female) ST Conn Tx and Rx RS-232 Type B RJ-45 15-pin subminiature D
Cooling	Forced air (self-contained fans)	
Weight	With Cabinet Without Cabinet	17.7 kg (41 lb.) 9.5 kg (23 lb.)
Size (WxHxD)	With Cabinet Without Cabinet	50.3 x 15.5 x 55.1 cm / 19.8 x 6.1 x 21.7 in. 48.3 x 13.2 x 55.1 cm / 19 x 5.2 x 21.7 in.
Export classification	EAR99	

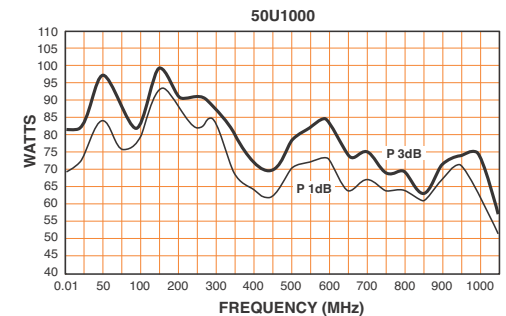

Universal Series Amplifiers

Frequency Range
10 kHz – 1000 MHz

Power Range
1 – 500 W

100U1000A 10 kHz – 1000 MHz 100 W CW



Rated Output Power	120 W typ., 100 W min.
Input for Rated Output	1 milliwatt max.
Power Output	@ 3 dB compression Typ. 120 W / min. 100 W
Power Output	@ 1 dB compression Typ. 100 W / min. 85 W
Flatness	±1.5 dB typ., ±2 dB max.
Frequency Response	100 kHz – 1000 MHz instantaneously
Gain (at max. setting)	50 dB min.
Gain Adjustment (continuous range)	20 dB min.
Input Impedance	50 ohms, VSWR 2:1 max.
Output Impedance	50 ohms, nominal
Mismatch Tolerance	Will operate without damage or oscillation when connected to any load impedance without the aid of foldback circuitry.
Modulation Capability	Will faithfully reproduce AM, FM, or pulse modulation appearing on the input signal.
Third Order Intercept Point	60 dBm typ.
Noise Figure	8.5 dB typ.
Harmonic Distortion	Minus 20 dBc max. at 100 W Minus 30 dBc typical at 100 W
Spurious	Minus 73 dBc typ.
Primary Power (selected automatically)	100 – 240 VAC 50/60 Hz, 700 W

Connectors	
RF Input	Type N female
RF Output	Type N female
Remotes Package	
IEEE-488	24-pin female
RS-232	9-pin subminiature D (female)
Fiber optic	ST Conn Tx and Rx RS-232
USB 2	Type B
Ethernet	RJ-45
Safety Interlock	15-pin subminiature D
Cooling Forced air (self-contained fans)	
Weight	
With Cabinet	35 kg (77 lb.)
Without Cabinet	24 kg (52 lb.)
Size (WxHxD)	
With Cabinet	50.3 x 20.5 x 74.9 cm / 19.8 x 8.1 x 29.5 in.
Without Cabinet	48.3 x 17.7 x 74.9 cm / 19 x 7 x 29.5 in.
Export classification EAR99	

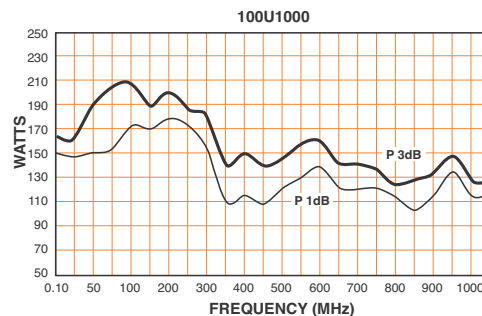

250U1000A 10 kHz – 1000 MHz 250 W CW



Rated Output Power	.01 – 250MHz: 300 W typical, 280 W minimum 250 – 700MHz: 300 W typical, 250 W minimum 700 – 1000 MHz: 225 W typical, 210 W minimum
Input for Rated Output	1 milliwatt max.
Power Output	@ 3 dB compression .01 – 250MHz: 300 W typical, 270 W minimum 250 – 700MHz: 300 W typical, 240 W minimum 700 – 1000 MHz: 225 W typical, 190 W minimum
Power Output	@ 1 dB compression .01 – 250MHz: 250 W typical, 240 W minimum 250 – 700MHz: 250 W typical, 200 W minimum 700 – 1000 MHz: 225 W typical, 175 W minimum
Flatness	±1.5 dB typ., ±2 dB max.
Frequency Response	10 kHz – 1000 MHz instantaneously
Gain (at max. setting)	54 dB min.
Gain Adjustment (continuous range)	20 dB min.
Input Impedance	50 ohms, VSWR 2:1 max.
Output Impedance	50 ohms, nominal
Mismatch Tolerance	Will operate without damage or oscillation when connected to any load impedance without the aid of foldback circuitry.
Modulation Capability	Will faithfully reproduce AM, FM, or pulse modulation appearing on the input signal.
Third Order Intercept Point	62 dBm typ.
Noise Figure	8.5 dB typ.

Harmonic Distortion	Minus 20 dBc max. at 200 W Minus 20 dBc typical at 250 W
Spurious	Minus 73 dBc typ.
Primary Power (selected automatically)	100 – 240 VAC 50/60 Hz, 1,150 W
Connectors	
RF Input	Type N female
RF Output	Type N female
Remotes Package	
IEEE-488	24-pin female
RS-232	9-pin subminiature D (female)
Fiber optic	ST Conn Tx and Rx RS-232
USB 2	Type B
Ethernet	RJ-45
Safety Interlock	15-pin subminiature D
Cooling Forced air (self-contained fans)	
Weight	
With Cabinet	58.9 kg (130 lb.)
Without Cabinet	46.2 kg (102 lb.)
Size (W x H x D): 19" 6U Rack:	
With cabinet:	50.3 x 28 x 74.9 cm (19.8 x 11.2 x 29.5 in)
Without Cabinet:	48.3 x 27.9 x 74.9 cm (19 x 11 x 29.5 in)
Export classification EAR99	

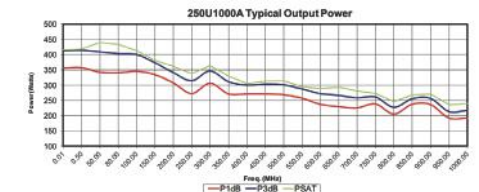

Universal Series Amplifiers

Frequency Range
10 kHz – 1000 MHz

Power Range
1 – 500 W

500U1000 100 kHz – 1000 MHz 500 W CW



Rated Output Power	0.1 – 350MHz: 650 watts typical, 500 watts min. 350 – 650MHz: 525 watts typical, 400 watts min. 650 – 1000 MHz: 400 watts typical, 325 watts min.
Input for Rated Output	1 mW Max
Power Output @ 3 dB compression	0.1 – 350MHz: 650 watts typical, 500 watts min. 350 – 650MHz: 500 watts typical, 375 watts min. 650 – 1000 MHz: 375 watts typical, 300 watts min.
Power Output @ 1 dB compression	0.1 – 350MHz: 550 watts typical, 400 watts min. 350 – 650MHz: 450 watts typical, 325 watts min. 650 – 1000 MHz: 350 watts typical, 275 watts min.
Flatness	±2.0 dB typical, ±2.5 dB maximum
Frequency Response	100 kHz – 1000 MHz instantaneously
Gain (at max. setting)	57 dB min.
Gain Adjustment (continuous range)	20 dB min.
Input Impedance	50 ohms, VSWR 2:0:1 max.
Output Impedance	50 ohms, nominal
Mismatch Tolerance	100% of rated power with-out foldback up to 6.0:1 mismatch above which may limit to 250 watts reflected power. Will operate with-out damage or oscillation with any magnitude and phase of source and load impedance.
Modulation Capability	Will faithfully reproduce AM, FM, or pulse modulation appearing on the input signal.
Third Order Intercept Point	65 dBm typ.
Noise Figure	8 dB typ.

Harmonic Distortion	<-20 dBc for the output power at 1dB compression minimum limit <-17 dBc for the output power at 3dB compression minimum limit
Spurious	Minus 73 dBc typ.
Primary Power (selected automatically)	200 – 240 VAC 50/60 Hz, 2100 W
Connectors	RF Input Type N female RF Output Type N female
Remotes Package	IEEE-488 24-pin female RS-232 9-pin subminiature D (female) Fiber optic ST Conn Tx and Rx RS-232 USB 2 Type B Ethernet RJ-45 Safety Interlock 15-pin subminiature D
Cooling	Forced air (self-contained fans)
Weight	With Cabinet 79.4 kg (175 lbs) Without Cabinet 60.8 kg (134 lbs)
Size (WxHxD)	With Cabinet 0.3 x 38.1 x 74.9 cm (19.8 x 15 x 29.5 in) Without Cabinet 48.3 x 35.6 x 74.9 cm (19 x 14.0 x 29.5 in)
Export classification	EAR99



Microwave Amplifiers



250S1G6C

AR's microwave amplifiers are denoted as the "S" Series amplifiers, covering the 0.7 - 18 GHz frequency range. These amplifiers operate in frequency bands including; 0.7 - 6 GHz, 1 - 2.5 GHz, and 6 to 18 GHz. Each band covers multiple power levels offering the highest available power for a specific frequency range. In addition to EMC testing, these amplifiers are particularly suited to Telecommunications testing requirements such power drivers for Digital Predistortion, High Temperature Operating Life and Production Burn-in Systems.



Microwave Amplifiers

Frequency Range
0.7 – 18 GHz

Power Range
15 – 1000 W

15S1G6 0.7 – 6 GHz 15 W CW



Rated Power Output	15 W min.
Input for Rated Output	1 milliwatt max.
Power Output	@ 3 dB compression Nominal 20 W / min. 15 W
Power Output	@ 1 dB compression Nominal 15 W / min. 12 W
Flatness	±1.5 dB typ. / ±2 dB max.
Frequency Response	0.7–6 GHz instantaneously
Gain (at max. setting)	43 dB min.
Gain Adjustment (continuous range)	10 dB min. (4096 steps remote)
Input Impedance	50 ohms, VSWR 2:1 max.
Output Impedance	50 ohms, nominal
Mismatch Tolerance*	Will operate without damage or oscillation when connected to any load impedance without the aid of foldback circuitry.
Modulation Capability	Will faithfully reproduce AM, FM, or pulse modulation appearing on the input signal.
Third Order Intercept Point	48 dBm typ.
Noise Figure	10 dB typ.
Harmonic Distortion	Minus 20 dBc max. at 15 W (1–6 GHz) Minus 20 dBc max. at 15 W (0.7–6 GHz)
Spurious	Minus 73 dBc typ.

Primary Power (selected automatically)	90 – 132, 180 – 264 VAC 50/60 Hz, single phase 210 W max.
Connectors	RF input Type N female on front panel RF output Type N female on front panel Standard Remote Interfaces Included
Remote Interfaces	IEEE-488 24-pin female RS-232 9-pin Subminiature D (female) RS-232 (fiber optic) Type ST USB Type B 2 Type B RJ-45 Ethernet
Safety Interlock	15-pin Subminiature D
Cooling	Forced air (self-contained fans)
Weight	With Cabinet 15.9 kg (35 lb.) Without Cabinet 10.2 kg (22.5 lb.)
Size (WxHxD)	With Cabinet 50.3 x 15.5 x 37.6 cm / 19.8 x 6.1 x 14.8 in. Without Cabinet 48.3 x 12.7 x 37.6 cm / 19 x 5 x 14.8 in.
Export Classification:	EAR99

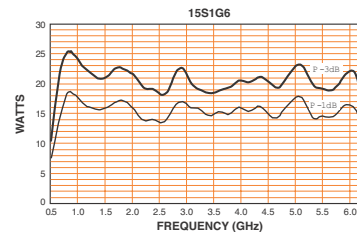

30S1G6 0.7 – 6 GHz 30 W CW



Rated Power Output	30 W min.
Input for Rated Output	1 milliwatt max.
Power Output	@ 3 dB compression Nominal 35 W / min. 26 W
Power Output	@ 1 dB compression Nominal 30 W / min. 22 W Small Signal Gain Flatness ±1.5 dB typ. / ±2 dB max.
Frequency Response	0.7–6 GHz instantaneously
Gain (at max. setting)	44 dB min.
Gain Adjustment (continuous range)	10 dB min. (4096 steps remote)
Input Impedance	50 ohms, VSWR 2:1 max.
Output Impedance	50 ohms, nominal
Mismatch Tolerance	Will operate without damage or oscillation when connected to any load impedance without the aid of foldback circuitry.
Modulation Capability	Will faithfully reproduce AM, FM, or pulse modulation appearing on the input signal.
Third Order Intercept Point	50 dBm typ.
Noise Figure	10 dB typ.
Harmonic Distortion	Minus 20 dBc max. at 30 W
Spurious	Minus 73 dBc typ.

Primary Power (selected automatically)	90–132, 180–264 VAC 50/60 Hz, single phase 300 W max.
Connectors	RF input Type N female on front panel RF output Type N female on front panel
Remote Interfaces	IEEE-488 24-pin female RS-232 9-pin Subminiature D (female) RS-232 (fiber optic) Type ST USB 2 Type B Ethernet RJ-45
Safety Interlock	15-pin Subminiature D
Cooling	Forced air (self-contained fans)
Weight	With Cabinet 18.2 kg (40 lb.) Without Cabinet 12.5 kg (27.5 lb.)
Size (WxHxD)	With Cabinet 50.3 x 15.5 x 37.6 cm / 19.8 x 6.1 x 14.8 in. Without Cabinet 48.3 x 12.7 x 37.6 cm / 19 x 5 x 14.8 in.
Export Classification:	EAR99

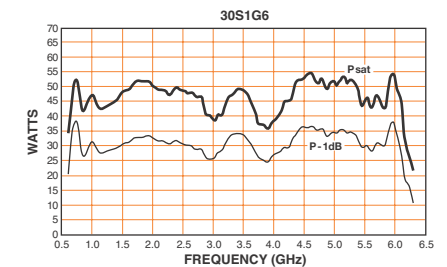

Microwave Amplifiers

Frequency Range
0.7 – 18 GHz

Power Range
15 – 1000 W

30S1G6C 1 – 6 GHz 30 W CW



Rated Power Output	30 W min.
Input for Rated Output	1 milliwatt max.
Power Output	@ 3 dB compression Nominal 45 W / min. 35 W
Power Output	@ 1 dB compression Nominal 35 W / min. 25 W
Small Signal Gain Flatness	±1.5 dB typ. / ±2 dB max.
Frequency Response	1.0 – 6 GHz instantaneously
Gain (at max. setting)	46 dB min.
Gain Adjustment (continuous range)	10 dB min.
Input Impedance	50 ohms, VSWR 2:1 max.
Output Impedance	50 ohms, nominal
Mismatch Tolerance	Will operate without damage or oscillation when connected to any load impedance without the aid of foldback circuitry.
Modulation Capability	Will faithfully reproduce AM, FM, or pulse modulation appearing on the input signal.
Third Order Intercept Point	54 dBm typ.
Noise Figure	10 dB typ.
Harmonic Distortion	Minus 20 dBc max. at 30 W
Spurious	Minus 73 dBc typ.

Primary Power (selected automatically)	100 – 240 VAC 47-63 Hz, single phase 400 W max.
Connectors	RF input Type N female RF output Type N female
Remote Interfaces	IEEE-488 24-pin female RS-232 9-pin Subminiature D (female) RS-232 (fiber optic) Type ST USB 2 Type B Ethernet RJ-45
Safety Interlock	15-pin Subminiature D
Cooling	Forced air (self-contained fans)
Weight	With Cabinet 18.2 kg (40 lb.) Without Cabinet 12.5 kg (27.5 lb.)
Size (WxHxD)	With Cabinet 51.0 x 17 x 65.3 cm / 20.1 x 6.7 x 25.7 in. Without Cabinet 48.3 x 13.4 x 65.3 cm / 19 x 5.3 x 14.8 in.
Export Classification:	EAR99

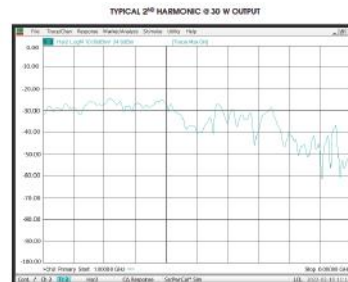

60S1G6 0.7 – 6 GHz 60 W CW



Rated Power Output	60 W min. (0.7–6 GHz)
Input for Rated Output	1 milliwatt max.
Power Output	@ 3 dB compression Nominal 80 W / min. 65 W
Power Output	@ 1 dB compression Nominal 60 W / min. 50 W
Flatness	±1.5 dB typ. / ±2.5 dB max.
Frequency Response	0.7–6 GHz instantaneously
Gain (at max. setting)	48 dB min.
Gain Adjustment (continuous range)	10 dB min. (4096 steps remote)
Input Impedance	50 ohms, VSWR 2:1 max.
Output Impedance	50 ohms, nominal
Mismatch Tolerance	Will operate without damage or oscillation when connected to any load impedance without the aid of foldback circuitry.
Modulation Capability	Will faithfully reproduce AM, FM, or pulse modulation appearing on the input signal.
Third Order Intercept Point	56 dBm typ.
Noise Figure	10 dB typ.
Harmonic Distortion	Minus 20 dBc max. at 60 W (0.7–6 GHz)
Spurious	Minus 73 dBc typ.
Phase Linearity	±1 deg/100 MHz, typ.

Primary Power (selected automatically)	90–132, 180–250 VAC 50/60 Hz, single phase 550 W max.
Connectors	RF Type N female on front panel
Remote Interfaces	IEEE-488 24-pin RS-232 9-pin Subminiature D RS-232 (fiber optic) Type ST USB 2 Type B Ethernet RJ-45
Safety Interlock	15-pin Subminiature D
Cooling	Forced air (self-contained fans)
Weight	With Cabinet 28.4 kg (62.5 lb.) Without Cabinet 20.2 kg (44.5 lb.)
Size (WxHxD)	With Cabinet 50.3 x 20.3 x 54.6 cm / 19.8 x 8 x 21.5 in. Without Cabinet 48.3 x 17.8 x 54.6 cm / 19 x 7 x 21.5 in.
Export Classification:	3A001

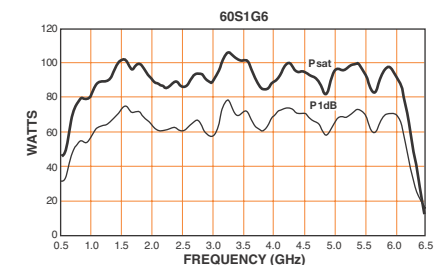

Product Catalog | 2023

For Sales, call: 215.723.8181

For an Applications Engineer, call: 800.933.8181

arworld.us

35

Contents

Find it Fast

RF Solid State

Universal Series

Microwave

Solid State Pulse

TWT

Systems

Antennas

Accessories

Contact

AR Companies

Microwave Amplifiers

Frequency Range
0.7 – 18 GHz

Power Range
15 – 1000 W

75S1G6C 1.0 – 6.0 GHz 75 W CW



Rated Power Output	75 W min. (0.7–6 GHz)
Input for Rated Output	1 milliwatt max.
Power Output	@ 3 dB compression Nominal 80 W / min. 65 W
Power Output	@ 1 dB compression Nominal 60 W / min. 50 W
Flatness	±1.5 dB typ. / ±2.5 dB max.
Frequency Response	0.7–6 GHz instantaneously
Gain (at max. setting)	48 dB min.
Gain Adjustment (continuous range)	10 dB min. (4096 steps remote)
Input Impedance	50 ohms, VSWR 2:1 max.
Output Impedance	50 ohms, nominal
Mismatch Tolerance	Will operate without damage or oscillation when connected to any load impedance without the aid of foldback circuitry.
Modulation Capability	Will faithfully reproduce AM, FM, or pulse modulation appearing on the input signal.
Third Order Intercept Point	56 dBm typ.
Noise Figure	10 dB typ.
Harmonic Distortion	Minus 20 dBc max. at 60 W (0.7–6 GHz)
Spurious	Minus 73 dBc typ.
Phase Linearity	±1 deg/100 MHz, typ.

Primary Power (selected automatically)	90–132, 180–250 VAC 50/60 Hz, single phase 550 W max.
Connectors	RF Type N female on front panel
Remote Interfaces	IEEE-488 24-pin RS-232 9-pin Subminiature D RS-232 (fiber optic) Type ST USB 2 Type B Ethernet RJ-45
Safety Interlock	15-pin Subminiature D
Cooling	Forced air (self-contained fans)
Weight	With Cabinet 28.4 kg (62.5 lb.) Without Cabinet 20.2 kg (44.5 lb.)
Size (WxHxD)	With Cabinet 50.3 x 20.3 x 54.6 cm / 19.8 x 8 x 21.5 in. Without Cabinet 48.3 x 17.8 x 54.6 cm / 19 x 7 x 21.5 in.
Export Classification:	3A001

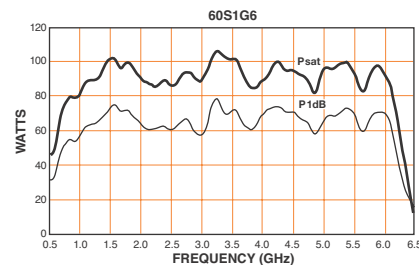

125S1G6 0.7 – 6 GHz 125 W CW



Rated Power Output	125 W min.
Input for Rated Output	1 milliwatt max.
Power Output	@ 3 dB compression Nominal 125 W / min. 120 W
Power Output	@ 1 dB compression Nominal 120 W / min. 100 W
Flatness	±1.5 dB typ. / ±2.5 dB max.
Frequency Response	0.7–6 GHz instantaneously
Gain (at max. setting)	52 dB min.
Gain Adjustment (continuous range)	10 dB min. (4096 steps remote)
Input Impedance	50 ohms, VSWR 2:1 max.
Output Impedance	50 ohms, nominal
Mismatch Tolerance	Will operate without damage or oscillation when connected to any load impedance without the aid of foldback circuitry.
Modulation Capability	Will faithfully reproduce AM, FM, or pulse modulation appearing on the input signal.
Third Order Intercept Point	58 dBm typ.
Noise Figure	10 dB typ.
Harmonic Distortion	Minus 20 dBc max. at 125 W (0.7–6 GHz)
Spurious	Minus 73 dBc typ.

Phase Linearity	±1 deg/100 MHz, typ.
Primary Power (selected automatically)	90–132, 180–264 VAC 50/60 Hz, single phase, 1,200 W max.
Connectors	RF Type N female on front panel
Remote Interfaces	IEEE-488 24-pin RS-232 9-pin Subminiature D RS-232 (fiber optic) Type ST USB 2 Type B Ethernet RJ-45
Safety Interlock	15-pin Subminiature D
Cooling	Forced air (self-contained fans)
Weight	With Cabinet 45 kg (100 lb.) Without Cabinet 34.5 kg (76 lb.)
Size (WxHxD)	With Cabinet 50.3 x 30 x 61 cm / 19.8 x 11.8 x 24 in. Without Cabinet 48.3 x 26.7 x 61 cm / 19 x 10.5 x 24 in.
Export Classification:	3A001

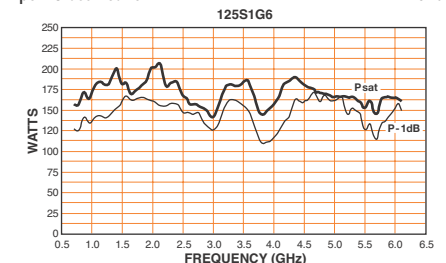

Microwave Amplifiers

Frequency Range
0.7 – 18 GHz

Power Range
15 – 1000 W



125S1G6C

1.0 – 6 GHz
125 W CW

Rated Power Output	125 W min.
Input for Rated Output	1 milliwatt max.
Power Output	@ 3 dB compression Nominal 125 W / min. 120 W
Power Output	@ 1 dB compression Nominal 115 W / min. 100 W
Flatness	±1.5 dB typ. / ±2.5 dB max.
Frequency Response	1.0–6 GHz instantaneously
Gain (at max. setting)	55 dB min.
Gain Adjustment (continuous range)	10 dB min. (4096 steps remote)
Input Impedance	50 ohms, VSWR 2:1 max.
Output Impedance	50 ohms, nominal
Mismatch Tolerance	Will operate without damage or oscillation when connected to any load impedance without the aid of foldback circuitry.
Modulation Capability	Will faithfully reproduce AM, FM, or pulse modulation appearing on the input signal.
Third Order Intercept Point	58 dBm typ.
Noise Figure	10 dB typ.
Harmonic Distortion	Minus 20 dBc max. at 125 W (1.0–6 GHz)
Spurious	Minus 73 dBc typ.

Primary Power (selected automatically)	100-240 VAC 47-63 Hz, single phase, 1,100 W max.
Connectors	RF Type N female
Remote Interfaces	IEEE-488 24-pin RS-232 9-pin Subminiature RS-232 (fiber optic) Type ST USB 2 Type B Ethernet RJ-45
Safety Interlock	15-pin Subminiature D
Cooling	Forced air (self-contained fans)
Weight	With Cabinet 39.5 kg (65 lb.) Without Cabinet 22.7 kg (50 lb.)
Size (WxHxD)	With Cabinet 50.3 x 35.5 x 65.3 cm / 19.8 x 14.0 x 25.7 in. Without Cabinet 48.3 x 35.5 x 65.3 cm / 19 x 14.0 x 25.7 in.
Export Classification:	3A001

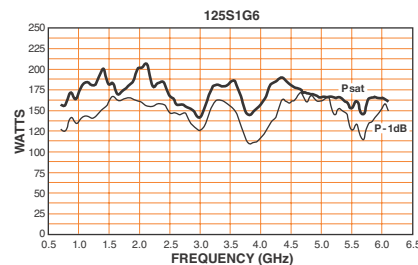

250S1G6

0.7 – 6 GHz
250 W CW



Rated Power Output	250 W min.
Input for Rated Output	1 milliwatt max.
Power Output	@ 3 dB compression Nominal 250 W / min. 225 W
Power Output	@ 1 dB compression Nominal 220 W / min. 200 W
Flatness	±1.5 dB typ. / ±2.5 dB max.
Frequency Response	0.7–6 GHz instantaneously
Gain (at max. setting)	54 dB min.
Gain Adjustment (continuous range)	10 dB min. (4096 steps remote)
Input Impedance	50 ohms, VSWR 2:1 max.
Output Impedance	50 ohms, nominal
Mismatch Tolerance	Will operate without damage or oscillation when connected to any load impedance without the aid of foldback circuitry.
Modulation Capability	Will faithfully reproduce AM, FM, or pulse modulation appearing on the input signal.
Third Order Intercept Point	60 dBm typ.
Noise Figure	10 dB typ.
Harmonic Distortion	Minus 20 dBc max. at 250 W (0.75–6 GHz); 18 dBc typ. (0.7–0.75 GHz)
Spurious	Minus 73 dBc typ.

Phase Linearity	±1 deg/100 MHz, typ.
Primary Power (selected automatically)	200–250 VAC 50/60 Hz, single phase 2,500 W max.
Connectors	RF Type N female on front panel
Remote Interfaces	IEEE-488 24-pin RS-232 9-pin Subminiature RS-232 (fiber optic) Type ST USB 2 Type B Ethernet RJ-45
Safety Interlock	15-pin Subminiature D
Cooling	Forced air (self-contained fans)
Weight	With Cabinet 64 kg (140 lb.) Without Cabinet 12.5 kg (27.5 lb.)
Size (WxHxD)	With Cabinet 50.3 x 47 x 61 cm / 19.8 x 18.5 x 24 in. Without Cabinet 48.3 x 44.3 x 58.5 cm / 19 x 17.3 x 23 in.
Export Classification:	3A001

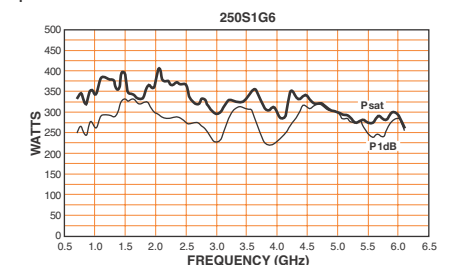

Microwave Amplifiers

Frequency Range
0.7 – 18 GHz

Power Range
15 – 1000 W

250S1G6C

1 – 6 GHz
250 W CW



Rated Power Output	250 W min.
Input for Rated Output	1 milliwatt max.
Power Output	@ 3 dB compression Nominal 225 W / min. 325 W
Power Output	@ 1 dB compression Nominal 275 W / min. 250 W
Flatness	±1.5 dB typ. / ±2.5 dB max.
Frequency Response	1.0 – 6 GHz instantaneously
Gain (at max. setting)	58 dB min.
Gain Adjustment (continuous range)	10 dB min. (4096 steps remote)
Input Impedance	50 ohms, VSWR 2:1 max.
Output Impedance	50 ohms, nominal
Mismatch Tolerance	Will operate without damage or oscillation when connected to any load impedance without the aid of foldback circuitry.
Modulation Capability	Will faithfully reproduce AM, FM, or pulse modulation appearing on the input signal.
Third Order Intercept Point	60 dBm typ.
Noise Figure	10 dB typ.
Harmonic Distortion	Entire Band at 200 W except 2-3 GHz; minus 20 dBc max 2-3 GHz; minus 18 dBc max
Spurious	Minus 73 dBc typ.

Primary Power (selected automatically)	100 – 240 VAC 47 – 63 Hz, single phase 1,750 W max.
Connectors	RF Type N female
Remote Interfaces	IEEE-488 24-pin RS-232 9-pin Subminiature RS-232 (fiber optic) Type ST USB 2 Type B Ethernet RJ-45
Safety Interlock	15-pin Subminiature D
Cooling	Forced air (self-contained fans)
Weight	With Cabinet 58. kg (129 lb.) Without Cabinet 44.9 kg (99 lb.)
Size (WxHxD)	With Cabinet 50.3 x 47 x 65.3 cm / 19.8 x 18.5 x 25.7 in. Without Cabinet 48.3 x 44.5 x 65.3 cm / 19 x 17.5 x 25.7 in.
Export Classification:	3A001

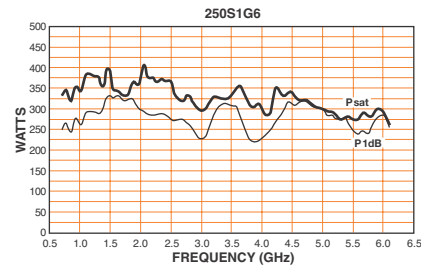

350S1G6A

0.7 – 6 GHz
350 W CW



Rated Power Output	350 W min.
Input for Rated Output	1 milliwatt max.
Power Output	@ 3 dB compression Nominal 370 W / min. 315 W
Power Output	@ 1 dB compression Nominal 300 W / min. 250 W
Flatness	±1.5 dB typ. / ±2.5 dB max.
Frequency Response	0.7–6 GHz instantaneously
Gain (at max. setting)	56 dB min.
Gain Adjustment (continuous range)	10 dB min. (4096 steps remote)
Input Impedance	50 ohms, VSWR 2:1 max.
Output Impedance	50 ohms, nominal
Mismatch Tolerance	Will operate without damage or oscillation when connected to any load impedance without the aid of foldback circuitry. However, mismatch above 6:1 may limit output to 175 W reflected power.
Modulation Capability	Will faithfully reproduce AM, FM, or pulse modulation appearing on the input signal.
Third Order Intercept Point	58 dBm typ.
Harmonic Distortion	Minus 20 dBc maximum at 300 W (1–6 GHz); Minus 20 dBc typical at 300 W (0.7–1 GHz).

Primary Power (selected automatically)	200–260 VAC 50/60 Hz, single phase 3,600 W max.
Connectors	RF input Type N female on rear panel RF output Type 7–16 DIN female on rear panel
Safety Interlock	15-pin female subminiature D, rear
Remote computer interface	IEEE-488 (GPIB) and RS-232 connector, rear
Remote Computer Interface (Fiber Optic)	ST Conn Tx, RS-232 Rx
USB 2	Type B
Ethernet	RJ-45
Cooling	Forced air (self-contained fans)
Weight	136 kg (300 lb.)
Size (WxHxD)	50.3 x 127 x 61 cm / 19.8 x 50 x 24 in.
Export Classification:	3A001

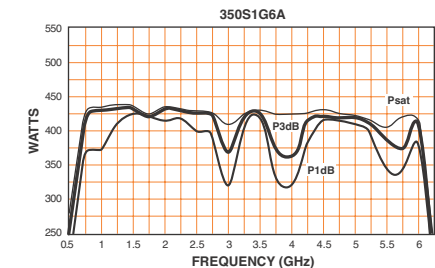

Microwave Amplifiers

Frequency Range
0.7 – 18 GHz

Power Range
15 – 1000 W

500S1G6A 0.7 – 6 GHz 500 W CW



Rated Power Output	500 W min.
Input for Rated Output	1 milliwatt max.
Power Output	@ 3 dB compression Nominal 525 W / min. 475 W
Power Output	@ 1 dB compression Nominal 450 W / min. 400 W
Flatness	±1.5 dB typ. / ±2.5 dB max.
Frequency Response	0.7–6 GHz instantaneously
Gain (at max. setting)	57 dB min.
Gain Adjustment (continuous range)	10 dB min.
Input Impedance	50 ohms, VSWR 2:1 max.
Output Impedance	50 ohms, nominal
Mismatch Tolerance	Will operate without damage or oscillation when connected to any load impedance without the aid of foldback circuitry. However, mismatch above 6:1 may limit output to 250 W reflected power.
Modulation Capability	Will faithfully reproduce AM, FM, or pulse modulation appearing on the input signal.
Third Order Intercept Point	63 dBm typ.
Harmonic Distortion	Minus 20 dBc max. at 400 W (1–6 GHz); Minus 20 dBc typ. at 400 W (0.7–1 GHz)
Primary Power (selected automatically)	200–260 VAC 50/60 Hz, single phase 3,800 W

Connectors	RF Input Type N female on rear panel RF Output Type 7–16 DIN female on rear panel
Remote Interfaces	IEEE–488 (GPIB) and RS–232 connector, rear ST Conn Tx, RS–232 Rx (fiber optic) USB 2 Type B Ethernet RJ–45
Safety Interlock	15–pin Subminiature D, rear IEEE–488 (GPIB) Interface and RS–232 Allows control and monitoring of all front panel controls except keylock position control
Cooling	Forced air (self–contained fans)
Weight	136 kg (300 lb.)
Size (WxHxD)	50.3 x 127 x 61 cm / 19.8 x 50 x 24 in.
Export Classification:	3A001

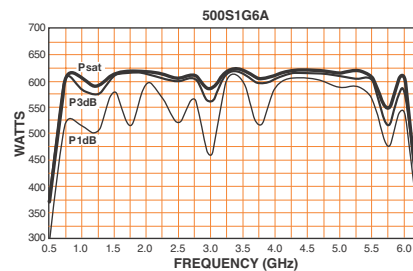

500S1G6C 1 – 6 GHz 500 W CW



Rated Power Output	500 W min.
Input for Rated Output	1 milliwatt max.
Power Output	@ 3 dB compression Nominal 525 W / min. 475 W
Power Output	@ 1 dB compression Nominal 450 W / min. 400 W
Flatness	±1.5 dB typ. / ±2.5 dB max.
Frequency Response	1 – 6 GHz instantaneously
Gain (at max. setting)	57 dB min.
Gain Adjustment (continuous range)	10 dB min.
Input Impedance	50 ohms, VSWR 2:1 max.
Output Impedance	50 ohms, nominal
Mismatch Tolerance	Will operate without damage or oscillation when connected to any load impedance without the aid of foldback circuitry. However, mismatch above 6:1 may limit output to 250 W reflected power.
Modulation Capability	Will faithfully reproduce AM, FM, or pulse modulation appearing on the input signal.
Third Order Intercept Point	63 dBm typ.
Harmonic Distortion	Minus 20 dBc max. at 500 W (1 – 6 GHz); Minus 18 dBc typ. at 500 W (2 – 3 GHz)
Primary Power (selected automatically)	200 – 260 VAC 50/60 Hz, single phase 3,800 W

Connectors	RF Input Type N female on rear panel RF Output Type 7–16 DIN female on rear panel
Remote Interfaces	IEEE–488 (GPIB) and RS–232 connector, rear ST Conn Tx, RS–232 Rx (fiber optic) USB 2 Type B Ethernet RJ–45
Safety Interlock	15–pin Subminiature D, rear IEEE–488 (GPIB) Interface and RS–232 Allows control and monitoring of all front panel controls except keylock position control
Cooling	Forced air (self–contained fans)
Weight	136 kg (300 lb.)
Size (WxHxD)	50.3 x 127 x 61 cm / 19.8 x 50 x 24 in.
Export Classification:	3A001

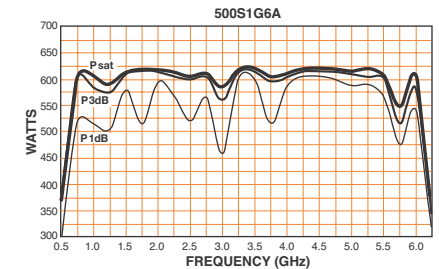

Microwave Amplifiers

Frequency Range
0.7 – 18 GHz

Power Range
15 – 1000 W

750S1G6C

1 – 6 GHz
750 W CW



Rated Power Output	750 W min.
Input for Rated Output	1 milliwatt max.
Power Output	@ 3 dB compression 1 – 4.2 GHz; Nominal 750 W 4.2 – 6 GHz; Nominal 550 W
Power Output	@ 1 dB compression 1 – 4.2 GHz; Nominal 600 W 4.2 – 6 GHz; Nominal 450 W
Flatness	±1.5 dB typ. / ±2.5 dB max.
Frequency Response	1 – 6 GHz instantaneously
Gain (at max. setting)	59 dB min.
Gain Adjustment (continuous range)	10 dB min.
Input Impedance	50 ohms, VSWR 2:1 max.
Output Impedance	50 ohms, nominal
Mismatch Tolerance	Will operate without damage or oscillation when connected to any load impedance without the aid of foldback circuitry. However, mismatch above 3:1 may limit output to 200 W reflected power.
Modulation Capability	Will faithfully reproduce AM, FM, or pulse modulation appearing on the input signal.
Third Order Intercept Point	67 dBm typ.
Harmonic Distortion	Minus 20 dBc max. at 600 W (1–6 GHz); Minus 18 dBc typ. at 600 W (2–3 GHz)
Primary Power (selected automatically)	200 – 260 VAC 50/60 Hz, single phase 3,800 W

Connectors	RF Input Type N female on rear panel RF Output Type 7–16 DIN female on rear panel
Remote Interfaces	IEEE-488 (GPIB) and RS-232 connector, rear ST Conn Tx, RS-232 Rx (fiber optic) USB 2 Type B Ethernet RJ-45
Safety Interlock	15-pin Subminiature D, rear
IEEE-488 (GPIB) Interface and RS-232	Allows control and monitoring of all front panel controls except keylock position control
Cooling	Forced air (self-contained fans)
Weight	203 kg (448 lb.)
Size (WxHxD)	57.3 x 136.0 x 67.1 cm / 22.6 x 53.5 x 26.5 in.
Export Classification:	3A001

30/2051G188 TYPICAL POWER OUTPUT WITH 0.7-6.0GHz BAND SELECTED

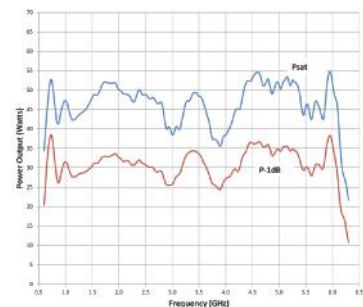

1000S1G6C

1 – 6 GHz
1,000 W CW



Rated Power Output	1,000 W min.
Input for Rated Output	1 milliwatt max.
Power Output	@ 3 dB compression 1 – 5 GHz; Nominal 1,000 W / min. 900 W 5 – 6 GHz; Nominal 800 W / min. 600 W
Power Output	@ 1 dB compression 1 – 5 GHz; Nominal 850 W / min. 750 W 5 – 6 GHz; Nominal 650 W / min. 550 W
Flatness	±1.5 dB typ. / ±2.5 dB max.
Frequency Response	1 – 6 GHz instantaneously
Gain (at max. setting)	64 dB min.
Gain Adjustment (continuous range)	10 dB min.
Input Impedance	50 ohms, VSWR 2:1 max.
Output Impedance	50 ohms, nominal
Mismatch Tolerance	Will operate without damage or oscillation when connected to any load impedance without the aid of foldback circuitry. However, mismatch above 6:1 may limit output to 250 W reflected power.
Modulation Capability	Will faithfully reproduce AM, FM, or pulse modulation appearing on the input signal.
Third Order Intercept Point	68 dBm typ.
Harmonic Distortion	Minus 20 dBc max. at 800 W (1–6 GHz); Minus 18 dBc typ. at 800 W (2–3 GHz)
Primary Power	200 – 240 VAC
Low Voltage Version	

High Voltage Version	47-63 Hz, single phase 8,500 W 380 – 415 VAC 47-63 Hz 8,500 W
Connectors	RF Input Type N female on rear panel RF Output Type 7–16 DIN female on rear panel
Remote Interfaces	IEEE-488 (GPIB) and RS-232 connector, rear ST Conn Tx, RS-232 Rx (fiber optic) USB 2 Type B Ethernet RJ-45 RF Sample Type N
Safety Interlock	15-pin Subminiature D, rear
IEEE-488 (GPIB) Interface and RS-232	Allows control and monitoring of all front panel controls except keylock position control
Cooling	Forced air (self-contained fans)
Weight	273 kg (600 lb.)
Size (WxHxD)	57.3 x 136 x 95.5 cm / 22.6 x 53.5 x 37.6 in.
Export Classification:	3A001

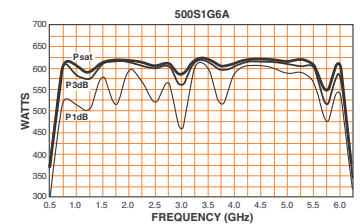

Microwave Amplifiers

Frequency Range
0.7 – 18 GHz

Power Range
15 – 1000 W

2000S1G2z8 1 – 2.8 GHz 2000 W CW



Rated Power Output	2,000 W min.
Input for Rated Output	1 milliwatt max.
Power Output	@ 3 dB compression 1 – 2.8 GHz; Nominal 2,400 W / min. 1,800 W
Power Output	@ 1 dB compression 1 – 2.8 GHz; Nominal 1,800 W / min. 1,500 W
Flatness	±1.5 dB typ. / ±2.5 dB max.
Frequency Response	1 – 2.8 GHz instantaneously
Gain (at max. setting)	67 dB min.
Gain Adjustment (continuous range)	10 dB min.
Input Impedance	50 ohms, VSWR 2:1 max.
Output Impedance	50 ohms, nominal
Mismatch Tolerance	Will operate without damage or oscillation when connected to any load impedance without the aid of foldback circuitry. However, mismatch above 6:1 may limit output to 1,000 W reflected power.
Modulation Capability	Will faithfully reproduce AM, FM, or pulse modulation appearing on the input signal.
Third Order Intercept Point	70 dBm typ.
Harmonic Distortion	Minus 20 dBc max. at 1,500 W
Primary Power	
Low Voltage Version	200 – 240 VAC

High Voltage Version	47 – 63 Hz, single phase 8,500 W 380 – 415 VAC 47 – 63 Hz 8,500 W
Connectors	RF Input Type N female on rear panel RF Output Type 7–16 DIN female on rear panel
Remote Interfaces	IEEE-488 (GPIB) and RS-232 connector, rear ST Conn Tx, RS-232 Rx (fiber optic) USB 2 Type B Ethernet RJ-45 RF Sample Type N
Safety Interlock	15-pin Subminiature D, rear
IEEE-488 (GPIB) Interface and RS-232	Allows control and monitoring of all front panel controls except keylock position control
Cooling	Forced air (self-contained fans)
Weight	363 kg (800 lb.)
Size (WxHxD)	57.3 x 193.8 x 103.1 cm / 22.6 x 76.3 x 40.6 in.
Export Classification:	3A001



125S1G2z5 1 – 2.5 GHz 125 W CW

Rated Power Output	140 W typ., 125 W min.
Input for Rated Output	1 milliwatt max.
Power Output	@ 3 dB compression Typ. 130 W, min. 115 W
Power Output	@ 1 dB compression Typ. 110 W, min. 90 W
Flatness	±1.5 dB typ. / ±2 dB max.
Frequency Response	1 – 2.5 GHz instantaneously
Gain (at max. setting)	54 dB min.
Gain Adjustment (continuous range)	20 dB min.
Input Impedance	50 ohms, VSWR 2:1 max.
Output Impedance	50 ohms, nominal
Mismatch Tolerance	Will operate without damage or oscillation when connected to any load impedance without the aid of foldback circuitry.
Modulation Capability	Will faithfully reproduce AM, FM, or pulse modulation appearing on the input signal.
Third Order Intercept Point	60 dBm typ.
Noise Figure	12 dB max.; 10 dB typ.
Harmonic Distortion	Minus 20 dBc max. at 100 W Minus 30 dBc typ. at 100 W
Spurious	Minus 73 dBc typ.
Primary Power (selected automatically)	100 – 240 VAC 50/60 Hz 650 W



Connectors	RF input Type N female RF output Type N female
Remote Interfaces	IEEE-488 24-pin female RS-232 9-pin Subminiature D (female) Fiber optic: ST Conn Tx and Rx RS-232 USB 2 Type B Ethernet RJ-45 Safety Interlock 15-pin Subminiature D
Cooling	Forced air (self-contained fans)
Acoustical Noise @ 1 Meter	Front: 60 dBA Side: 59 dBA Rear: 66 dBA
Weight	With Cabinet 36.7 kg (81 lb.) Without Cabinet 25.4 kg (56 lb.)
Size (WxHxD)	With cabinet 50.3 x 20.5 x 74.9 cm / 19.8 x 8.1 x 29.5 in. Without Cabinet 48.3 x 17.7 x 74.9 cm / 19 x 7 x 29.5 in.
Environmental	Storage Temperature -20°C/+50°C
Export Classification:	EAR99

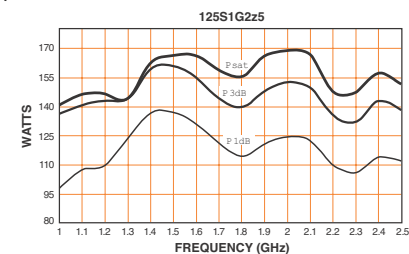

Microwave Amplifiers

Frequency Range
0.7 – 18 GHz

Power Range
15 – 1000 W

250S1G2z5B

1 – 2.5 GHz
250 W CW



Rated Power Output	300 W typ., 250 W min.
Input for Rated Output	1 milliwatt max.
Power Output	@ 3 dB compression Typ. 275 W, min. 250 W
Power Output	@ 1 dB compression Typ. 225 W, min. 200 W
Flatness	±1.5 dB typ. / ±2 dB max.
Frequency Response	1 – 2.5 GHz instantaneously
Gain (at max. setting)	56 dB min.
Gain Adjustment (continuous range)	20 dB min.
Input Impedance	50 ohms, VSWR 2:1 max.
Output Impedance	50 ohms, nominal
Mismatch Tolerance	Will operate without damage or oscillation when connected to any load impedance without the aid of foldback circuitry.
Modulation Capability	Will faithfully reproduce AM, FM, or pulse modulation appearing on the input signal.
Third Order Intercept Point	62 dBm typ.
Noise Figure	12 dB max.; 10 dB typ.
Harmonic Distortion	Minus 20 dBc max. at 200 W Minus 30 dBc typ. at 200 W
Spurious	Minus 73 dBc typ.
Primary Power (selected automatically)	100 – 240 VAC 50/60 Hz, single phase 1,200 W max.

Connectors	RF input RF output	Type N female on front panel Type N female on front panel
Remote Interfaces	IEEE-488 RS-232 Fiber optic: USB 2 Ethernet	24-pin female 9-pin Subminiature D (female) ST Conn Tx and Rx RS-232 Type B RJ-45
Safety Interlock		15-pin Subminiature D
Cooling		Forced air (self-contained fans)
Weight	With Cabinet Without Cabinet	42.6 kg (94 lb.) 31.3 kg (69 lb.)
Size (WxHxD)	With cabinet Without Cabinet	50.3 x 20.5 x 74.9 cm / 19.8 x 8.1 x 29.5 in. 48.3 x 17.7 x 74.9 cm / 19 x 7 x 29.5 in.
Export Classification:		EAR99

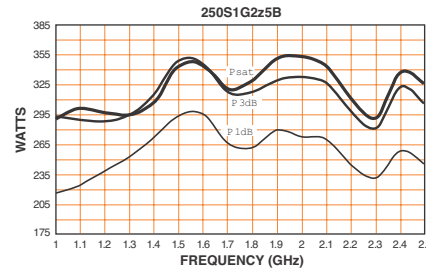

500S1G2z5A

1 – 2.5 GHz
500 W CW



Rated Power Output	550 W nominal, 500 W min.
Input for Rated Output	1 milliwatt max.
Power Output	@ 3 dB compression Nominal 550 W / min. 450 W
Power Output	@ 1 dB compression Nominal 400 W / min. 350 W
Flatness	±1.5 dB typ. / ±2 dB max. ±0.5 dB typ. with internal leveling
Frequency Response	1 – 2.5 GHz instantaneously
Gain (at max. setting)	57 dB min.
Gain Adjustment (continuous range)	20 dB min. (4096 steps remote)
Input Impedance	50 ohms, VSWR 2:1 max.
Output Impedance	50 ohms, nominal
Mismatch Tolerance	Will operate without damage or oscillation when connected to any load impedance without the aid of foldback circuitry.
Modulation Capability	Will faithfully reproduce AM, FM, or pulse modulation appearing on the input signal.
Third Order Intercept Point	66 dBm typ.
Noise Figure	10 dB typ.
Harmonic Distortion	Minus 20 dBc max. at 350 W Minus 20 dBc typ. at 500 W
Spurious	Minus 73 dBc typ.
Phase Linearity	±1 deg/100 MHz, typ.

Primary Power (selected automatically)	100 – 240 VAC 50/60 Hz 2,250 W max.	
Connectors	RF input RF output	Type N female Type 7/16 female
Remote Interfaces	IEEE-488 RS-232 Fiber Optic USB 2 Ethernet	24-pin female 9-pin Subminiature D (female) ST Conn Tx and Rx RS-232 Type B RJ-45
Safety Interlock		15-pin Subminiature D
Cooling		Forced air (self-contained fans)
Acoustical Noise @ 1 Meter		Front: 56 dBA Side: 57 dBA Rear: 64 dBA
Weight	With Cabinet Without Cabinet	64.9 kg (143 lb.) 50.3 kg (111 lb.)
Size (WxHxD)	With cabinet: Without Cabinet:	50.3 x 38.1 x 74.9 cm (19.8 x 15 x 29.5 in.) 48.3 x 35.6 x 74.9 cm (19 x 14 x 29.5 in.)
Environmental		Storage Temperature -20°C/+50°C
Export Classification:		EAR99

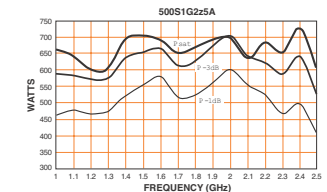

Microwave Amplifiers

Frequency Range
0.7 – 18 GHz

Power Range
15 – 1000 W

1000S1G2z5B

1 – 2.5 GHz
1000 W CW



Rated Power Output	1000 W min.
Input for Rated Output (0 dBm)	1 milliwatt max.
Power Output	@ 3 dB compression Nominal 1000 W / min. 925 W
Power Output	@ 1 dB compression Nominal 850 W / min. 725 W
Flatness	±1.5 dB typ. / ±2 dB max.
Frequency Response	1 – 2.5 GHz instantaneously
Gain (at max. setting)	60 dB min.
Gain Adjustment (continuous range)	20 dB min. (4096 steps remote)
Input Impedance	50 ohms, VSWR 2:1 max.
Output Impedance	50 ohms, nominal
Mismatch Tolerance	Will operate without damage or oscillation when connected to any load impedance without the aid of foldback circuitry.
Modulation Capability	Will faithfully reproduce AM, FM, or pulse modulation appearing on the input signal.
Third Order Intercept Point	69 dBm typ.
Noise Figure	10 dB typ.
Harmonic Distortion	Minus 20 dBc max. at 800 W Minus 20 dBc typ. at 1000 W
Spurious	Minus 73 dBc typ.
Primary Power (selected automatically)	200 – 240 VAC 50/60 Hz, single phase 4,200 W max.

Connectors	RF input Type N female on rear panel RF output Type 7/8 EIA female on rear panel
Remote Interfaces	IEEE-488 24-pin female RS-232 9-pin Subminiature D (female) RS-232 (fiber optic) Type ST USB 2 Type B Ethernet RJ-45
Safety Interlock	15-pin Subminiature D
Cooling	Forced air (self-contained fans)
Acoustical Noise @ 1 Meter	Front: 44 dBA Side: 68 dBA Rear: 72 dBA
Weight	131.5 kg (290 lb.)
Size (WxHxD)	56.1 x 97.8 x 82.5 cm / 22.1 x 38.5 x 32.5 in.
Environmental	Storage Temperature -20°C/+50°C
Export Classification:	EAR99

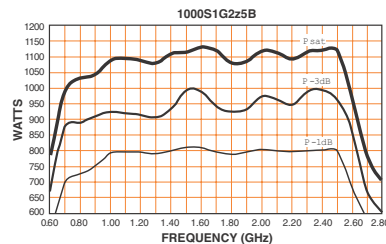

20S6G18C

6 – 18 GHz
20 W CW

Rated Power Output	20 W min.
Input for Rated Output	1 milliwatt max., 0 dBm
Power Output	@ 3 dB compression Nominal 25 W / min. 18 W
Power Output	@ 1 dB compression Nominal 22 W / min. 15 W
Power Gain Flatness (0 dBm IN)	±2 dB typ. / ±2.5 dB max.
Frequency Response	6 – 18 GHz instantaneously
Gain (at max. setting)	45 dB min.
Gain Adjustment (continuous range)	10 dB min.
Input Impedance	50 ohms, VSWR 2.5:1 max.
Output Impedance	50 ohms, nominal
Mismatch Tolerance	Will operate without damage or oscillation when connected to any load impedance without the aid of foldback circuitry.
Modulation Capability	Will faithfully reproduce AM, FM, or pulse modulation appearing on the input signal.
Third Order Intercept Point	49 dBm typ.
Harmonic Distortion	Minus 20 dBc max. at 25 W
Primary Power (selected automatically)	47 - 63, 100 - 240 VAC 50/60 Hz, single phase <700 W max.
Connectors	RF input Precision N female on front panel RF output Precision N female on front panel



Remote Interfaces	IEEE-488 24-pin female RS-232 9-pin Subminiature D (female) RS-232 (fiber optic) Type ST USB 2 Type B Ethernet RJ-45
Safety Interlock	15-pin Subminiature D
Cooling Weight	Forced air w/cabinet: 29.5 (65 lb.) w/o cabinet: 20.4 kg (45 lb.)
Size (WxHxD)	w/cabinet: 50.2 x 20.6 x 63.8 cm (19.8 x 8.1 x 25.1 in.) w/o cabinet: 48.3 x 18.8 x 63.8 cm (19 x 7 x 25.1 in.)
Export Classification:	3A001

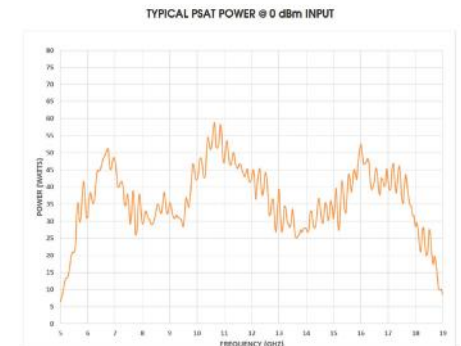

Microwave Amplifiers

Frequency Range
0.7 – 18 GHz

Power Range
15 – 1000 W

40S6G18C 6 – 18 GHz 40 W CW



Rated Power Output	20 W min.
Input for Rated Output	1 milliwatt max., 0 dBm
Power Output	@ 3 dB compression Nominal 25 W / min. 18 W
Power Output	@ 1 dB compression Nominal 22 W / min. 15 W
Power Gain Flatness (0 dBm IN)	±2 dB typ. / ±2.5 dB max.
Frequency Response	6 – 18 GHz instantaneously
Gain (at max. setting)	45 dB min.
Gain Adjustment (continuous range)	10 dB min.
Input Impedance	50 ohms, VSWR 2.5:1 max.
Output Impedance	50 ohms, nominal
Mismatch Tolerance	Will operate without damage or oscillation when connected to any load impedance without the aid of foldback circuitry.
Modulation Capability	Will faithfully reproduce AM, FM, or pulse modulation appearing on the input signal.
Third Order Intercept Point	49 dBm typ.
Harmonic Distortion	Minus 20 dBc max. at 25 W
Primary Power (selected automatically)	47 - 63, 100 - 240 VAC 50/60 Hz, single phase <700 W max.
Connectors	RF input Precision N female on front panel RF output Precision N female on front panel

Remote Interfaces	IEEE-488 24-pin female RS-232 9-pin Subminiature D (female) RS-232 (fiber optic) Type ST USB 2 Type B Ethernet RJ-45
Safety Interlock	15-pin Subminiature D
Cooling Weight	Forced air w/cabinet: 29.5 (65 lb.) w/o cabinet: 20.4 kg (45 lb.)
Size (WxHxD)	w/cabinet: 50.2 x 20.6 x 63.8 cm (19.8 x 8.1 x 25.1 in.) w/o cabinet: 48.3 x 18.8 x 63.8 cm (19 x 7 x 25.1 in.)
Export Classification:	3A001

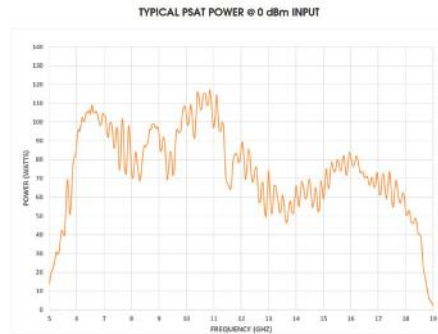

75S6G18C 6 – 18 GHz 75 W CW



Rated Power Output	20 W min.
Input for Rated Output	1 milliwatt max., 0 dBm
Power Output	@ 3 dB compression Nominal 25 W / min. 18 W
Power Output	@ 1 dB compression Nominal 22 W / min. 15 W
Power Gain Flatness (0 dBm IN)	±2 dB typ. / ±2.5 dB max.
Frequency Response	6 – 18 GHz instantaneously
Gain (at max. setting)	45 dB min.
Gain Adjustment (continuous range)	10 dB min.
Input Impedance	50 ohms, VSWR 2.5:1 max.
Output Impedance	50 ohms, nominal
Mismatch Tolerance	Will operate without damage or oscillation when connected to any load impedance without the aid of foldback circuitry.
Modulation Capability	Will faithfully reproduce AM, FM, or pulse modulation appearing on the input signal.
Third Order Intercept Point	49 dBm typ.
Harmonic Distortion	Minus 20 dBc max. at 25 W
Primary Power (selected automatically)	47 - 63, 100 - 240 VAC 50/60 Hz, single phase <700 W max.
Connectors	RF input Precision N female on front panel RF output Precision N female on front panel

Remote Interfaces	IEEE-488 24-pin female RS-232 9-pin Subminiature D (female) RS-232 (fiber optic) Type ST USB 2 Type B Ethernet RJ-45
Safety Interlock	15-pin Subminiature D
Cooling Weight	Forced air w/cabinet: 29.5 (65 lb.) w/o cabinet: 20.4 kg (45 lb.)
Size (WxHxD)	w/cabinet: 50.2 x 20.6 x 63.8 cm (19.8 x 8.1 x 25.1 in.) w/o cabinet: 48.3 x 18.8 x 63.8 cm (19 x 7 x 25.1 in.)
Export Classification:	3A001

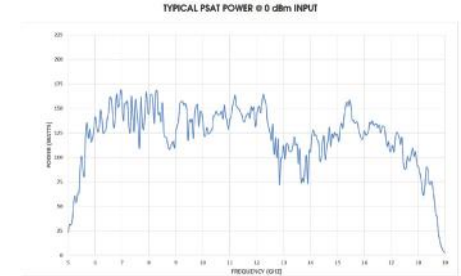

Solid State Pulse Amplifiers

For automotive and military EMC radiated immunity susceptibility testing, as well as radar and communication applications, Solid State Pulsed Amplifiers offer high-power RF levels that rival those of TWTs. However, they offer higher reliability, better mismatch tolerance, much better harmonic distortion, and better MTBF (Mean Time Between Failure) than TWTs.



1300SP1G2



Solid State Pulse

Frequency Range
1 - 4 GHz

Power Range
1 - 80 kW

1000SP0z8G2z5

0.8 - 2.5 GHz
1000 W Pulse



Rated Power Output	1000 W min.
Input for Rated Output	.0 milliwatt maximum
Flatness	±2.5 dB maximum
Frequency Response	0.8 – 2.5 GHz instantaneously
Gain (at max. setting)	60 dB min.
Gain Adjustment	Continuous Range 20 dB min., (4096 steps remote)
Input Impedance	50 ohms, VSWR 2.0:1 max
Output Impedance	50 ohms, nominal
Mismatch Tolerance	Will operate without damage or oscillation when connected to any load impedance Alarm and protection above 250 W reflected power. Load VSWR > 3:1 at 1 kW; > 6:1 at 500 W.
Pulse Capability	
Pulse Width	0.1 – 100 microseconds
Pulse Rate (PRF)	50 kHz max.
Duty Cycle	5% max.
RF Rise and Fall	30 ns max. (10% – 90%)
Delay	1 μs max. from pulse input to RF 90%
Pulse Width Distortion	±100 ns max. (difference between TTL Input Gate and RF pulse)
Pulse Off Isolation	60 dB min.
Pulse Input	TTL level, 50 ohm nominal termination
Noise Figure	≤ 12 dB typ.
Harmonic Distortion	≤ -15 dBc max. up to 1.4 GHz @ RF power ≥ 1600 W ≤ -20 dBc max. 2.5 GHz

Spurious	-60 dBc typ.
Primary Power	100 – 264 VAC 50 – 60 Hz, single phase 700 W max.
Connectors	RF input Type N female on front panel RF output Type 7-16 DIN female on front panel forward and reflected sample ports RF output Type N female on rear panel
Pulse input	Type BNC female on rear panel
Remote Interfaces	IEEE-488 24-pin on rear panel Ethernet RJ-45 on rear panel
Safety Interlock	15-pin Subminiature D
Cooling	Forced air (self-contained fans)
Weight	43 kg (95 lb.)
Size (WxHxD)	50.3 x 19.8 x 71.4 cm, 19.8 x 7.8 x 28.1 in
Export Classification	3A999.d

2000SP0z8G2z5

0.8 - 2.5 GHz
2000 W Pulse



Rated Power Output	2000 W min.
Input for Rated Output	0 dBm max.
Flatness	± 1.5 dB typ.; ± 2.5 dB max.
Frequency Response	0.8 – 2.5 GHz instantaneously
Gain (at max. setting)	63 dB min.
Gain Adjustment	20 dB min (4096 step)
Input Impedance	50 ohms, VSWR 2:1 max.
Output Impedance	50 ohms, nominal
Mismatch Tolerance	Will operate without damage or oscillation with any magnitude and phase of source and load impedance.
Pulse Capability	
Pulse Width	0.1 – 100 microseconds
Pulse Rate (PRF)	50 kHz max.
Duty Cycle	5% max.
RF Rise and Fall	30 ns max. (10% – 90%)
Delay	1 μs max. from pulse input to RF 90%
Pulse Width Distortion	±25 ns max. (difference between TTL Input Gate and RF pulse)
Pulse Off Isolation	60 dB min.
Pulse Input	TTL level, 50 ohm nominal termination
Noise Figure	≤ 12 dB typ.
Harmonic Distortion	≤ -15 dBc max. up to 1.4 GHz @ RF power ≥ 1600 W ≤ -20 dBc max. 2.5 GHz
Spurious	-60 dBc typ.

Primary Power	100 – 264 VAC 50 – 60 Hz, single phase 1000 W max.
Connectors	RF input Type N female on front panel RF output Type 7-16 DIN female on front panel forward and reflected sample ports RF output Type N female on rear panel
Pulse input	Type BNC female on rear panel
Remote Interfaces	IEEE-488 24-pin on rear panel Ethernet RJ-45 on rear panel
Safety Interlock	15-pin Subminiature D
Cooling	Forced air (self-contained fans)
Weight	35 kg (77 lb.)
Size (WxHxD)	48.3 x 17.8 x 68.2 cm / 19 x 7 x 26.85 in
Export Classification	3A999.d



Solid State Pulse

Frequency Range
1 - 4 GHz

Power Range
1 - 80 kW

4000SP0z8G2z5

0.8 - 2.5 GHz
4000 W Pulse



Rated Power Output	4000 W min.
Input for Rated Output	0 dBm max.
Flatness	± 1.5 dB typ.; ± 2.5 dB max.
Frequency Response	0.8 - 2.5 GHz instantaneously
Gain (at max. setting)	66 dB min.
Gain Adjustment	20 dB min (4096 step)
Input Impedance	50 ohms, VSWR ≤ 2:1 max.
Output Impedance	50 ohms, nominal
Mismatch Tolerance	Will operate without damage or oscillation with any magnitude and phase of source and load impedance.
Pulse Capability	
Pulse Width	0.1 - 100 microseconds
Pulse Rate (PRF)	50 kHz max.
Duty Cycle	5% max.
RF Rise and Fall	30 ns max. (10% - 90%)
Delay	1 μs max. from pulse input to RF 90%
Pulse Width Distortion	±25 ns max. (difference between TTL Input Gate and RF pulse)
Pulse Off Isolation	60 dB min.
Pulse Input	TTL level, 50 ohm nominal termination
Noise Figure	≤ 12 dB typ.
Harmonic Distortion	≤ -15 dBc max. up to 1.4 GHz @ RF power ≥ 1600 W ≤ -20 dBc max. 2.5 GHz
Spurious	-60 dBc typ.

Primary Power	100 - 264 VAC 50 - 60 Hz, single phase 1800 W max.
Connectors	RF input Type N female on front panel RF output Type 7-16 DIN female on front panel RF output forward and reflected sample ports Type N female on rear panel
Pulse input	Type BNC female on rear panel
Remote Interfaces	IEEE-488 24-pin Ethernet RJ-45 on rear panel
Safety Interlock	15-pin Subminiature D
Cooling	Forced air (self-contained fans)
Weight	86 kg (190 lb.)
Size (WxHxD)	48.3 x 48.8 x 77.5 cm / 19 x 19.2 x 30.5 in
Export Classification	3A999.d

8000SP0z8G2z5

0.8 - 2.5 GHz
8000 W Pulse



Rated Power Output	8000 W min.
Input for Rated Output	0 dBm max.
Flatness	± 1.5 dB typ.; ± 2.5 dB max.
Frequency Response	0.8 - 2.5 GHz instantaneously
Gain (at max. setting)	69 dB min.
Gain Adjustment	20 dB min (4096 step)
Input Impedance	50 ohms, VSWR ≤ 2:1 max.
Output Impedance	50 ohms, nominal
Mismatch Tolerance	Will operate without damage or oscillation with any magnitude and phase of source and load impedance.
Pulse Capability	
Pulse Width	0.1 - 100 microseconds
Pulse Rate (PRF)	50 kHz max.
Duty Cycle	5% max.
RF Rise and Fall	30 ns max. (10% - 90%)
Delay	1 μs max. from pulse input to RF 90%
Pulse Width Distortion	±25 ns max. (difference between TTL Input Gate and RF pulse)
Pulse Off Isolation	60 dB min.
Pulse Input	TTL level, 50 ohm nominal termination
Noise Figure	≤ 12 dB typ.
Harmonic Distortion	≤ -15 dBc max. up to 1.4 GHz @ RF power ≥ 1600 W ≤ -20 dBc max. 2.5 GHz
Spurious	-60 dBc typ.

Primary Power	100 - 264 VAC 50 - 60 Hz, single phase 2500 W max.
Connectors	RF input Type N female on front panel RF output Type 7-16 DIN female on front panel RF output forward and reflected sample ports Type N female on rear panel
Pulse input	Type BNC female on rear panel
Remote Interfaces	IEEE-488 24-pin Ethernet RJ-45 on rear panel
Safety Interlock	15-pin Subminiature D
Cooling	Forced air (self-contained fans)
Weight	125 kg (276 lb.)
Size (WxHxD)	48.3 x 48.8 x 77.5 cm / 19 x 19.2 x 30.5 in
Export Classification	3A999.d



Solid State Pulse

Frequency Range
1 - 4 GHz

Power Range
1 - 80 kW

1300SP1G2 1 - 2 GHz 1300 W Pulse



Rated Power Output	1,300 W min.
Input for Rated Output	1 milliwatt max.
Flatness	±1.5 dB typ. / ±2.5 dB max.
Frequency Response	1 - 2 GHz instantaneously
Gain (at max. setting)	61.2 dB min.
Gain Adjustment	Continuous Range 20 dB min., (4096 steps remote)
Input Impedance	50 ohms, VSWR 2:1 max.
Output Impedance	50 ohms, nominal
Mismatch Tolerance	Output pulse width foldback protection at peak reflected power exceeding 650 W. Will operate without damage or oscillation with any magnitude and phase of source and load impedance.
Pulse Capability	
Pulse Width	0.1 - 50 microseconds
Pulse Rate (PRF)	50 kHz max.
Duty Cycle	6% max.
RF Rise and Fall	30 ns max. (10% - 90%)
Delay	1 µs max. from pulse input to RF 90%
Pulse Width Distortion	±25 ns max. (difference between TTL Input Gate and RF pulse)
Pulse Off Isolation	60 dB min.
Pulse Input	TTL level, 50 ohm nominal termination
Noise Figure	12 dB typ.
Harmonic Distortion	15 dBc max. up to 1.2 GHz@800W; -20 dBc max. 1.2 GHz-2 GHz

Spurious	Minus 60 dBc typ.
Primary Power	100 - 264 VAC 50/60 Hz, single phase 500 W max.
Connectors	RF input Type N female on front panel RF output Type 7-16 DIN female on front panel RF output forward and reflected sample ports Type N female on rear panel
Pulse input	Type BNC female on rear panel
Remote Interfaces	IEEE-488 24-pin Ethernet RJ-45
Safety Interlock	15-pin Subminiature D
Cooling	Forced air (self-contained fans)
Weight	40 kg (88 lb.)
Size (WxHxD)	50.3 x 27.6 x 75 cm / 19.8 x 10.8 x 27 in.
Export Classification	3A999.d

2000SP1G2 1 - 2 GHz 2000 W Pulse

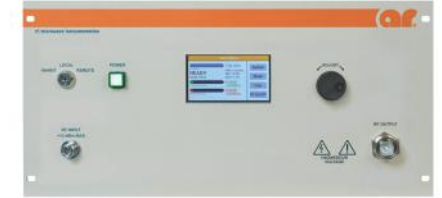

Rated Power Output	2000 W min.
Input for Rated Output	1 milliwatt max.
Flatness	±1.5 dB typ. / ±2.5 dB max.
Frequency Response	1 - 2 GHz instantaneously
Gain (at max. setting)	63 dB min.
Gain Adjustment	Continuous Range 20 dB min., (4096 steps remote)
Input Impedance	50 ohms, VSWR 2:1 max.
Output Impedance	50 ohms, nominal
Mismatch Tolerance	Output pulse width foldback protection at peak reflected power exceeding 1000 W. Will operate without damage or oscillation with any magnitude and phase of source and load impedance.
Pulse Capability	
Pulse Width	.1 - 50 microseconds
Pulse Rate (PRF)	50 kHz max.
Duty Cycle	6% max.
RF Rise and Fall	30 ns max. (10% - 90%)
Delay	1 µs max. from pulse input to RF 90%
Pulse Width Distortion	±25 ns max. (difference between TTL Input Gate and RF pulse)
Pulse Off Isolation	60 dB min.
Pulse Input	TTL level, 50 ohm nominal termination
Noise Figure	12 dB typ.
Harmonic Distortion	-15 dBc max. up to 1.2 GHz; -20 dBc max. 1.2 GHz - 2 GHz
Spurious	Minus 60 dBc typ.

Primary Power	100 - 264 VAC 50/60 Hz, single phase 800 W max.
Connectors	RF input Type N female on front panel RF output Type 7-16 DIN female on front panel RF output forward and reflected sample ports Type N female on rear panel Pulse input Type BNC female on rear panel
Remote Interfaces	IEEE-488 24-pin Ethernet RJ-45
Safety Interlock	15-pin Subminiature D
Cooling	Forced air (self-contained fans)
Weight	42 kg (93 lb.)
Size (WxHxD)	50.3 x 20.3 x 76.2 cm / 19.8 x 8 x 30 in.
Export Classification	3A999.d



Solid State Pulse

Frequency Range
1 - 4 GHz

Power Range
1 - 80 kW

4000SP1G2 1 - 2 GHz 4000 W Pulse



Rated Power Output	4000 W min.
Input for Rated Output	1 milliwatt max.
Flatness	±1.5 dB typ. / ±2.5 dB max.
Frequency Response	1 - 2 GHz instantaneously
Gain (at max. setting)	66 dB min.
Gain Adjustment	Continuous Range 20 dB min., (4096 steps remote)
Input Impedance	50 ohms, VSWR 2:1 max.
Output Impedance	50 ohms, nominal
Mismatch Tolerance	Output pulse width foldback protection at peak reflected power exceeding 2000 W. Will operate without damage or oscillation with any magnitude and phase of source and load impedance.
Pulse Capability	0.1 - 50 microseconds
Pulse Width	0.1 - 50 microseconds
Pulse Rate (PRF)	50 kHz max.
Duty Cycle	6% max.
RF Rise and Fall	30 ns max. (10% to 90%)
Delay	1 μs max. from pulse input to RF 90%
Pulse Width Distortion	±20 ns max. (difference between TTL Input Gate and RF pulse)
Pulse Off Isolation	60 dB min.
Pulse Input	TTL level, 50 ohm nominal termination
Noise Figure	12 dB typ.
Harmonic Distortion	-15 dBc up to 1.2 GHz@2,500W; -20 dBc up to 2 GHz
Spurious	Minus 60 dBc typ.

Primary Power	100 - 264 VAC 50/60 Hz, single phase 1,500 W max.
Connectors	RF input Type N female on front panel RF output Type 7-16 DIN female on front panel RF output forward and reflected sample ports Type N female on rear panel Pulse input Type BNC female on rear panel
Remote Interfaces	IEEE-488 24-pin Ethernet RJ-45
Safety Interlock	15-pin Subminiature D
Cooling	Forced air (self-contained fans)
Weight	170 kg (375 lb.)
Size (WxHxD)	50.3 x 55 x 72 cm / 19.8 x 21.7 x 28.3 in.
Export Classification	3A999.d

8000SP1z2G1z4 1 - 2 GHz 8000 W Pulse



Rated Power Output	8000 W min.
Input for Rated Output	1 milliwatt max.
Flatness	±1.5 dB typ. / ±2 dB max.
Frequency Response	1 - 2 GHz instantaneously
Gain (at max. setting)	69 dB min.
Gain Adjustment	Continuous Range 20 dB min., (4096 steps remote)
Input Impedance	50 ohms
Output Impedance	50 ohms, nominal
Mismatch Tolerance	6:1 maximum. Protection above 3,800W minimum reflected power. No foldback or automatic leveling control on reflected power. If protection is activated, RF output is forced "off".
Pulse Capability	0.1 - 50 microseconds
Pulse Width	0.1 - 50 microseconds
Pulse Rate (PRF)	50 kHz max.
Duty Cycle	6% max.
RF Rise and Fall	30 ns max. (10% - 90%)
Delay	1 μs max. from pulse input to RF 90%
Pulse Width Distortion	±25 ns max. (difference between TTL Input Gate and RF pulse)
Pulse Off Isolation	60 dB min.
Pulse Input	TTL level, 50 ohm nominal termination
Noise Figure	12 dB typ.
Harmonic Distortion	Minus 20 dBc max. at 5000 W Minus 15 dBc max at 5000 W < 1.2 GHz Minus 20 dBc max at 5000 W ≥ 1.2 GHz
Spurious	Minus 60 dBc typ.

Primary Power	100 - 264 VAC 50/60 Hz, single phase 2,500 W max.
Connectors	RF input Type N female on front panel RF output 7/16 DIN female on front panel RF output forward and reflected sample ports Type N female on rear panel Pulse input Type BNC female on rear panel
Remote Interfaces	IEEE-488 24-pin Ethernet RJ-45
Safety Interlock	15-pin Subminiature D
Cooling	Forced air (self-contained fans)
Weight	120 kg (265 lb.)
Size (WxHxD)	50.3 x 52 x 96.5 cm / 19.8 x 20.5 x 38 in.
Export Classification	3A999.d



Solid State Pulse

Frequency Range
1 - 4 GHz

Power Range
1 - 80 kW

1500SP1z2G1z4 1.2 – 1.4 GHz 1500 W Pulse



Rated Power Output	1,500 W min.
Input for Rated Output	1 milliwatt max.
Flatness	±1 dB typ./±2 dB max.
Frequency Response	1.2 – 1.4 GHz instantaneously
Gain (at max. setting)	61.8 dB min.
Gain Adjustment	Continuous Range 20 dB min., (4096 steps remote)
Input Impedance	50 ohms, VSWR 2:1 max.
Output Impedance	50 ohms, nominal
Mismatch Tolerance	Output pulse width foldback protection at peak reflected power exceeding 500 W. Will operate without damage or oscillation when connected to any load impedance.
Pulse Capability	<ul style="list-style-type: none"> Pulse Width 0.1 – 50 microseconds Pulse Rate (PRF) 50 kHz max. Duty Cycle 6% max. RF Rise and Fall 30 ns max. (10% – 90%) Delay ≤1 μs max. from pulse input to RF 90% Pulse Width Distortion ±25 ns max. (difference between TTL Input Gate and RF pulse) Pulse Off Isolation 60 dB min. Pulse Input TTL level, 50 ohm nominal termination
Noise Figure	8 dB max.
Harmonic Distortion	Minus 30 dBc max.
Spurious	Minus 60 dBc typ.

Primary Power	100 – 264 VAC 50/60 Hz, single phase 500 W max.
Connectors	<ul style="list-style-type: none"> RF input Type N female on front panel RF output Type 7–16 DIN female on front panel RF output forward and reflected sample ports Type N female on rear panel Pulse input Type BNC female on rear panel
Remote Interfaces	<ul style="list-style-type: none"> IEEE-488 24-pin Ethernet RJ-45
Safety Interlock	15-pin Subminiature D
Cooling	Forced air (self-contained fans)
Weight	26 kg (58 lb.)
Size (WxHxD)	50.3 x 15 x 78 cm / 19.8 x 5.9 x 30.7 in.
Export Classification	3A999.d

4000SP1z2G1z4 1.2 – 1.4 GHz 4000 W Pulse



Rated Power Output	4000 W min.
Input for Rated Output	1 milliwatt max.
Flatness	±1 dB typ./±2 dB max.
Frequency Response	1.2 – 1.4 GHz instantaneously
Gain (at max. setting)	66 dB min.
Gain Adjustment	Continuous Range 20 dB min., (4096 steps remote)
Input Impedance	50 ohms, VSWR 2:1 max.
Output Impedance	50 ohms, nominal
Mismatch Tolerance	Output pulse width foldback protection at peak reflected power exceeding 2000 W. Will operate without damage or oscillation with any magnitude and phase of source and load impedance.
Pulse Capability	<ul style="list-style-type: none"> Pulse Width 0.1 – 50 microseconds Pulse Rate (PRF) 50 kHz max. Duty Cycle 6% max. RF Rise and Fall 30 ns max. (10% – 90%) Delay 1 μs max. from pulse input to RF 90% Pulse Width Distortion ±25 ns max. (difference between TTL Input Gate and RF pulse) Pulse Off Isolation 60 dB min. Pulse Input TTL level, 50 ohm nominal termination
Noise Figure	15 dB typ.
Harmonic Distortion	Minus 30 dBc max.
Spurious	Minus 60 dBc typ.

Primary Power	100 – 264 VAC 50/60 Hz, single phase 600 W max.
Connectors	<ul style="list-style-type: none"> RF input Type N female on front panel RF output Type 7–16 DIN female on front panel RF output forward and reflected sample ports Type N female on rear panel Pulse input Type BNC female on rear panel
Remote Interfaces	<ul style="list-style-type: none"> IEEE-488 24-pin Ethernet RJ-45
Safety Interlock	15-pin Subminiature D
Cooling	Forced air (self-contained fans)
Weight	35 kg (76 lb.)
Size (WxHxD)	50.3 x 20.8 x 68.2 cm / 19.8 x 8.2 x 24.7 in.
Export Classification	3A999.d



Solid State Pulse

Frequency Range
1 - 4 GHz

Power Range
1 - 80 kW

6000SP1z2G1z4 1.2 - 1.4 GHz 8000 W Pulse



Rated Power Output	6000 W min.
Input for Rated Output	1 milliwatt max.
Flatness	±1 dB typ. / ±2 dB max.
Frequency Response	1.2 - 1.4 GHz instantaneously
Gain (at max. setting)	69 dB min.
Gain Adjustment	Continuous Range 20 dB min., (4096 steps remote)
Input Impedance	50 ohms, VSWR 2:1 max.
Output Impedance	50 ohms, nominal
Mismatch Tolerance	Output pulse width foldback protection at peak reflected power exceeding 4000 W. Will operate without damage or oscillation with any magnitude and phase of source and load impedance.
Pulse Capability	
Pulse Width	0.1 - 50 microseconds
Pulse Rate (PRF)	50 kHz max.
Duty Cycle	6% max.
RF Rise and Fall	30 ns max. (10% - 90%)
Delay	≤1 μs max. from pulse input to RF 90%
Pulse Width Distortion	±25 ns max. (difference between TTL Input Gate and RF pulse)
Pulse Off Isolation	60 dB min.
Pulse Input	TTL level, 50 ohm nominal termination
Noise Figure	8 dB typ.
Harmonic Distortion	Minus 30 dBc max.
Spurious	Minus 60 dBc typ.

Primary Power	100 - 264 VAC 50/60 Hz, single phase 4000 W max.
Connectors	RF input Type N female on front panel RF output Type 7-16 DIN female on front panel RF output forward and reflected sample ports Type N female on rear panel Pulse input Type BNC female on rear panel
Remote Interfaces	IEEE-488 24-pin Ethernet RJ-45
Safety Interlock	15-pin Subminiature D
Cooling	Forced air (self-contained fans)
Weight	90 kg (198.5 lb.)
Size (WxHxD)	50.3 x 51.6 x 79 cm / 19.8 x 20.3 x 31 in.
Export Classification	3A999

9000SP1z2G1z4 1.2 - 1.4 GHz 9000 W Pulse



Rated Power Output	8000 W min.
Input for Rated Output	1 milliwatt max.
Flatness	±1 dB typ. / ±2 dB max.
Frequency Response	1.2 - 1.4 GHz instantaneously
Gain (at max. setting)	69 dB min.
Gain Adjustment	Continuous Range 20 dB min., (4096 steps remote)
Input Impedance	50 ohms, VSWR 2:1 max.
Output Impedance	50 ohms, nominal
Mismatch Tolerance	Output pulse width foldback protection at peak reflected power exceeding 4000 W. Will operate without damage or oscillation with any magnitude and phase of source and load impedance.
Pulse Capability	
Pulse Width	0.1 - 50 microseconds
Pulse Rate (PRF)	50 kHz max.
Duty Cycle	6% max.
RF Rise and Fall	30 ns max. (10% to 90%)
Delay	≤1 μs max. from pulse input to RF 90%
Pulse Width Distortion	±25 ns max. (difference between TTL Input Gate and RF pulse)
Pulse Off Isolation	60 dB min.
Pulse Input	TTL level, 50 ohm nominal termination
Noise Figure	8 dB typ.
Harmonic Distortion	Minus 30 dBc max.
Spurious	Minus 60 dBc typ.

Primary Power	100 - 264 VAC 50/60 Hz, single phase 4000 W max.
Connectors	RF input Type N female on front panel RF output Type 7-16 DIN female on front panel RF output forward and reflected sample ports Type N female on rear panel Pulse input Type BNC female on rear panel
Remote Interfaces	IEEE-488 24-pin Ethernet RJ-45
Safety Interlock	15-pin Subminiature D
Cooling	Forced air (self-contained fans)
Weight	90 kg (198.5 lb.)
Size (WxHxD)	50.3 x 51.6 x 79 cm / 19.8 x 20.3 x 31 in.
Export Classification	3A999



Solid State Pulse

Frequency Range
1 - 4 GHz

Power Range
1 - 80 kW

12000SP1z2G1z4 1.2 - 1.4 GHz 12000 W Pulse



Rated Power Output	12000 W min.
Input for Rated Output	1 milliwatt max.
Flatness	±1 dB typ. / ±2 dB max.
Frequency Response	1.2 - 1.4 GHz instantaneously
Gain (at max. setting)	70.8 dB min.
Gain Adjustment	Continuous Range 20 dB min., (4096 steps remote)
Input Impedance	50 ohms, VSWR 2:1 max.
Output Impedance	50 ohms, nominal
Mismatch Tolerance	Output pulse width foldback protection at peak reflected power exceeding 4000 W. Will operate without damage or oscillation with any magnitude and phase of source and load impedance.
Pulse Capability	
Pulse Width	0.1 - 50 microsecondss
Pulse Rate (PRF)	50 kHz max.
Duty Cycle	6% max.
RF Rise and Fall	30 ns max. (10% to 90%)
Delay	≤1 μs max. from pulse input to RF 90%
Pulse Width Distortion	±25 ns max. (difference between TTL Input Gate and RF pulse)
Pulse Off Isolation	60 dB min.
Pulse Input	TTL level, 50 ohm nominal termination
Noise Figure	8 dB typ.
Harmonic Distortion	Minus 30 dBc max.
Spurious	Minus 60 dBc typ.

Primary Power	100 - 264 VAC 50/60 Hz, single phase 2600 W max.
Connectors	
RF input	Type N female on front panel
RF output	Type 7-16 DIN female on front panel
RF output forward and reflected sample ports	
Pulse input	Type N female on rear panel Type BNC female on rear panel
Remote Interfaces	
IEEE-488	24-pin
Ethernet	RJ-45
Safety Interlock	15-pin Subminiature D
Cooling	Forced air (self-contained fans)
Weight	94 kg (207 lb.)
Size (WxHxD)	50.3 x 50.8 x 90 cm / 19.8 x 20 x 35.4 in.
Export Classification	3A999

18000SP1z2G1z4 1.2 - 1.4 GHz 8000 W Pulse



Rated Power Output	8000 W min.
Input for Rated Output	1 milliwatt max.
Flatness	±1 dB typ. / ±2 dB max.
Frequency Response	1.2 - 1.4 GHz instantaneously
Gain (at max. setting)	72.6 dB min.
Gain Adjustment	Continuous Range 20 dB min., (4096 steps remote)
Input Impedance	50 ohms, VSWR 2:1 max.
Output Impedance	50 ohms, nominal
Mismatch Tolerance	Output pulse width foldback protection at peak reflected power exceeding 4000 W. Will operate without damage or oscillation with any magnitude and phase of source and load impedance.
Pulse Capability	
Pulse Width	0.1 - 50 microsecondss
Pulse Rate (PRF)	50 kHz max.
Duty Cycle	6% max.
RF Rise and Fall	30 ns max. (10% to 90%)
Delay	≤1 μs max. from pulse input to RF 90%
Pulse Width Distortion	±25 ns max. (difference between TTL Input Gate and RF pulse)
Pulse Off Isolation	60 dB min.
Pulse Input	TTL level, 50 ohm nominal termination
Noise Figure	8 dB typ.
Harmonic Distortion	Minus 30 dBc max.
Spurious	Minus 60 dBc typ.

Primary Power	100 - 264 VAC 50/60 Hz, single phase 3700 W max.
Connectors	
RF input	Type N female on front panel
RF output	Type 7-16 DIN female on front panel
RF output forward and reflected sample ports	
Pulse input	Type N female on rear panel Type BNC female on rear panel
Remote Interfaces	
IEEE-488	24-pin
Ethernet	RJ-45
Safety Interlock	15-pin Subminiature D
Cooling	Forced air (self-contained fans)
Weight	105 kg (232 lb.)
Size (WxHxD)	50.3 x 50.8 x 90 cm / 19.8 x 20 x 35.4 in.
Export Classification	3A999



Solid State Pulse

Frequency Range
1 - 4 GHz

Power Range
1 - 80 kW

80000SP1z2G1z4 1.2 - 1.4 GHz 80000 W Pulse



Rated Power Output	80000 W min.
Input for Rated Output	0 dBm max.
Pulse Droop:	-0.8dB max @80000W for a 50µs pulse
Flatness	±1.5 dB typical; ±2.5 dB maximum
Frequency Response	1.2 - 1.4 GHz instantaneously
Gain (at max. setting)	79 dB min.
Gain Adjustment	Continuous Range 20 dB min., (4096 steps remote)
Input Impedance	50 ohms, VSWR 2:1 maximum
Output Impedance	50 ohms, nominal
Mismatch Tolerance	Will operate without damage or oscillation with any magnitude and phase of source and load impedance.
Pulse Capability	
Pulse Width	0.1 - 50 microseconds
Pulse Rate (PRF)	50 kHz maximum
Duty Cycle	6% maximum.
RF Rise and Fall	30 ns max (10% - 90%).
Delay	1µs maximum from pulse input to RF 90%
Pulse Width Distortion	±20 ns maximum (difference between TTL Input Gate and RF pulse)
Pulse Off Isolation	60 dB minimum
Pulse Input	TTL level, 50 ohm nominal termination
Noise Figure	8 dB typ.

Harmonic Distortion	-30 dBc
Spurious	≤ -60 dBc typ.
Primary Power	100 - 264 VAC, 50- 60 Hz, single phase, 16 kW maximum
Connectors	See Model Configurations
RF	RF output forward and reflected sample ports
	Type N female, rear
PULSE INPUT	Type BNC female, rear
Remote Interfaces	
IEEE-488	24 pin
RS-232	9 pin subminiature D
Ethernet	RJ-45
Safety Interlock	15-pin Subminiature D
Cooling	Forced air (self-contained fans)
Weight	1660 kg / 3660 lbs
Size (WxHxD)	60 x 186.3 x 90 cm / 23.6 x 73.3 x 35.4 in
Export Classification	3A999.d

1000SP2G4 2 - 4 GHz 1000 W Pulse



Rated Power Output	1000 W min.
Input for Rated Output	1 milliwatt max.
Flatness	±1.5 dB typ. / ±2.5 dB at rated power
Frequency Response	2 - 4 GHz instantaneously
Gain	60 dB min.
Gain Adjustment	Continuous Range 20 dB min., (4096 steps remote)
Input Impedance	50 ohms, VSWR 2:1 max.
Output Impedance	50 ohms, nominal
Mismatch Tolerance	Output pulse width foldback protection at peak reflected power exceeding 500 W. Will operate without damage or oscillation when connected to any load impedance.
Pulse Capability	
Pulse Width	0.1 - 50 microseconds
Pulse Rate (PRF)	50 kHz max.
Duty Cycle	6% max.
RF Rise and Fall	30 ns max (10% - 90%)
Delay	≤1 µs from pulse input to RF 90%
Pulse Width Distortion	±25 ns max. (difference between TTL Input Gate and RF pulse)
Pulse Off Isolation	60 dB min.
Pulse Input	TTL level, 50 ohm nominal termination
Noise Figure	15 dB typ.
Harmonic Distortion	≤-15dBc up to 2.3GHz@700 W; ≤-20dBc up to 4 GHz
Spurious	Minus 60 dBc typ.

Primary Power	100 - 264 VAC 50/60 Hz, single phase 700 W max.
Connectors	
RF input	Type N female on front panel
RF output	Type 7-16 DIN female on front panel
RF output forward and reflected sample ports	Type N female on rear panel
Pulse input	Type BNC female on rear panel
Remote Interfaces	
IEEE-488	24-pin
Ethernet	RJ-45
Safety Interlock	15-pin Subminiature D
Cooling	Forced air (self-contained fans)
Weight	37 kg (82 lb.)
Size (WxHxD)	50.3 x 22.9 x 68 cm / 19.8 x 9 x 26.8 in.
Export Classification	3A999.d



Solid State Pulse

Frequency Range
1 - 4 GHz

Power Range
1 - 80 kW

2000SP2G4 2 - 4 GHz 2000 W Pulse



Rated Power Output	2000 W min.
Input for Rated Output Flatness	1 milliwatt max. ±1.5 dB typ. / ±2.5 dB at rated power
Frequency Response	2 - 4 GHz instantaneously
Gain (at max. setting)	63 dB min.
Gain Adjustment	Continuous Range 20 dB min., (4096 steps remote)
Input Impedance	50 ohms, VSWR 2:1 max.
Output Impedance	50 ohms, nominal
Mismatch Tolerance	Output pulse width foldback protection at peak reflected power exceeding 1000 W. Will operate without damage or oscillation when connected to any load impedance.
Pulse Capability	Pulse Width .1 - 50 microseconds Pulse Rate (PRF) 50 kHz max. Duty Cycle 6% max. RF Rise and Fall 50 us max. (10% - 90%) Delay 1 μs max. from pulse input to RF 90% Pulse Width Distortion ±25 ns max. (difference between TTL Input Gate and RF pulse) Pulse Off Isolation 60 dB min. Pulse Input TTL level, 50 ohm nominal termination
Noise Figure	15 dB typ.
Harmonic Distortion	-15 dBc max up to 1.2 GHz; -20dBc max 1.2 GHz - 2 GHz
Spurious	Minus 60 dBc typ.

Primary Power	100 - 264 VAC 50/60 Hz, single phase 1000 W max.
Connectors	RF input Type N female on front panel RF output Type 7-16 DIN female on front panel RF output forward and reflected sample ports Type N female on rear panel Pulse input Type BNC female on rear panel
Remote Interfaces	IEEE-488 24-pin Ethernet RJ-45
Safety Interlock	15-pin Subminiature D
Cooling	Forced air (self-contained fans)
Weight	45 kg (99 lb.)
Size (WxHxD)	50.3 x 19.8 x 88.4 cm / 19.8 x 7.8 x 34.8 in.
Export Classification	3A999.d

5000SP2G4 2 - 4 GHz 5000 W Pulse



Rated Power Output	5000 W min.
Input for Rated Output Flatness	1 milliwatt max. ±1.5 dB typical; ±2.5 dB maximum
Pulse Droop:	-0.8dB max @5000W for a 50μs pulse
Frequency Response	2 - 4 GHz instantaneously
Gain (at max. setting)	67 dB min.
Gain Adjustment	Continuous Range 20 dB min., (4096 steps remote)
Input Impedance	50 ohms, VSWR 2:1 maximum
Output Impedance	50 ohms, nominal
Mismatch Tolerance	Output pulse width foldback protection at peak reflected power exceeding 2500 watts. Will operate without damage or oscillation when connected to any load impedance.
Pulse Capability	Pulse Width 0.1-50 microseconds Pulse Rate (PRF) 50 kHz maximum Duty Cycle 6% maximum. RF Rise and Fall 30 ns max (10% to 90%). Delay 1μs maximum from pulse input to RF 90% Pulse Width Distortion ±20 ns maximum (difference between TTL Input Gate and RF pulse) Pulse Off Isolation 60 dB minimum Pulse Input TTL level, 50 ohm nominal termination
Noise Figure	15 dB typ.

Harmonic Distortion	-15dBc up to 2.3GHz@3200W; -20dBc up to 4 GHz
Spurious	Minus 60 dBc typ.
Primary Power	100-264 VAC, 50/60 Hz, single phase, 2000 watts maximum
Connectors	RF See Model Configurations RF output forward and reflected sample ports Type N female, rear PULSE INPUT Type BNC female, rear
Remote Interfaces	IEEE-488 24 pin RS-232 9 pin subminiature D Ethernet RJ-45
Safety Interlock	15-pin Subminiature D
Cooling	Forced air (self-contained fans)
Weight	See Model Configurations
Size (WxHxD)	See Model Configurations
Export Classification	3A999.d

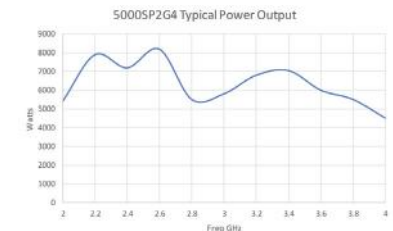

Solid State Pulse

Frequency Range
1 - 4 GHz

Power Range
1 - 80 kW

7000SP2G4 2 - 4 GHz 7000 W Pulse



Rated Power Output	7000 W min.
Input for Rated Output	0 dBm max.
Pulse Droop:	-0.8dB max @5000W for a 50µs pulse
Flatness	±1.5 dB typical; ±2.5 dB maximum
Frequency Response	2 - 4 GHz instantaneously
Gain (at max. setting)	69.5 dB min.
Gain Adjustment	Continuous Range 20 dB min., (4096 steps remote)
Input Impedance	50 ohms, VSWR 2:1 maximum
Output Impedance	50 ohms, nominal
Mismatch Tolerance	Will operate without damage or oscillation with any magnitude and phase of source and load impedance.
Pulse Capability	
Pulse Width	0.1 - 50 microseconds
Pulse Rate (PRF)	50 kHz maximum
Duty Cycle	6% maximum.
RF Rise and Fall	30 ns max (10% - 90%).
Delay	1µs maximum from pulse input to RF 90%
Pulse Width Distortion	±20 ns maximum (difference between TTL Input Gate and RF pulse)
Pulse Off Isolation	60 dB minimum
Pulse Input	TTL level, 50 ohm nominal termination
Noise Figure	15 dB typ.

Harmonic Distortion	-15dBc up to 2.3 GHz@3200 W; -20 dBc up to 4 GHz
Spurious	≤ -60 dBc typ.
Primary Power	100 - 264 VAC, 50 - 60 Hz, single phase, 2800 watts maximum
Connectors	
RF	See Model Configurations output forward and reflected sample ports
RF	Type N female, rear
PULSE INPUT	Type BNC female, rear
Remote Interfaces	
IEEE-488	24 pin
RS-232	9 pin subminiature D
Ethernet	RJ-45
Safety Interlock	15-pin Subminiature D
Cooling	Forced air (self-contained fans)
Weight	102 kg / 225 lbs
Size (WxHxD)	48.3 x 48.8 x 77.5 cm / 19 x 19.2 x 30.5 in
Export Classification	3A999.d

10000SP2G4 2 - 4 GHz 10000 W Pulse



Rated Power Output	10000 W
Input for Rated Output	1 milliwatt max.
Flatness	±2.5 dB typ. / ±1.5 dB max.
Frequency Response	2 - 4 GHz instantaneously
Gain (at max. setting)	70 dB min.
Gain Adjustment	Continuous Range 20 dB min., (4096 steps remote)
Input Impedance	50 ohms, VSWR 2:1 max.
Output Impedance	50 ohms, nominal
Mismatch Tolerance	Output pulse width foldback protection at peak reflected power exceeding 5000 W. Will operate without damage or oscillation with any magnitude and phase of source and load impedance.
Pulse Capability	
Pulse Width	1 µs-50 microseconds
Pulse Rate (PRF)	50 kHz max.
Duty Cycle	6% max.
RF Rise and Fall	50 ns max. (10% - 90%)
Delay	600 ns max. from pulse input to RF 90%
Pulse Width Distortion	±100 ns max. (50% points of output pulse width compared to 50% points of input pulse width)
Pulse Off Isolation	60 dB min.
Pulse Input	TTL level, 50 ohm nominal termination
Noise Figure	15 dB typ.
Harmonic Distortion	≤-15 dBc up to 2.3 GHz @ ≥6,400 W; ≤-20 dBc up to 4 GHz

Spurious	Minus 60 dBc typ.
Primary Power	100 - 264 VAC 50/60 Hz, single phase 3800 W max.
Connectors	
RF input	Type N female on rear panel
RF output	Type 7-16 DIN female on rear panel forward and reflected sample ports
RF output	Type N female on rear panel
Pulse input	Type BNC female on rear panel
Remote Interfaces	
IEEE-488	24-pin
Ethernet	RJ-45
Safety Interlock	15-pin Subminiature D
Cooling	Forced air (self-contained fans)
Weight	125 kg (276 lb.)
Size (WxHxD)	60 x 68 x 90 cm / 23.6 x 26.8 x 35.4 in.
Export Classification	3A999.d



Solid State Pulse

Frequency Range
1 - 4 GHz

Power Range
1 - 80 kW

15000SP2G4

2 - 4 GHz
15000 W Pulse



Rated Power Output	15000 W
Input for Rated Output	0 dBm max.
Flatness	±1.5 dB typ.; ±2.5 dB max.
Frequency Response	2 - 4 GHz instantaneously
Gain (at max. setting)	71.8 dB min.
Gain Adjustment	20 dB (4096 step)
Input Impedance	50 ohms, VSWR 2:1 max.
Output Impedance	50 ohms, nominal
Mismatch Tolerance	Will operate without damage or oscillation with any magnitude and phase of source and load impedance.
Pulse Capability	
Pulse Width	0.1 - 50 µs
Pulse Rate (PRF)	50 kHz max.
Duty Cycle	6% max.
RF Rise and Fall	30 ns max. (10% - 90%)
Delay	≤ 1µs from pulse trig. input to RF 90%
Pulse Width Distortion	±25 ns max. (difference between TTL input gate and RF pulse)
Pulse Off Isolation	60 dB min.
Pulse Input	TTL level, 50 ohm nominal termination
Noise Figure	15 dB typ.
Harmonic Distortion	≤ -15 dBc up to 2,3 GHz @ RF power ≥ 9,500 W ≤ -20 dBc up to 4 GHz
Spurious	≤ -60 dBc

Primary Power	3 phases 100 - 264 VAC 50/60 HZ 7,300 watts max. total 3 phases; 2600W max. on one phase
Connectors	RF input Type N female on rear panel RF output EIA 7/8" female on rear panel RF output forward and reflected sample ports Type N female on rear panel Pulse input BNC on rear panel
Remote Interfaces	EEE-488 24 pins on rear panel Ethernet RJ45 on rear panel Remote interface RS 232 9 pins D Subminiature
Safety Interlock	15-pin Subminiature D
Cooling	Forced air (self-contained fans)
Weight	440 kg / 970 lbs
Size (WxHxD)	60 x 159,6 x 90 cm / 23.6 x 62.8 x 35.4 in
Export Classification	3A999.d

20000SP2G4

2 - 4 GHz
20000 W Pulse



Rated Power Output	20000 W
Input for Rated Output	0 dBm max.
Flatness	±2.5 dB typ. / ±1.5 dB max.
Frequency Response	2 - 4 GHz instantaneously
Gain (at max. setting)	73 dB min.
Gain Adjustment	Continuous Range 20 dB min., (4096 steps remote)
Input Impedance	50 ohms, VSWR 2:1 max.
Output Impedance	50 ohms, nominal
Mismatch Tolerance	Will operate without damage or oscillation with any magnitude and phase of source and load impedance.
Pulse Capability	
Pulse Width	1 µs - 50 microseconds
Pulse Rate (PRF)	50 kHz max.
Duty Cycle	6% max.
RF Rise and Fall	50 ns max. (10% - 90%)
Delay	600 ns max. from pulse input to RF 90%
Pulse Width Distortion	±100 ns max. (50% points of output pulse width compared to 50% points of input pulse width)
Pulse Off Isolation	60 dB min.
Pulse Input	TTL level, 50 ohm nominal termination
Noise Figure	≤ 15 dB typ.
Harmonic Distortion	≤ -15 dBc up to 2.3 GHz @ ≥ 6,400 W; ≤ -20 dBc up to 4 GHz
Spurious	Minus 60 dBc typ.

Primary Power	3 phases 400 VAC 50/60 Hz, single phase 13 kVA max, total on 3 phases; 5 kVA max. on one phase
Connectors	RF input Type N female on rear panel RF output Type 7-16 DIN female on rear panel RF output forward and reflected sample ports Type N female on rear panel Pulse input Type BNC female on rear panel
Remote Interfaces	IEEE-488 24-pin Ethernet RJ-45
Safety Interlock	15-pin Subminiature D
Cooling	Forced air (self-contained fans)
Weight	500 kg / 1102 lbs
Size (WxHxD)	60 x 220 x 100 cm / 23.6 x 86.6 x 39.4 in
Export Classification	3A999.d



Solid State Pulse

Frequency Range
1 - 4 GHz

Power Range
1 - 80 kW

4000SP2z7G3z1 2.7 - 3.1 GHz 4000 W Pulse



Rated Power Output	4000 W min.
Input for Rated Output	0 dBm max.
Flatness	±1 dB typ. / ±2 dB max.
Frequency Response	2.7 - 3.1 GHz instantaneously
Gain (at max. setting)	65 dB min.
Gain Adjustment	Continuous Range 20 dB min., (4096 steps remote)
Input Impedance	50 ohms, VSWR 2:1 max.
Output Impedance	50 ohms, nominal
Mismatch Tolerance	Output pulse width foldback protection at peak reflected power exceeding 1,500 W. Will operate without damage or oscillation when connected to any load impedance.
Pulse Capability	
Pulse Width	0.1 - 50 microseconds
Pulse Rate (PRF)	50 kHz max.
Duty Cycle	6% max.
RF Rise and Fall	30 ns max. (10% - 90%)
Delay	1 μs max. from pulse input to RF 90%
Pulse Width Distortion	±20 ns max. (difference between TTL Input Gate and RF pulse)
Pulse Off Isolation	60 dB min.
Noise Figure	8 dB typ.
Spurious	Minus 60 dBc typ.
Primary Power	100 - 264 VAC 50/60 Hz, single phase 2000 W max.

Connectors	Type N female on front panel RF input Type 7-16 DIN female on front panel RF output forward and reflected sample ports Type N female on rear panel Pulse input Type BNC female on rear panel
Remote Interfaces	IEEE-488 24-pin Ethernet RJ-45
Safety Interlock	15-pin Subminiature D
Cooling	Forced air (self-contained fans)
Weight	52 kg / 115 lbs
Size (WxHxD)	48.3 x 30.1 x 78.2 cm / 19 x 11.9 x 30.8 in
Export Classification	3A999.d

12000SP2z7G3z1 2.7 - 3.1 GHz 12000 W Pulse



Rated Power Output	12000 W min.
Input for Rated Output	1 milliwatt max.
Flatness	±1 dB typ. / ±2 dB max.
Frequency Response	2.7 - 3.1 GHz instantaneously
Gain (at max. setting)	71 dB min.
Gain Adjustment	Continuous Range 20 dB min., (4096 steps remote)
Input Impedance	50 ohms, VSWR 2:1 max.
Output Impedance	50 ohms, nominal
Mismatch Tolerance	Output pulse width foldback protection at peak reflected power exceeding 500 W. Will operate without damage or oscillation when connected to any load impedance.
Pulse Capability	
Pulse Width	0.1 - 50 microseconds
Pulse Rate (PRF)	50 kHz max.
Duty Cycle	6% max.
RF Rise and Fall	30 ns max. (10% - 90%)
Delay	1 μs max. from pulse input to RF 90%
Pulse Width Distortion	±20 ns max. (difference between TTL Input Gate and RF pulse)
Pulse Off Isolation	60 dB min.
Noise Figure	8 dB typ.
Harmonic Distortion	30 dBc max.
Spurious	Minus 60 dBc typ.
Phase Linearity	±4 deg/100 MHz, typ.

Primary Power	100 - 264 VAC 50/60 Hz, single phase 6000 W max.
Connectors	Type N female on front panel RF input Type 7-16 DIN female on front panel RF output forward and reflected sample ports Type N female on rear panel Pulse input Type BNC female on rear panel
Remote Interfaces	IEEE-488 24-pin
Safety Interlock	15-pin Subminiature D
Cooling	Forced air (self-contained fans)
Weight	114 kg (252 lb.)
Size (WxHxD)	50.3 x 53.3 x 81.3 cm / 19.8 x 21 x 32 in.
Export Classification	3A999.d



Solid State Pulse

Frequency Range
1 - 4 GHz

Power Range
1 - 80 kW

1500/1000SP1z2G3z1

1.2 - 1.4 GHz

2.7 - 3.1 GHz

1500 W Pulse

1000 W Pulse



Rated Power Output	1500 W min.
Input for Rated Output	1 milliwatt max.
Flatness	±1 dB typ./ ±2 dB max.
Frequency Response	1.2 - 1.4 GHz 2.7 - 3.1 GHz instantaneously
Gain (at max. setting)	61.8 dB min. 60 dB min.
Gain Adjustment	Continuous Range 20 dB min., (4096 steps remote)
Input Impedance	50 ohms, VSWR 2.0:1 max.
Output Impedance	50 ohms, nominal
Mismatch Tolerance	Output pulse width foldback protection at peak reflected power exceeding 500 W. Will operate without damage or oscillation when connected to any load impedance.
Pulse Capability	
Pulse Width	0.1 - 50 microseconds
Pulse Rate (PRF)	50 kHz max.
Duty Cycle	6% max.
RF Rise and Fall	30 ns max. (10% - 90%)
Delay	1 μs max. from pulse input to RF 90%
Pulse Width Distortion	±20 ns max. (difference between TTL Input Gate and RF pulse)
Pulse Off Isolation	60 dB min.
Noise Figure	8 dB typ.
Harmonic Distortion	30 dBc max.
Spurious	Minus 60 dBc typ.
Phase Linearity	±4 deg/100 MHz, typ.

Primary Power	100 - 264 VAC 50/60 Hz, single phase 6000 W max.
Connectors	
RF input	Type N female on front panel
RF output	Type 7-16 DIN female on front panel
RF output forward and reflected sample ports	
Pulse input	Type N female on rear panel Type BNC female on rear panel
Remote Interfaces	IEEE-488 24-pin
Safety Interlock	15-pin Subminiature D
Cooling	Forced air (self-contained fans)
Weight	40 kg (87 lb.)
Size (WxHxD)	50.3 x 19.8 x 71.4 cm (19.8 x 7.8 x 28.1 in.)
Export Classification	3A999.d



TWT Amplifiers

CW and Pulse Microwave TWT amplifiers offer up to 20000 W and are compliant with the most stringent specifications and standards.

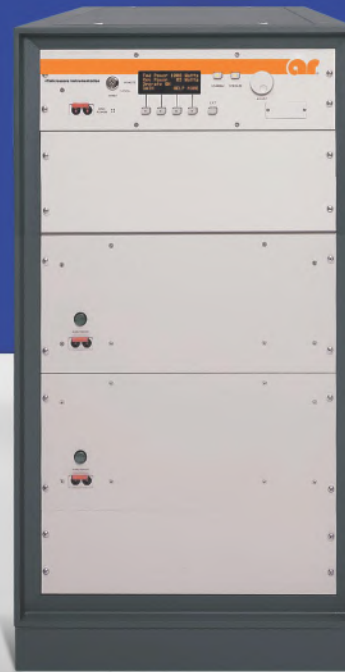

1000TP8G18



TWT Amplifiers

Frequency Range
2.5 – 50 GHz

Power Range
40 W – 20 kW

300T2G8 2.5 – 7.5 GHz 300 W CW



Power (fundamental), CW @ Output Connector
Nominal 350 W / min. 300 W
Linear @ 1 dB Compression 75 W min.

Flatness ±12 dB max, equalized for ±5 dB max. at rated power

Frequency Response 2.5 – 7.5 GHz instantaneously

Input for Rated Output 1 milliwatt max.

Gain (at max. setting) 55 dB min.

Gain Adjustment (continuous range) 35 dB min.

Input Impedance 50 ohms, VSWR 2:1 max.

Output Impedance 50 ohms, VSWR 2.5:1 typ.

Mismatch Tolerance
Output power foldback protection at reflected power exceeding 60 W. Will operate without damage or oscillation with any magnitude and phase of source and load impedance. May oscillate with unshielded open due to coupling to input. Should not be tested with connector off.

Video Pulse Capability
Pulse Width 05 microseconds min.
Pulse Rate (PRF) 100 kHz max.
RF Rise and Fall 30 ns max. (10% – 90%)
Delay 300 ns max. from pulse input to RF 90%
Pulse width distortion ±30 ns max. (50% points of output pulse width compared to 50% points of input pulse width)

Noise Power Density
(pulse on) Minus 75 dBm/Hz max., Minus 80 dBm/Hz typ.
(pulse off) Minus 140 dBm/Hz typ.

Harmonic Distortion Minus 3 dBc max., Minus 4.5 dBc typ.

Primary Power 190 – 260 VAC
50/60 Hz, single phase
3 kVA max.

Connectors
RF input Type N female on rear panel
RF output Type N female on rear panel
RF output sample port Type N female on rear panel
Interlock DB-15 female on rear panel
Video BNC-female on rear panel
GPIO IEEE-488 female on rear panel

Cooling
Forced air (self-contained fans), air entry and exit in rear.

Weight 54 kg (120 lb.)

Size (WxHxD) 50.3 x 29.7 x 68.6 cm / 19.8 x 11.7 x 27 in.

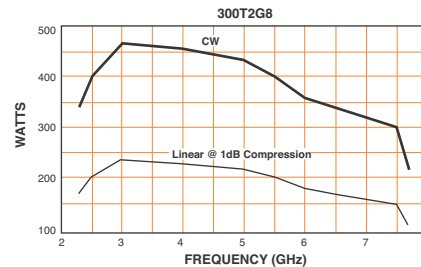

500T2G8 2.5 – 7.5 GHz 500 W CW



Power (fundamental), CW @ Output Connector
Nominal 541 W / min. 500 W
Linear @ 1 dB Compression 125 W min.

Flatness ±8 dB max, equalized for ±5 dB max. at rated power

Frequency Response 2.5 – 7.5 GHz instantaneously

Input for Rated Output 1 milliwatt max.

Gain (at max. setting) 57 dB min.

Gain Adjustment (continuous range) 35 dB min.

Input Impedance 50 ohms, VSWR 2:1 max.

Output Impedance 50 ohms, VSWR 2.5:1 typ.

Mismatch Tolerance
Output power foldback protection at reflected power exceeding 100 W. Will operate without damage or oscillation with any magnitude and phase of source and load impedance. May oscillate with unshielded open due to coupling to input. Should not be tested with connector off.

Video Pulse Capability
Pulse Width 05 microseconds min.
Pulse Rate (PRF) 100 kHz max.
RF Rise and Fall 30 ns max. (10% – 90%)
Delay 300 ns max. from pulse input to RF 90%
Pulse width distortion ±30 ns max. (50% points of output pulse width compared to 50% points of input pulse width)

Noise Power Density
(pulse on) Minus 85 dBm/Hz max., Minus 95 dBm/Hz typ.
(pulse off) Minus 140 dBm/Hz typ.

Harmonic Distortion Minus 3 dBc max., Minus 3.5 dBc typ.

Primary Power 208 VAC ± 10%
50/60 Hz, three phase
3.5 kVA max.

Connectors
RF input Type N female on rear panel
RF output 7-16 DIN female on rear panel
RF output sample port Type N female on rear panel
Interlock DB-15 female on rear panel
Video BNC-female on rear panel
GPIO IEEE-488 female on rear panel

Cooling
Forced air (self-contained fans), air entry and exit in rear.

Weight 55 kg (120 lb.)

Size (WxHxD) 50.8 x 25.4 x 68.6 cm / 20 x 10 x 27 in.

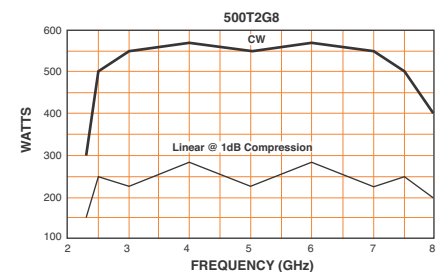

TWT Amplifiers

Frequency Range
2.5 – 50 GHz

Power Range
40 W – 20 kW

1000T2G8B 2.5 – 7.5 GHz 1000 W CW



Power (fundamental), CW, @ Output Connector

Nominal	1,100 W / min. 900 W, 2.5 – 2.7 GHz
	1000 W, 2.7 – 7.5 GHz
Linear @ 1 dB Compression	250 W min.

Flatness ±8 dB max., equalized for ±3 dB max. at rated power

Frequency Response 2.5 – 7.5 GHz instantaneously

Input for Rated Output 1 milliwatt max.

Gain (at max. setting) 60 dB min.

Gain Adjustment (continuous range) 35 dB min.

Input Impedance 50 ohms, VSWR 2:1 max.

Output Impedance 50 ohms, VSWR 2.5:1 typ.

Mismatch Tolerance

Output power foldback protection at reflected power exceeding 200 W. Will operate without damage or oscillation with any magnitude and phase of source and load impedance. May oscillate with unshielded open due to coupling to input. Should not be tested with connector off.

Noise Power Density

Minus 80 dBm/Hz max., Minus 90 dBm/Hz typ.

Harmonic Distortion

Minus 15 dBc max., Minus 17 dBc typ.

Primary Power

190 – 255 VAC
50/60 Hz, three phase, delta (4 wire)
8 kVA max.

Connectors

RF input	Type N female on rear panel
RF output	Type WRD-250 d30 waveguide flange on rear panel
RF output sample port	Type N female on rear panel
Interlock	DB-15 female on rear panel
GPIB	IEEE-488 female on rear panel

Cooling

Forced air (self-contained fans), air entry and exit in rear.

Weight 295 kg (650 lb.)

Size (WxHxD) 56 x 160 x 82.3 cm / 22.1 x 63 x 32.4 in.

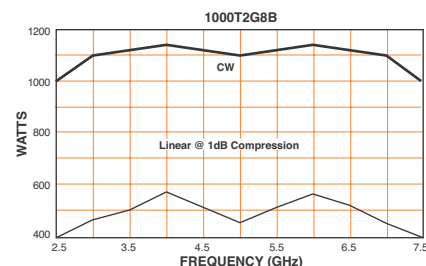

1500T2G8A 2.5 – 7.5 GHz 1700 W CW



Power (fundamental), CW, @ Output Connector

Nominal	2000 W / min. 1,600 W, 2.5 – 3 GHz
	1,700 W, 3 – 7.5 GHz
Linear @ 1 dB Compression	400 W min.

Flatness ±8 dB max., equalized for ±6 dB max. at rated power

Frequency Response 2.5 – 7.5 GHz instantaneously

Input for Rated Output 1 milliwatt max.

Gain (at max. setting) 62 dB min.

Gain Adjustment (continuous range) 35 dB min.

Input Impedance 50 ohms, VSWR 2:1 max.

Output Impedance 50 ohms, VSWR 2.5:1 typ.

Mismatch Tolerance

Output power foldback protection at reflected power exceeding 300 W. Will operate without damage or oscillation with any magnitude and phase of source and load impedance. May oscillate with unshielded open due to coupling to input. Should not be tested with connector off.

Noise Power Density

Minus 85 dBm/Hz max., Minus 95 dBm/Hz typ.

Harmonic Distortion

Minus 15 dBc max., Minus 17 dBc typ.

Primary Power

190 – 255 VAC
50/60 Hz, three phase, delta (4 wire)
11 kVA max.

Connectors

RF input	Type N female on rear panel
RF output	Type WRD-250 d30 waveguide flange on rear panel
RF output sample ports	(forward and reflected) Type N female on rear panel
Interlock	DB-15 female on rear panel
GPIB	IEEE-488 female on rear panel

Cooling

Forced air (self-contained fans), air entry and exit in rear.

Weight 296 kg (650 lb.)

Size (WxHxD) 56 x 160 x 82.3 cm / 22.1 x 63 x 32.4 in.

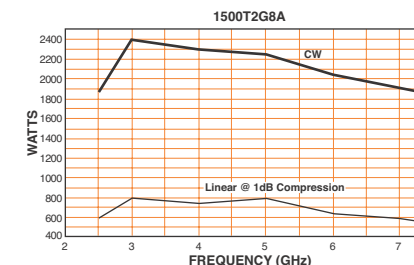

TWT Amplifiers

Frequency Range
2.5 – 50 GHz

Power Range
40 W – 20 kW

200T4G8 4 – 8 GHz 200 W CW



Power (fundamental), CW, @ Output Connector	
Nominal	262 W / min. 200 W
Linear @ 1 dB Compression	100 W min.
Flatness	±6 dB max. at rated power
Frequency Response	4 – 8 GHz instantaneously
Input for Rated Output	1 milliwatt max.
Gain (at max. setting)	53 dB min.
Gain Adjustment (continuous range)	35 dB min.
Input Impedance	50 ohms, VSWR 2:1 max.
Output Impedance	50 ohms, VSWR 2.5:1 typ.

Mismatch Tolerance
Output power foldback protection at reflected power exceeding 40 W. Will operate without damage or oscillation with any magnitude and phase of source and load impedance. May oscillate with unshielded open due to coupling to input. Should not be tested with connector off.

Noise Power Density
Minus 64 dBm/Hz max., Minus 70 dBm/Hz typ.

Harmonic Distortion
Minus 4 dBc max., Minus 7 dBc typ.

Primary Power
190 – 260 VAC
50/60 Hz, single phase
2 kVA max.

Connectors	
RF input	Type N female on rear panel
RF output	Type N female on rear panel
RF output sample port	Type N female on rear panel
Interlock	DB-15 female on rear panel
GPIB	IEEE-488 female on rear panel

Cooling
Forced air (self-contained fans), air entry and exit in rear.

Weight 54 kg (120 lb.)

Size (WxHxD) 50.3 x 29.7 x 68.6 cm / 19.8 x 11.7 x 27 in.

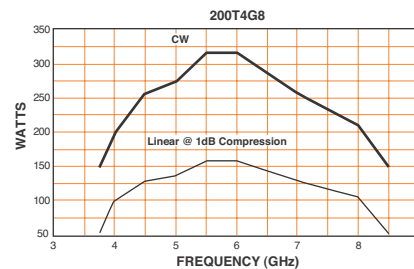

250T6G18 6 – 18 GHz 250 W CW



Power (fundamental), CW @ Output Connector	
Nominal	300 W / min. 250 W
Flatness	±6 dB max. at rated power
Frequency Response	6 – 18 GHz instantaneously
Input for Rated Output	1 milliwatt max.
Gain (at max. setting)	54 dB min.
Gain Adjustment (continuous range)	35 dB min.
Input Impedance	50 ohms, VSWR 2.5:1 max.
Output Impedance	50 ohms, VSWR 2.5:1 typ.

Mismatch Tolerance
Output power foldback protection at reflected power exceeding 50 W. Will operate without damage or oscillation with any magnitude and phase of source and load impedance. May oscillate with unshielded open due to coupling to input. Should not be tested with connector off.

Video Pulse Capability

Pulse Width	1 microseconds min.
Pulse Rate (PRF)	100 kHz max.
RF Rise and Fall	30 ns max. (10% – 90%)
Delay	300 ns max. from pulse input to RF 90%
Pulse width distortion	±30 ns max. (50% points of output pulse width compared to 50% points of input pulse width)

Noise Power Density
(pulse on) Minus 65 dBm/Hz max., Minus 70 dBm/Hz typ.
(pulse off) Minus 140 dBm/Hz typ.

Harmonic Distortion
Minus 5 dBc max., Minus 8 dBc typ.

Primary Power
190–260 VAC, 50/60 Hz, single phase, 2 kVA max.

Connectors	
RF input	Type N female on rear panel
RF output	Type WRD-650 waveguide flange on rear panel
RF output sample port	Type N female on rear panel
Interlock	DB-15 female on rear panel
Video	BNC-female on rear panel
GPIB	IEEE-488 female on rear panel

Cooling
Forced air (self-contained fans), air entry and exit in rear.

Weight 53 kg (115 lb.)

Size (WxHxD) 50.3 x 29.7 x 68.6 cm / 19.8 x 11.7 x 27 in.

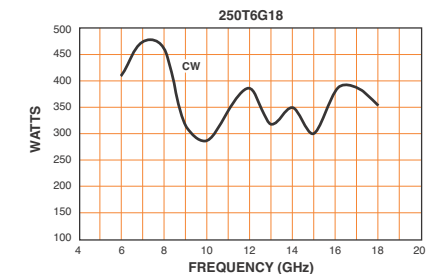

TWT Amplifiers

Frequency Range
2.5 – 50 GHz

Power Range
40 W – 20 kW

500T6G18

6 – 18 GHz
500 W CW



Rated Power Output (6 – 18 GHz)

Minimum	500 W
Typical	600 W

Flatness (maximum @ rated power)	±7 dB max.
----------------------------------	------------

Input for Rated Output	1 milliwatt max.
------------------------	------------------

Gain Adjustment (continuous range)	35 dB min.
------------------------------------	------------

Input Impedance	50 ohms, VSWR 2.5:1 max.
-----------------	--------------------------

Output Impedance	50 ohms, VSWR 2.5:1 typ.
------------------	--------------------------

Harmonic Distortion	Minus 15 dBc max..
---------------------	--------------------

Connectors

RF input	N, female, rear
RF output	WRD-650 waveguide, rear
RF output sample ports	N, female, rear
Interlock	15-pin subminiature D, female

Cooling	Forced air (self-contained fans)
---------	----------------------------------

Weight	91 kg (201 lb.)
--------	-----------------

Size (WxHxD)	50.3 x 37.6 x 76.2 cm / 19.8 x 14.8 x 32 in.
(No Cabinet)	50.3 x 35.6 x 71.1 cm / 19.8 x 14 x 28in.

Export Classification	EAR99
-----------------------	-------



250T8G18

7.5 – 18 GHz
250 W CW



Power (fundamental), CW @ Output Connector

Nominal	300 W / min. 250 W
Linear @ 1 dB Compression	70 W min.

Flatness	±12 dB max., equalized for ±5 dB max. at rated power
----------	--

Frequency Response	7.5 – 18 GHz instantaneously
--------------------	------------------------------

Input for Rated Output	1 milliwatt max.
------------------------	------------------

Gain (at max. setting)	54 dB min.
------------------------	------------

Gain Adjustment (continuous range)	35 dB min.
------------------------------------	------------

Input Impedance	50 ohms, VSWR 2:1 max.
-----------------	------------------------

Output Impedance	50 ohms, VSWR 2.5:1 typ.
------------------	--------------------------

Mismatch Tolerance

Output power foldback protection at reflected power exceeding 50 W. Will operate without damage or oscillation with any magnitude and phase of source and load impedance. May oscillate with unshielded open due to coupling to input. Should not be tested with connector off.

Video Pulse Capability

Pulse Width	05 microseconds min.
Pulse Rate (PRF)	100 kHz max.
RF Rise and Fall	30 ns max. (10% – 90%)
Delay	300 ns max. from pulse input to RF 90%
Pulse width distortion	±30 ns max. (50% points of output pulse width compared to 50% points of input pulse width)

Noise Power Density

(pulse on) Minus 70 dBm/Hz max., Minus 72 dBm/Hz typ.
(pulse off) Minus 140 dBm/Hz typ.

Harmonic Distortion

Below 10 GHz, Minus 5 dBc max., Minus 7 dBc typ.
10–12 GHz, Minus 8 dBc max., Minus 12 dBc typ.
Above 12 GHz, Minus 20 dBc max., Minus 30 dBc typ.

Primary Power

190 – 260 VAC, 50/60 Hz, single phase, 2.5 kVA max.

Connectors

RF input	Type N female on rear panel
RF output	Type WRD-750D24 waveguide flange on rear panel
RF output sample port	Type N female on rear panel
Interlock	DB-15 female on rear panel
Video	BNC-female on rear panel
GPIB	IEEE-488 female on rear panel

Cooling

Forced air (self-contained fans), air entry and exit in rear.

Weight

53 kg (115 lb.)

Size (WxHxD)

50.3 x 29.7 x 68.6 cm / 19.8 x 11.7 x 27 in.

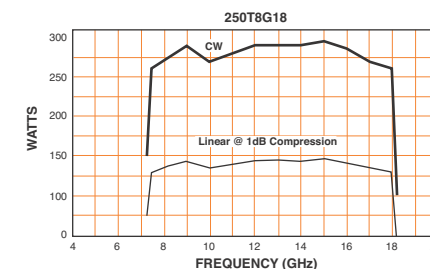

TWT Amplifiers

Frequency Range
2.5 – 50 GHz

Power Range
40 W – 20 kW

500T8G18 7.5 – 18 GHz 500 W CW



Power (fundamental), CW, @ Output Connector
Nominal 543 W / min. 500 W
Linear @ 1 dB Compression 125 W min.

Flatness ±11 dB max., equalized for ±3 dB max. at rated power

Frequency Response 7.5 – 18 GHz instantaneously

Input for Rated Output 1 milliwatt max.

Gain (at max. setting) 57 dB min.

Gain Adjustment (continuous range) 35 dB min.

Input Impedance 50 ohms, VSWR 2:1 max.

Output Impedance 50 ohms, VSWR 2.5:1 typ.

Mismatch Tolerance

Output power foldback protection at reflected power exceeding 100 W. Will operate without damage or oscillation with any magnitude and phase of source and load impedance. May oscillate with unshielded open due to coupling to input. Should not be tested with connector off.

Noise Power Density

Minus 70 dBm/Hz max., Minus 72 dBm/Hz typ.

Harmonic Distortion

Minus 20 dBc/Hz max., Minus 22 dBc/Hz typ.

Primary Power

208 VAC ± 10%, 50/60 Hz, three phase, 4 kVA max.

Connectors

RF input Type N female on rear panel
RF output Type WRD-750D24 waveguide flange on rear panel
RF output sample port Type N female on rear panel
 GPIB IEEE-488 female on rear panel
 Interlock DB-15 female on rear panel

Cooling

Forced air (self-contained fans), air entry and exit in rear.

Weight 91 kg (200 lb.)

Size (WxHxD) 50.3 x 40.6 x 68.6 cm / 19.8 x 16 x 27 in.

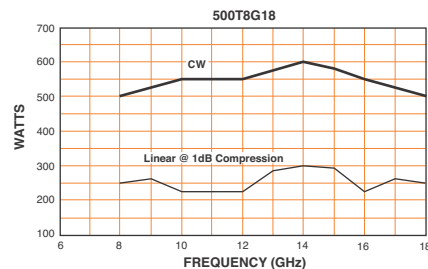

1000T8G18B 7.5 – 18 GHz 1000 W CW



Power (fundamental), CW, @ Output Connector

Nominal 1,100 W
Minimum 1000 W 7.5 – 17 GHz, 925 W 17 – 18 GHz
Linear @ 1 dB Compression 250 W min.

Flatness

±11 dB max., equalized for ±3 dB max. at rated power

Frequency Response 7.5 – 18 GHz instantaneously

Input for Rated Output 1 milliwatt max.

Gain (at max. setting) 60 dB min.

Gain Adjustment (continuous range) 35 dB min.

Input Impedance 50 ohms, VSWR 2:1 max.

Output Impedance 50 ohms, VSWR 2.5:1 typ.

Mismatch Tolerance

Output power foldback protection at reflected power exceeding 200 W. Will operate without damage or oscillation with any magnitude and phase of source and load impedance. May oscillate with unshielded open due to coupling to input. Should not be tested with connector off.

Noise Power Density

Minus 70 dBm/Hz max., Minus 72 dBm/Hz typ.

Harmonic Distortion

Minus 20 dBc max., Minus 27 dBc typ.

Primary Power

190-255 VAC
50/60 Hz, three phase, delta (4 wire)
8 kVA max.

Connectors

RF input Type N female on rear panel
RF output Type WRD-750D24 waveguide flange on rear panel
RF output sample port Type N female on rear panel
 Interlock DB-15 female on rear panel
 GPIB IEEE-488 female on rear panel

Cooling

Forced air (self-contained fans), air entry and exit in rear.

Weight 295 kg (650 lb.)

Size (WxHxD) 56 x 160 x 82.3 cm / 22.1 x 63 x 32.4 in.

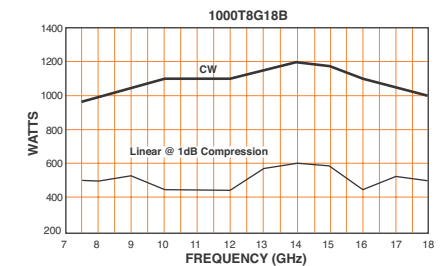

TWT Amplifiers

Frequency Range
2.5 – 50 GHz

Power Range
40 W – 20 kW

1500T8G18

7.5 – 18 GHz
1500 W CW



Power (fundamental), CW, @ Output Connector

Nominal 2000 W / min. 1,500 W
Linear @ 1 dB Compression 375 W min.

Flatness

±11 dB max., equalized for ±6 dB max. at rated power

Frequency Response 7.5 – 18 GHz instantaneously

Input for Rated Output 1 milliwatt max.

Gain (at max. setting) 62 dB min.

Gain Adjustment (continuous range) 35 dB min.

Input Impedance 50 ohms, VSWR 2:1 max.

Output Impedance 50 ohms, VSWR 2.5:1 typ.

Mismatch Tolerance

Output power foldback protection at reflected power exceeding 300 W. Will operate without damage or oscillation with any magnitude and phase of source and load impedance. May oscillate with unshielded open due to coupling to input. Should not be tested with connector off.

Noise Power Density

Minus 70 dBm/Hz max., Minus 72 dBm/Hz typ.

Harmonic Distortion

Minus 20 dBc max., Minus 27 dBc typ.

Primary Power

190 – 255 VAC
50/60 Hz, three phase, delta (4 wire)
16 kVA max.

Connectors

RF input Type N female on rear panel
RF output Type WRD-750D24 waveguide flange on rear panel
RF output sample ports (forward and reverse) Type N female on rear panel

Interlock DB-15 female on rear panel
 GPIB IEEE-488 female on rear panel

Cooling

Forced air (self-contained fans), air entry and exit in rear.

Weight 546 kg (1,200 lb.)

Size (WxHxD) (2 cabinets)
56 x 160 x 84 cm / 22.1 x 63 x 33 in. per cabinet

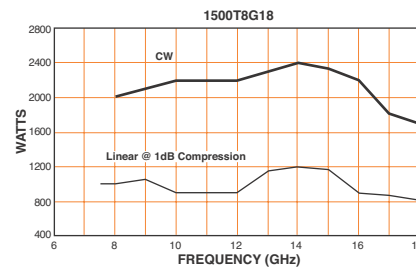

40T18G26A

18 – 26.5 GHz
40 W CW



Power (fundamental), CW, @ Output Connector

Nominal 45 W / min. 40 W
Linear @ 1 dB Compression 10 W min.

Flatness ±8 dB max.

Frequency Response 18 – 26.5 GHz instantaneously

Input for Rated Output 1 milliwatt max.

Gain (at max. setting) 46 dB min.

Gain Adjustment (continuous range) 35 dB min.

Input Impedance 50 ohms, VSWR 2:1 max.

Output Impedance 50 ohms, VSWR 2.5:1 typ.

Mismatch Tolerance

Output power foldback protection at reflected power exceeding 10 W. Will operate without damage or oscillation with any magnitude and phase of source and load impedance. May oscillate with unshielded open due to coupling to input. Should not be tested with connector off.

Video Pulse Capability

Pulse Width 0.1 microseconds min.
Pulse Rate (PRF) 10 kHz max.
Duty Cycle

Some restrictions apply. Contact AR with application requirements.

RF Rise and Fall 30 ns max. (10% – 90%)
Delay 300 ns max from pulse input to RF90%
Pulse Width Distortion

30 ns max (50% points of output pulse width compared to 50% points of input pulse width)

Noise Power Density (pulse off) Minus 140 dBm/Hz typ.
Pulse Off Isolation 80 dB min., 90 dB typ.
Pulse Input

TTL Level, 50 Ohm nominal termination, high level enables RF when video pulsing mode is selected.

Noise Power Density

Minus 60 dBm/Hz max., Minus 65 dBm/Hz typ.

Harmonic Distortion -15 dBc max.

Primary Power 99 – 260 VAC
50/60 Hz, single phase
850 VA max.

Connectors

RF input Type K female on rear panel
RF output Type WR-42 waveguide flange on rear panel
RF output sample port Type K female on rear panel
Interlock DB-15 female on rear panel
 GPIB IEEE-488 female on rear panel

Cooling

Forced air (self-contained fans), air entry and exit in rear.

Weight 30 kg (65 lb.)

Size (WxHxD) 50.3 x 16.5 x 68.6 cm / 19.8 x 6.5 x 27 in.

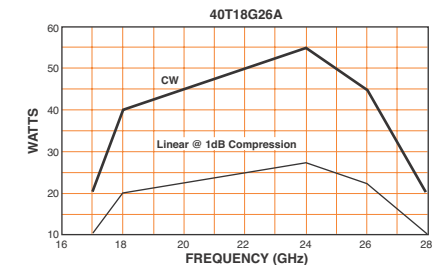

TWT Amplifiers

Frequency Range
2.5 – 50 GHz

Power Range
40 W – 20 kW

130T18G26z5B 18 – 26.5 GHz 130 W CW



Power (fundamental), CW, @ Output Connector	
Nominal	150 W / min. 130 W
Linear @ 1 dB Compression	30 W min.
Flatness	±9 dB max.
Frequency Response	18 – 26.5 GHz instantaneously
Input for Rated Output	1 milliwatt max.
Gain (at max. setting)	52 dB min.
Gain Adjustment (continuous range)	35 dB min.
Input Impedance	50 ohms, VSWR 2:1 max.
Output Impedance	50 ohms, VSWR 2.5:1 typ.

Mismatch Tolerance
Output power foldback protection at reflected power exceeding 20 W. Will operate without damage or oscillation with any magnitude and phase of source and load impedance. May oscillate with unshielded open due to coupling to input. Should not be tested with connector off.

Noise Power Density
Minus 70 dBm/Hz max., Minus 75 dBm/Hz typ.

Harmonic Distortion
Minus 15 dBc max., Minus 20 dBc typ.

Primary Power
190 – 260 VAC
50/60 Hz, single phase
0.8 kVA max.

Connectors	
RF input	Type K female on rear panel
RF output	Type WR-42 waveguide flange on rear panel
RF output sample port	Type K female on rear panel
Interlock	DB-15 female on rear panel
GPIB	IEEE-488 on rear panel
Video	BNC female on rear panel

Cooling
Forced air (self-contained fans), air entry and exit in rear.

Weight 36 kg (80 lb.)

Size (WxHxD) 50.3 x 16.5 x 68.6 cm / 19.8 x 6.5 x 27 in.

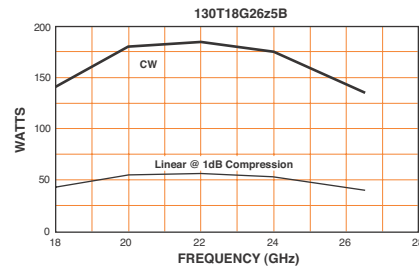

200T18G26z5A 18 – 26.5 GHz 200 W CW



Power (fundamental), CW, @ Output Connector	
Nominal	225 W / min. 200 W
Linear @ 1 dB Compression	50 W min.
Flatness	±10 dB max.
Frequency Response	18–26.5 GHz instantaneously
Input for Rated Output	1 milliwatt max.
Gain (at max. setting)	53 dB min.
Gain Adjustment (continuous range)	35 dB min.
Input Impedance	50 ohms, VSWR 2:1 max.
Output Impedance	50 ohms, VSWR 2.5:1 typ.

Mismatch Tolerance
Output power foldback protection at reflected power exceeding 40 W. Will operate without damage or oscillation with any magnitude and phase of source and load impedance. May oscillate with unshielded open due to coupling to input. Should not be tested with connector off.

Video Pulse Capability
Pulse Width 0.1 microseconds min.
Pulse Rate (PRF) 10 kHz max.
Duty Cycle

Some restrictions apply. Contact AR with application requirements.
RF Rise and Fall 100 ns max. (10% – 90%)
Delay 500 ns max from pulse input to RF90%
Pulse Width Distortion 200 ns max (50% points of output pulse width compared to 50% points of input pulse width)
Noise Power Density (pulse off) Minus 140 dBm/Hz typ.
Pulse Off Isolation 80 dB min., 90 dB typ.
Pulse Input

TTL Level, 50 Ohm nominal termination, high level enables RF when video pulsing mode is selected.

Noise Power Density
Minus 70 dBm/Hz max., Minus 75 dBm/Hz typ.

Harmonic Distortion
Minus 20 dBc max., Minus 30 dBc typ.

Primary Power
190 – 260 VAC
50/60 Hz, single phase
3 kVA max.

Connectors	
RF input	Type K female on rear panel
RF output	Type WR-42 waveguide flange on rear panel
RF output sample port	Type K female on rear panel
Interlock	DB-15 female on rear panel
GPIB	IEEE-488 on rear panel

Cooling
Forced air (self-contained fans), air entry and exit in rear.

Weight 91 kg (200 lb.)

Size (WxHxD) 50.3 x 43 x 81 cm / 19.8 x 17 x 32 in.

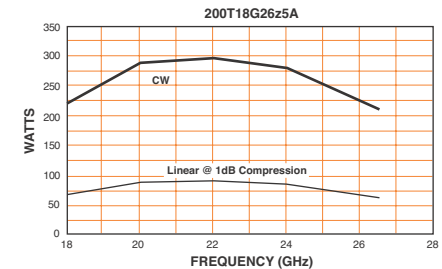

TWT Amplifiers

Frequency Range
2.5 – 50 GHz

Power Range
40 W – 20 kW

40T26G40A 26.5 – 40 GHz 40 W CW



Power (fundamental), CW, @ Output Connector
Nominal 45 W / min. 40 W
Linear @ 1 dB Compression 10 W min.

Flatness ±8 dB max.

Frequency Response 26.5 – 40 GHz instantaneously

Input for Rated Output 1 milliwatt max.

Gain (at max. setting) 46 dB min.

Gain Adjustment (continuous range) 35 dB min.

Input Impedance 50 ohms, VSWR 2:1 max.

Output Impedance 50 ohms, VSWR 2.5:1 typ.

Mismatch Tolerance
Output power foldback protection at reflected power exceeding 10 W. Will operate without damage or oscillation with any magnitude and phase of source and load impedance. May oscillate with unshielded open due to coupling to input. Should not be tested with connector off.

Noise Power Density
Minus 60 dBm/Hz max., Minus 70 dBm/Hz typ.

Harmonic Distortion -15 dbc max.

Primary Power
99 – 260 VAC
50/60 Hz, single phase
850 VA max.

Connectors
RF input Type K female on rear panel
RF output Type WR-28 waveguide flange on rear panel
RF output sample port Type K female on rear panel
Interlock DB-15 female on rear panel
 GPIB IEEE-488 on rear panel

Cooling
Forced air (self-contained fans), air entry and exit in rear.

Weight 30 kg (65 lb.)

Size (WxHxD)
50.3 x 16.5 x 68.6 cm / 19.8 x 6.5 x 27 in.

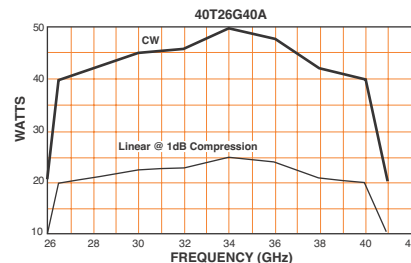

130T26z5G40B 26.5 – 40 GHz 130 W CW



Power (fundamental), CW, @ Output Connector
Nominal 150 W / min. 130 W
Linear @ 1 dB Compression 30 W min.

Flatness ±10 dB max.

Frequency Response 26.5 – 40 GHz instantaneously

Input for Rated Output 1 milliwatt max.

Gain (at max. setting) 52 dB min.

Gain Adjustment (continuous range) 35 dB min.

Input Impedance 50 ohms, VSWR 2:1 max.

Output Impedance 50 ohms, VSWR 2.5:1 typ.

Mismatch Tolerance
Output power foldback protection at reflected power exceeding 20 W. Will operate without damage or oscillation with any magnitude and phase of source and load impedance. May oscillate with unshielded open due to coupling to input. Should not be tested with connector off.

Noise Power Density
Minus 70 dBm/Hz max., Minus 75 dBm/Hz typ.

Harmonic Distortion
Minus 15 dBc max., Minus 20 dBc typ.

Primary Power
190 – 260 VAC
50/60 Hz, single phase
0.8 kVA max.

Connectors
RF input Type K female on rear panel
RF output Type WR-28 waveguide flange on rear panel
RF output sample port Type K female on rear panel
Interlock DB-15 female on rear panel
 GPIB IEEE-488 on rear panel

Cooling
Forced air (self-contained fans), air entry and exit in rear.

Weight 36 kg (80 lb.)

Size (WxHxD)
50.3 x 16.5 x 68.6 cm / 19.8 x 6.5 x 27 in.

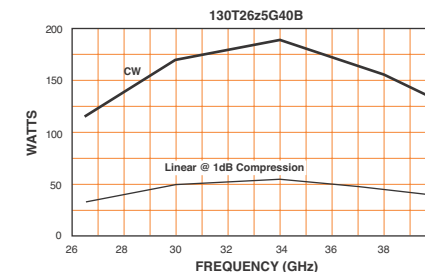

TWT Amplifiers

Frequency Range
2.5 – 50 GHz

Power Range
40 W – 20 kW

200T26z5G40A

26.5 – 40 GHz
200 W CW



Power (fundamental), CW, @ Output Connector	
Nominal	225 W / min. 200 W
Linear @ 1 dB Compression	50 W min.
Flatness ±10 dB max.	
Frequency Response 26.5 – 40 GHz instantaneously	
Input for Rated Output 1 milliwatt max.	
Gain (at max. setting) 53 dB min.	
Gain Adjustment (continuous range) 35 dB min.	
Input Impedance 50 ohms, VSWR 2:1 max.	
Output Impedance 50 ohms, VSWR 2.5:1 typ.	

Mismatch Tolerance
Output power foldback protection at reflected power exceeding 40 W. Will operate without damage or oscillation with any magnitude and phase of source and load impedance. May oscillate with unshielded open due to coupling to input. Should not be tested with connector off.

Video Pulse Capability	
Pulse Width	0.1 microseconds min.
Pulse Rate (PRF)	10 kHz max.
Duty Cycle	Some restrictions apply. Contact AR with application requirements.
RF Rise and Fall	100 ns max. (10% – 90%)
Delay	500 ns max from pulse input to RF90%
Pulse Width Distortion	200 ns max (50% points of output pulse width compared to 50% points of input pulse width)
Noise Power Density (pulse off)	Minus 140 dBm/Hz typ.
Pulse Off Isolation	80 dB min., 90 dB typ.
Pulse Input	TTL Level, 50 Ohm nominal termination, high level enables RF when video pulsing mode is selected.

Noise Power Density	
Minus 70 dBm/Hz max., Minus 75 dBm/Hz typ.	
Harmonic Distortion	
Minus 20 dBc max., Minus 30 dBc typ.	
Primary Power	
190 – 260 VAC	
50/60 Hz, single phase	
3 kVA max.	
Connectors	
RF input	Type K female on rear panel
RF output	Type WR-42 waveguide flange on rear panel
RF output sample port	Type K female on rear panel
Interlock	DB-15 female on rear panel
GPIB	IEEE-488 on rear panel

Cooling
Forced air (self-contained fans), air entry and exit in rear.

Weight 91 kg (200 lb.)

Size (WxHxD) 50.3 x 43 x 81 cm / 19.8 x 17 x 32 in.

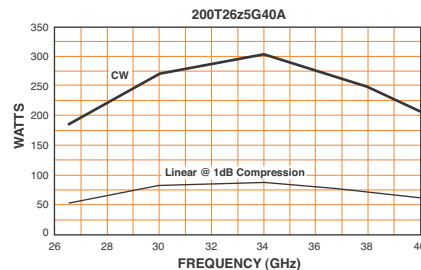

70T40G50

40 – 50 GHz
70 W CW



Power (fundamental), CW, @ Output Flange	
Minimum	70 W, 40 GHz – 45 GHz
	50 W, 45 GHz – 50 GHz
Flatness ±3 dB max. at rated power	
Frequency Response 40 – 50 GHz instantaneously	
Input for Rated Output 1 milliwatt max.	
Gain (at maximum setting) 47 dB min.	
Gain Adjustment (continuous range) 35 dB min.	
Input Impedance 50 ohms, VSWR 2:1 max.	
Output Impedance 50 ohms, VSWR 2.5:1 typ.	

Mismatch Tolerance
Output power foldback protection at reflected power exceeding 20 W. Will operate without damage or oscillation with any magnitude and phase of source and load impedance. May oscillate with unshielded open due to coupling to input. Should not be tested with connector off.

Harmonic Distortion Minus 15 dBc typ.	
Spurious Response (non-harmonic) Minus 15 dBc typ. (excluding harmonics)	

Primary Power
190 – 260 VAC
50/60 Hz, single phase
1.5 kVA max.

Connectors	
RF input	Type 2.4 mm female on rear panel
RF output	Type WR-22 waveguide flange on rear panel, all tapped
RF output sample ports (forward and reflected)	Type 2.4 mm female on rear panel
Remote Interface	IEEE-488
Interlock	DB-15 female on rear panel

Cooling
Forced air (self-contained fans), air entry and exit in rear.

Weight 42 kg (93 lb.)

Size (WxHxD) 48.26 x 16.5 x 76.2 cm / 19 x 6.5 x 30 in.

Export Classification EAR99

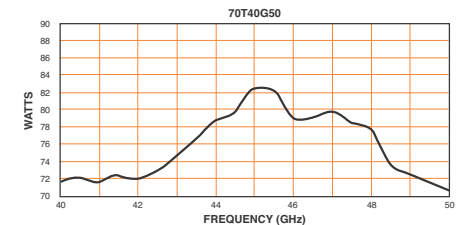

TWT Amplifiers

Frequency Range
2.5 – 50 GHz

Power Range
40 W – 20 kW

100T40G50 40 – 50 GHz 100 W CW



Power (fundamental), CW, @ Output Connector
Minimum 100 W

Flatness ±8 dB max.

Frequency Response 40 – 50 GHz instantaneously

Input for Rated Output 1 milliwatt max.

Gain Adjustment (continuous range) 35 dB min.

Input Impedance 50 ohms, VSWR 2:1 max.

Output Impedance 50 ohms, VSWR 2.5:1 typ.

Mismatch Tolerance

Output power foldback protection at reflected power exceeding 8 W. Will operate without damage or oscillation with any magnitude and phase of source and load impedance. May oscillate with unshielded open due to coupling to input. Should not be tested with connector off.

Modulation Capability:

Will faithfully reproduce AM, FM, or pulse modulation appearing on the input signal. AM peak envelope power limited to specified power.

Harmonic Distortion

Minus 22 dBc typ.

Primary Power

190 – 260 VAC
50/60 Hz, single phase
1.5 kVA max.

Connectors

RF input Type 2.4 mm female on rear panel
RF output Type WR-22 waveguide flange on rear panel
RF output sample ports Type 2.4 mm female on rear panel
Interlock DB-15 female on rear panel
GPIO IEEE-488 female on rear panel

Cooling

Forced air (self-contained fans), air entry and exit in rear.

Weight 82 kg (180 lb.)

Size (WxHxD) 50.3 x 43 x 76 cm / 19.8 x 17 x 30 in.

Export Classification EAR99

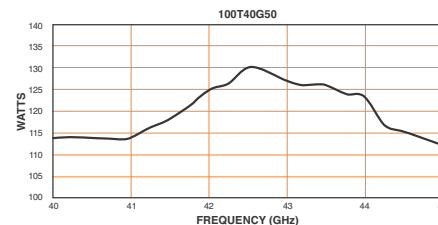

4000TP2G4 2 – 4 GHz 4000 W Pulse



Power (fundamental), Peak Pulse, @ Output
Nominal 5800 W / min. 4.7 kW

Flatness ±10 dB max.

Frequency Response 2 – 4 GHz

Input for Rated Output 1 milliwatt max.

Gain (at max. setting) 66 dB min.

Gain Adjustment (continuous range) 35 dB min.

Input Impedance 50 ohms, VSWR 2.5:1 max.

Output Impedance 50 ohms, VSWR 2.5:1 typ.

Mismatch Tolerance

Output pulse width foldback protection at peak reflected power exceeding 1000 W. Will operate without damage with any magnitude and phase of source and load impedance. May oscillate with unshielded open due to coupling to input. Should not be tested with connector off.

Pulse Capability

Pulse Width 07 – 50 microseconds
Pulse Rate (PRF) 100 kHz max.
Duty Cycle 4% max.
RF Rise and Fall 35 ns max. (10% – 90%)
Delay 300 ns max. from pulse input to RF 90%
Pulse Width Distortion ±50 ns max. (50% points of output pulse width compared to 50% points of input pulse width)
Pulse Off Isolation 80 dB min., 90 dB typ.
Pulse Input TTL level, 50 ohm nominal termination

Noise Power Density

(pulse on) Minus 57 dBm/Hz max., Minus 59 dBm/Hz typ.
(pulse off) Minus 140 dBm/Hz typ.

Harmonic Distortion Minus 0 dBc max.

Primary Power 208 VAC ± 10%
208 VAC ± 10%
Three phase, 50/60 Hz
3 kVA max.

Connectors

RF input Type N female on rear panel
RF output Type N female on rear panel
RF output forward sample port Type N female on rear panel
Pulse input Type BNC female on rear panel
Interlock DB-15 female on rear panel
GPIO IEEE-488 female on rear panel

Cooling

Forced air (self-contained fans), air entry and exit in rear.

Weight 75 kg (165 lb.)

Size (WxHxD) 51 x 30.5 x 84 cm / 19.8 x 12 x 33 in.

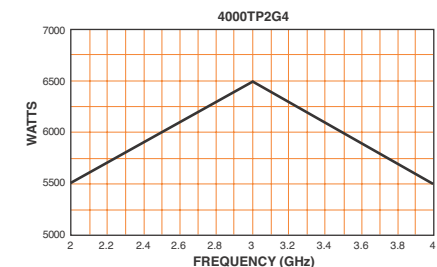

Product Catalog | 2023

For Sales, call: 215.723.8181

For an Applications Engineer, call: 800.933.8181

arworld.us

69

Contents

Find it Fast

RF Solid State

Universal Series

Microwave

Solid State Pulse

TWT

Systems

Antennas

Accessories

Contact

AR Companies

TWT Amplifiers

Frequency Range
2.5 – 50 GHz

Power Range
40 W – 20 kW

6900TP2G4 2 – 4 GHz 6900 W Pulse



Power (fundamental), Peak Pulse, @ Output	
Nominal	9000 W; Minimum, 6900 W
Flatness	±8 dB maximum, ±4 dB at rated power
Frequency Response	2 – 4 GHz
Input for Rated Output	1 milliwatt max.
Gain (at max. setting)	68 dB min.
Gain Adjustment (continuous range)	35 dB min.
Input Impedance	50 ohms, VSWR 2.5:1 max.
Output Impedance	50 ohms, VSWR 2.5:1 typ.

Mismatch Tolerance
Output pulse width foldback protection at peak reflected power exceeding 4000 watts. Will operate without damage or oscillation with any magnitude and phase of source and load impedance. May oscillate with unshielded open due to coupling to input. Should not be tested with connector off.

Pulse Capability	
Pulse Width	0.2 – 50 microseconds.
Pulse Rate (PRF)	100 kHz maximum
Duty Cycle	4% maximum.
RF Rise and Fall	70 ns max (10% – 90%).
Delay	500 ns maximum from pulse input to RF 90%
Pulse Width Distortion	±50 ns maximum (50% points of output pulse width compared to 50% points of input pulse width)
Pulse Off Isolation	80 dB minimum, 90 dB typical
Pulse Input	TTL level, 50 ohm nominal termination

Noise Power Density	
(pulse on)	Minus 55 dBm/Hz (maximum); Minus 84 dBm/Hz (typical)
(pulse off)	Minus 140 dBm/Hz (typical)
Harmonic Distortion	Minus 15 dBc max.
Primary Power	See Model Configurations
Connectors	
RF input:	Type N female on rear panel
RF output:	Type DIN 7-16 female on rear panel
RF output sample ports (forward and reflected):	Type N female on rear panel
Pulse input:	Type BNC female on rear panel
GPIB:	IEEE-488 female on rear panel
Interlock:	DB-15 female on rear panel

Cooling
Forced air (self-contained fans), air entry and exit in rear.

Weight 121 kg, 265 lbs

Size (WxHxD) 50.3 x 48 x 89 cm, 19.8 x 19 x 35 in

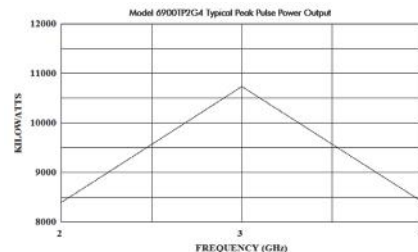

2000TP2G8B 2.5 – 7.5 GHz 2000 W Pulse



Power (fundamental), Peak Pulse, @ Output Connector	
Nominal	2,200 W / min. 2000 W
Flatness	±13 dB max., equalized for ±4 dB max. at rated power
Frequency Response	2.5 – 7.5 GHz instantaneously
Input for Rated Output	1 milliwatt max.
Gain (at max. setting)	63 dB min.
Gain Adjustment (continuous range)	35 dB min.
Input Impedance	50 ohms, VSWR 2.5:1 max.
Output Impedance	50 ohms, VSWR 2.5:1 typ.

Mismatch Tolerance
Output pulse width foldback protection at peak reflected power exceeding 1000 W. Will operate without damage or oscillation with any magnitude and phase of source and load impedance. May oscillate with unshielded open due to coupling to input. Should not be tested with connector off.

Pulse Capability	
Pulse Width	07 – 30 microseconds
Pulse Rate (PRF)	100 kHz max.
Duty Cycle	4% max.
RF Rise and Fall	30 ns max (10% – 90%)
Delay	300 ns max. from pulse input to RF 90%
Pulse Width Distortion	±30 ns max (50% points of output pulse width compared to 50% points of input pulse width)
Pulse Off Isolation	80 dB min., 90 dB typ.
Pulse Input	TTL level, 50 ohm nominal termination

Noise Power Density	
(pulse on)	Minus 70 dBm/Hz max., Minus 72 dBm/Hz typ.
(pulse off)	Minus 140 dBm/Hz typ.

Harmonic Distortion Minus 0 dBc max., Minus 1.5 dBc typ.

Primary Power 190 – 260 VAC
Single phase, 50/60 Hz
1.2 kVA max.

Connectors	
RF input	Type N female on rear panel
RF output	Type N female on rear panel
RF output sample port	Type N female on rear panel
Pulse input	Type BNC female on rear panel
Interlock	DB-15 female on rear panel
GPIB	IEEE-488 female on rear panel

Cooling
Forced air (self-contained fans), air entry and exit in rear.

Weight 53 kg (115 lb.)

Size (WxHxD) 50.3 x 25.4 x 82 cm / 19.8 x 10 x 32 in.

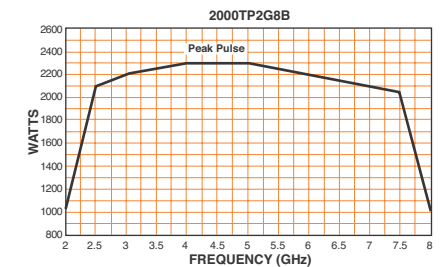

TWT Amplifiers

Frequency Range
2.5 – 50 GHz

Power Range
40 W – 20 kW

8000TP2z7G3z1

2.7 – 3.1 GHz
8000 W Pulse



Power (fundamental), CW, @ Output Connector	
Nominal	10000 W / min. 8000 W
Flatness	±6 dB max.
Frequency Response 2.7 – 3.1 GHz instantaneously	
Input for Rated Output 1 milliwatt max.	
Gain (at max. setting) 69 dB min.	
Gain Adjustment (continuous range) 35 dB min.	
Input Impedance 50 ohms, VSWR 2.5:1 max.	
Output Impedance 50 ohms, VSWR 2.5:1 typ.	
Mismatch Tolerance Will operate without damage or oscillation with any magnitude and phase of source and load impedance. May oscillate with unshielded open due to coupling to input. Should not be tested with connector off.	
Pulse Capability	
Pulse Width	0.1 – 40 microseconds
Pulse Rate (PRF)	100 kHz max.
Duty Cycle	1% max.
RF Rise and Fall	50 ns max. (10% – 90%)
Delay	500 ns max. from pulse input to RF 90%
Pulse Width Distortion	±30 ns max. (50% points of output pulse width compared to 50% points of input pulse width)
Pulse Off Isolation	80 dB min., 90 dB typ.
Pulse Input	TTL level, 50 ohm nominal termination
Noise Power Density	
(pulse on)	Minus 55 dBm/Hz max., Minus 80 dBm/Hz typ.
(pulse off)	Minus 140 dBm/Hz typ.
Harmonic Distortion Minus 20 dBc max.	

Primary Power 190 – 255 VAC 50/60 Hz, three phase, delta (4 wire) 2 kVA max.	
Connectors	
RF input	Type N female on rear panel
RF output	Type DIN 7–16 female on rear panel
RF output sample ports (forward and reflected)	Type N female on rear panel
RF output	Type BNC female on rear panel
Interlock	DB–15 female on rear panel
GPIB	IEEE–488 female on rear panel
Cooling Forced air (self-contained fans), air entry and exit in rear.	
Weight 61 kg (135 lb.)	
Size (WxHxD) 50.3 x 26 x 88.9 cm / 19.8 x 10.3 x 35 in.	

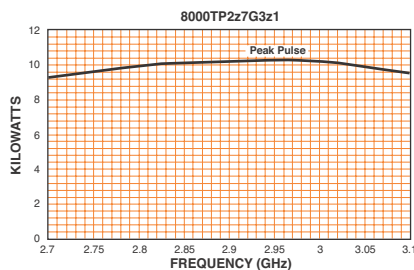

4000TP4G8

4 – 8 GHz
4000 W Pulse



Power (fundamental), Peak Pulse, @ Output	
Nominal	5000 W / min. 3.8 kW from 4 – 4.5 GHz, 4 kW from 4.5 – 7.5 GHz, 3.8 kW from 7.5 – 8 GHz
Flatness ±10 dB min.	
Frequency Response 4 – 8 GHz	
Input for Rated Output 1 milliwatt max.	
Gain (at max. setting) 66 dB min.	
Gain Adjustment (continuous range) 35 dB min.	
Input Impedance 50 ohms, VSWR 2.5:1 max.	
Output Impedance 50 ohms, VSWR 2.5:1 typ.	
Mismatch Tolerance Output pulse width foldback protection at peak reflected power exceeding 1000 W. Will operate without damage with any magnitude and phase of source and load impedance. May oscillate with unshielded open due to coupling to input. Should not be tested with connector off.	
Pulse Capability	
Pulse Width	07 – 50 microseconds
Pulse Rate (PRF)	100 kHz max.
Duty Cycle	4% max.
RF Rise and Fall	35 ns max. (10% to 90%)
Delay	300 ns max. from pulse input to RF 90%
Pulse Width Distortion	±50 ns max. (50% points of output pulse width compared to 50% points of input pulse width)
Pulse Off Isolation	80 dB min., 90 dB typ.
Pulse Input	TTL level, 50 ohm nominal termination

Noise Power Density	
(pulse on)	Minus 65 dBm/Hz max., Minus 75 dBm/Hz typ.
(pulse off)	Minus 140 dBm/Hz typ.
Harmonic Distortion Minus 0 dBc max (Base Model), –20 dBc max (S2K option installed and active)	
Primary Power 208 VAC ± 10% 50/60 Hz, three phase 2.5 kVA max.	
Connectors	
RF input	Type N female on rear panel
RF output	Type WRD–350 waveguide flange on rear panel
RF output forward sample port	Type N female on rear panel
Pulse input	Type BNC female on rear panel
Interlock	DB–15 female on rear panel
GPIB	IEEE–488 female on rear panel
Cooling Forced air (self-contained fans), air entry and exit in rear.	
Weight 71 kg (155 lb.)	
Size (WxHxD) See Model Configurations on spec sheet via www.arworld.us	

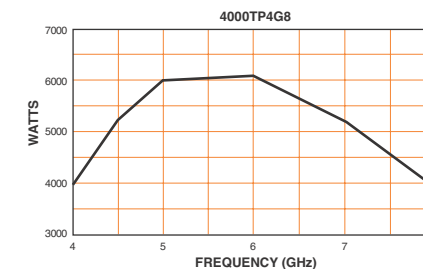

TWT Amplifiers

Frequency Range
2.5 – 50 GHz

Power Range
40 W – 20 kW

7400TP4G8 4 – 8 GHz 7400 W Pulse



Power (fundamental), Peak Pulse, @ Output	
Nominal	10000 W / min. 7,400 W
Flatness	±10 dB min., ±5 dB at rated power
Frequency Response	4 – 8 GHz
Input for Rated Output	1 milliwatt max.
Gain (at max. setting)	69 dB min.
Gain Adjustment (continuous range)	35 dB min.
Input Impedance	50 ohms, VSWR 2.5:1 max.
Output Impedance	50 ohms, VSWR 2.5:1 typ.

Mismatch Tolerance
Output pulse width foldback protection at peak reflected power exceeding 2000 W. Will operate without damage or oscillation with any magnitude and phase of source and load impedance. May oscillate with unshielded open due to coupling to input. Should not be tested with connector off.

Pulse Capability	
Pulse Width	0.2 – 50 microseconds
Pulse Rate (PRF)	100 kHz max.
Duty Cycle	4% max.
RF Rise and Fall	70 ns max. (10% – 90%)
Delay	500 ns max. from pulse input to RF 90%
Pulse Width Distortion	±50 ns max. (50% points of output pulse width compared to 50% points of input pulse width)
Pulse Off Isolation	80 dB min., 90 dB typ.
Pulse Input	TTL level, 50 ohm nominal termination

Noise Power Density	
(pulse on)	Minus 65 dBm/Hz max., Minus 85 dBm/Hz typ.
(pulse off)	Minus 140 dBm/Hz typ.

Harmonic Distortion	Minus 12 dBc typ.
Primary Power	208 VAC ± 10% 50/60 Hz, three phase, delta (4 wire) 5 kVA max.
Connectors	
RF input	Type N female on rear panel
RF output	Type WRD-350 waveguide flange on rear panel
RF output forward and reflected sample ports	Type N female on rear panel
Pulse input	Type BNC female on rear panel
Interlock	DB-15 female on rear panel
GPIB	IEEE-488 female on rear panel
Cooling	Forced air (self-contained fans), air entry and exit in rear.
Weight	123 kg (270 lb.)
Size (WxHxD)	50.3 x 53 x 91 cm / 19.8 x 24 x 36 in.

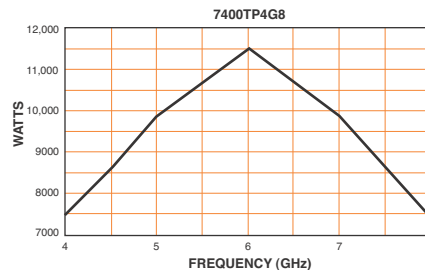

1000TP8G18 7.5 – 18 GHz 1000 W Pulse



Power (fundamental), Peak Pulse, @ Output Connector	
Nominal	1,800 W / min. 1000 W
Flatness	±8 dB max., equalized for ±3 dB max. at rated power
Frequency Response	7.5 – 18 GHz instantaneously
Input for Rated Output	1 milliwatt max.
Gain (at max. setting)	60 dB min.
Gain Adjustment (continuous range)	35 dB min.
Input Impedance	50 ohms, VSWR 2.5:1 max.
Output Impedance	50 ohms, VSWR 2.5:1 typ.

Mismatch Tolerance
Output pulse width foldback protection at peak reflected power exceeding 500 W. Will operate without damage or oscillation with any magnitude and phase of source and load impedance. May oscillate with unshielded open due to coupling to input. Should not be tested with connector off.

Pulse Capability	
Pulse Width	07 – 100 microseconds
Pulse Rate (PRF)	100 kHz max.
Duty Cycle	4% max.
RF Rise and Fall	30 ns max. (10% – 90%)
Delay	300 ns max. from pulse input to RF 90%
Pulse Width Distortion	±30 ns max. (50% points of output pulse width compared to 50% points of input pulse width)
Pulse Off Isolation	80 dB min. / 90 dB typ.
Pulse Input	TTL level, 50 ohm nominal termination

Noise Power Density	
(pulse on)	Minus 57 dBm/Hz max., Minus 58 dBm/Hz typ.
(pulse off)	Minus 140 dBm/Hz typ.

Harmonic Distortion	Minus 2 dBc max., Minus 3 dBc typ.
Primary Power	190 – 260 VAC 50/60 Hz, single phase 1.5 kVA max.
Connectors	
RF input	Type N female on rear panel
RF output	Type WRD-750D24 waveguide flange on rear panel
RF output forward sample port	Type N female on rear panel
Pulse input	Type BNC female on rear panel
Interlock	DB-15 female on rear panel
GPIB	IEEE-488 female on rear panel
Cooling	Forced air (self-contained fans), air entry and exit in rear.
Weight	52 kg (115 lb.)
Size (WxHxD)	50.3 x 25.4 x 69 cm / 19.8 x 10 x 27 in.
Export Classification	3A999.d

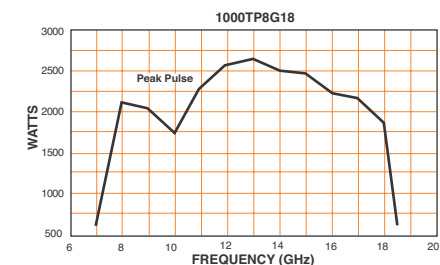

TWT Amplifiers

Frequency Range
2.5 – 50 GHz

Power Range
40 W – 20 kW

2000TP8G18 7.5 – 18 GHz 2000 W Pulse



Power (fundamental), Peak Pulse, @ Output Connector	
Nominal	2,500 W / min. 2000 W
Flatness	±8 dB max., equalized for ±3 dB max. at rated power
Frequency Response	7.5 – 18 GHz instantaneously
Input for Rated Output	1 milliwatt max.
Gain (at max. setting)	63 dB min.
Gain Adjustment (continuous range)	35 dB min.
Input Impedance	50 ohms, VSWR 2.5:1 max.
Output Impedance	50 ohms, VSWR 2.5:1 typ.

Mismatch Tolerance
Output pulse width foldback protection at average reflected power exceeding 1000 W. Will operate without damage or oscillation with any magnitude and phase of source and load impedance. May oscillate with unshielded open due to coupling to input. Should not be tested with connector off.

Pulse Capability	
Pulse Width	07 – 30 microseconds
Pulse Rate (PRF)	100 kHz max.
Duty Cycle	4% max.
RF Rise and Fall	30 ns max (10% – 90%)
Delay	300 ns max. from pulse input to RF 90%
Pulse Width Distortion	±30 ns max (50% points of output pulse width compared to 50% points of input pulse width)
Pulse Off Isolation	80 dB min. / 90 dB typ.
Pulse Input	TTL level, 50 ohm nominal termination

Noise Power Density	
(pulse on)	Minus 55 dBm/Hz max., Minus 58 dBm/Hz typ.
(pulse off)	Minus 140 dBm/Hz typ.

Harmonic Distortion	Minus 18 dBc max., Minus 20 dBc typ.
Primary Power	190 – 260 VAC 50/60 Hz, single phase 3 kVA max.

Connectors	
RF input	Type N female on rear panel
RF output	Type WRD-750D24 waveguide flange on rear panel
RF output forward sample port	Type N female on rear panel
Pulse input	Type BNC female on rear panel
Interlock	DB-15 female on rear panel
GPIB	IEEE-488 female on rear panel

Cooling
Forced air (self-contained fans), air entry and exit in rear.

Weight 72 kg (170 lb.)

Size (WxHxD) 50.3. x 39.4 x 77.5 cm / 19.8 x 15.5 x 30.5 in.

Export Classification 3A999.d

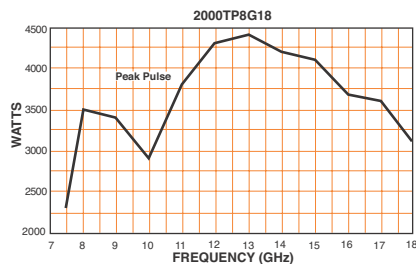

4000TP8G12 8 – 12 GHz 4000 W Pulse



Power (fundamental), Peak Pulse, @ Output	
Nominal	5,500 W / min. 4,200 W
Flatness	±10 dB max.
Frequency Response	8 – 12 GHz
Input for Rated Output	1 milliwatt max.
Gain (at max. setting)	66 dB min.
Gain Adjustment (continuous range)	35 dB min.
Input Impedance	50 ohms, VSWR 2.5:1 max.
Output Impedance	50 ohms, VSWR 2.5:1 typ.

Mismatch Tolerance
Output pulse width foldback protection at peak reflected power exceeding 1000 W. Will operate without damage with any magnitude and phase of source and load impedance. May oscillate with unshielded open due to coupling to input. Should not be tested with connector off.

Pulse Capability	
Pulse Width	07 – 50 microseconds
Pulse Rate (PRF)	100 kHz max.
Duty Cycle	4% max.
RF Rise and Fall	35 ns max. (10% – 90%)
Delay	300 ns max. from pulse input to RF 90%
Pulse Width Distortion	±50 ns max. (50% points of output pulse width compared to 50% points of input pulse width)
Pulse Off Isolation	80 dB min., 90 dB typ.
Pulse Input	TTL level, 50 ohm nominal termination

Noise Power Density	
(pulse on)	Minus 57 dBm/Hz max., Minus 59 dBm/Hz typ.
(pulse off)	Minus 140 dBm/Hz typ.

Harmonic Distortion	Minus 10 dBc max.
Primary Power	208 VAC ± 10% or 190 – 260 VAC 50/60 Hz, three phase or single phase 3 kVA max.

Connectors	
RF input	Type N female on rear panel
RF output	Type WRD-90 waveguide flange on rear panel
RF output forward sample port	Type N female on rear panel
Pulse input	Type BNC female on rear panel
Interlock	DB-15 female on rear panel
GPIB	IEEE-488 female on rear panel

Cooling
Forced air (self-contained fans), air entry and exit in rear.

Weight 75 kg (165 lb.)

Size (WxHxD) 51 x 44.5 x 69 cm / 19.8 x 17.5 x 27 in.

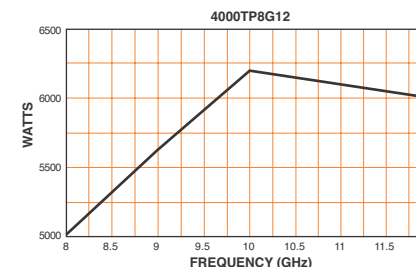

TWT Amplifiers

Frequency Range
2.5 – 50 GHz

Power Range
40 W – 20 kW

8300TP8G12 8 – 12 GHz 8300 W Pulse



Power (fundamental), Peak Pulse, @ Output	
Nominal	10000 W / min. 8,300 W
Flatness	±10 dB max., ±5 dB at rated power
Frequency Response	8 – 12 GHz
Input for Rated Output	1 milliwatt max.
Gain (at max. setting)	69 dB min.
Gain Adjustment (continuous range)	35 dB min.
Input Impedance	50 ohms, VSWR 2.5:1 max.
Output Impedance	50 ohms, VSWR 2.5:1 typ.

Mismatch Tolerance
Output pulse width foldback protection at peak reflected power exceeding 4000 W. Will operate without damage or oscillation with any magnitude and phase of source and load impedance. May oscillate with unshielded open due to coupling to input. Should not be tested with connector off.

Pulse Capability	
Pulse Width	0.2 – 50 microseconds
Pulse Rate (PRF)	100 kHz max.
Duty Cycle	4% max.
RF Rise and Fall	70 ns max. (10% – 90%)
Delay	500 ns max. from pulse input to RF 90%
Pulse Width Distortion	±50 ns max. (50% points of output pulse width compared to 50% points of input pulse width)
Pulse Off Isolation	80 dB min., 90 dB typ.
Pulse Input	TTL level, 50 ohm nominal termination

Noise Power Density	
(pulse on)	Minus 70 dBm/Hz max., Minus 73 dBm/Hz typ.
(pulse off)	Minus 140 dBm/Hz typ.

Harmonic Distortion	Minus 15 dBc max.
Primary Power	208 VAC ± 10% 50/60 Hz, three phase, delta (4 wire) 5 kVA max.
Connectors	
RF input	Type N precision female on rear panel
RF output	Type WR-90 waveguide flange on rear panel
RF output forward and reflected sample ports	Type N precision female on rear panel
Pulse input	Type BNC female on rear panel
Interlock	DB-15 female on rear panel
GPIB	IEEE-488 female on rear panel

Cooling
Forced air (self-contained fans), air entry and exit in rear.

Weight 121 kg (265 lb.)

Size (WxHxD) 50.3 x 43 x 84 cm / 19.8 x 17 x 33 in.

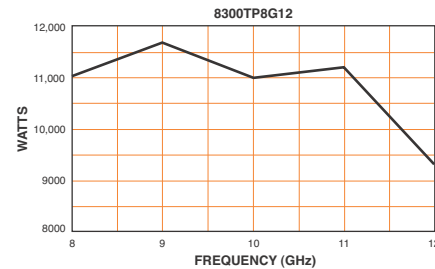

20000TP8G12 8 – 12 GHz 20000 W Pulse



Power (fundamental), Peak Pulse, @ Output	
Nominal	22000 W / min. 20000 W
Flatness	±10 dB max., ±6 dB at rated power
Frequency Response	8 – 12 GHz
Input for Rated Output	1 milliwatt max.
Gain (at max. setting)	73 dB min.
Gain Adjustment (continuous range)	35 dB min.
Input Impedance	50 ohms, VSWR 2.5:1 max.
Output Impedance	50 ohms, VSWR 2.5:1 typ.

Mismatch Tolerance
Output pulse width foldback protection at peak reflected power exceeding 5000 W. Will operate without damage or oscillation with any magnitude and phase of source and load impedance. May oscillate with unshielded open due to coupling to input. Should not be tested with connector off.

Pulse Capability	
Pulse Width	0.1 – 40 microseconds
Pulse Rate (PRF)	20 kHz max.
Duty Cycle	4% max.
RF Rise and Fall	150 ns max. (10% – 90%)
Delay	500 ns max. from pulse input to RF 90%
Pulse Width Distortion	±50 ns max. (50% points of output pulse width compared to 50% points of input pulse width)
Pulse Off Isolation	80 dB min., 90 dB typ.
Pulse Input	TTL level, 50 ohm nominal termination

Noise Power Density	
(pulse on)	Minus 65 dBm/Hz max., Minus 85 dBm/Hz typ.
(pulse off)	Minus 140 dBm/Hz typ.

Harmonic Distortion	Minus 19 dBc max.
Primary Power	208 VAC ±10% Three phase, delta (4-wire), 50/60 Hz 12 kVA max.
Connectors	
RF input	Type N female on rear panel
RF output	Type WRD-90 female on rear panel
RF output forward sample ports (forward and reflected)	Type N female on rear panel
Pulse input	Type BNC female on rear panel
Interlock	DB-15 female on rear panel
GPIB	IEEE-488 female on rear panel

Cooling
Forced air (self-contained fans), air entry and exit in rear.

Weight 575 kg (1,250 lb.)

Size (WxHxD) 57.5 x 196 x 82.5 cm / 22.6 x 77.2 x 32.5 in.

Export Classification 3A999.d

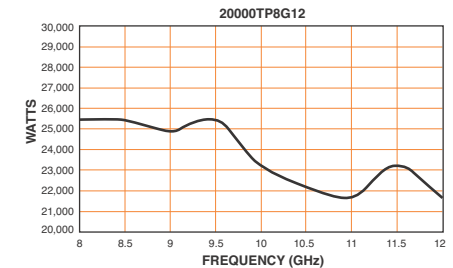

TWT Amplifiers

Frequency Range
2.5 – 50 GHz

Power Range
40 W – 20 kW

3000TP12G18 12 – 18 GHz 3000 W Pulse



Power (fundamental), Peak Pulse, @ Output	
Nominal	3,800 W / min. 3000 W
Flatness	±10 dB max.
Frequency Response	12 – 18 GHz
Input for Rated Output	1 milliwatt max.
Gain (at max. setting)	65 dB min.
Gain Adjustment (continuous range)	35 dB min.
Input Impedance	50 ohms, VSWR 2.5:1 max.
Output Impedance	50 ohms, VSWR 2.5:1 typ.

Mismatch Tolerance
Output pulse width foldback protection at peak reflected power exceeding 1000 W. Will operate without damage with any magnitude and phase of source and load impedance. May oscillate with unshielded open due to coupling to input. Should not be tested with connector off.

Pulse Capability	
Pulse Width	07 – 50 microseconds
Pulse Rate (PRF)	100 kHz max.
Duty Cycle	4% max.
RF Rise and Fall	30 ns max. (10% – 90%)
Delay	300 ns max. from pulse input to RF 90%
Pulse Width Distortion	±30 ns max. (50% points of output pulse width compared to 50% points of input pulse width)
Pulse Off Isolation	80 dB min., 90 dB typ.
Pulse Input	TTL level, 50 ohm nominal termination

Noise Power Density	
(pulse on)	Minus 55 dBm/Hz max., Minus 65 dBm/Hz typ.
(pulse off)	Minus 140 dBm/Hz typ.

Harmonic Distortion	Minus 8 dBc max.
Primary Power	190 – 260 VAC 50/60 Hz, single phase 2 kVA max.
Connectors	
RF input	Type N female on rear panel
RF output	Type WR-62 waveguide flange on rear panel
RF output forward sample port	
Pulse input	Type N female on rear panel
Interlock	Type BNC female on rear panel
GPIO	DB-15 female on rear panel
GPIO	IEEE-488 female on rear panel

Cooling
Forced air (self-contained fans), air entry and exit in rear.

Weight 52 kg (115 lb.)

Size (WxHxD) 50.3 x 26 x 81 cm / 19.8 x 10 x 31.9 in.

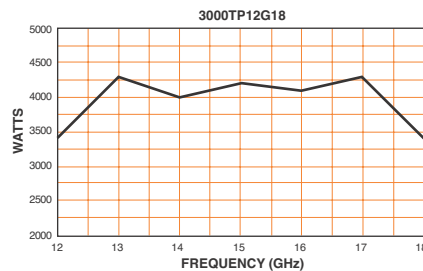

5700TP12G18 12 – 18 GHz 5700 W Pulse



Power (fundamental), Peak Pulse, @ Output	
Nominal	7000 W / min. 5700 W
Flatness	±10 dB min., ±5 dB at rated power
Frequency Response	12 – 18 GHz
Input for Rated Output	1 milliwatt max.
Gain (at max. setting)	67 dB min.
Gain Adjustment (continuous range)	35 dB min.
Input Impedance	50 ohms, VSWR 2.5:1 max.
Output Impedance	50 ohms, VSWR 2.5:1 typ.

Mismatch Tolerance
Output pulse width foldback protection at peak reflected power exceeding 3000 W. Will operate without damage or oscillation with any magnitude and phase of source and load impedance. May oscillate with unshielded open due to coupling to input. Should not be tested with connector off.

Pulse Capability	
Pulse Width	0.2 – 50 microseconds
Pulse Rate (PRF)	100 kHz max.
Duty Cycle	4% max.
RF Rise and Fall	70 ns max. (10% – 90%)
Delay	500 ns max. from pulse input to RF 90%
Pulse Width Distortion	±50 ns max. (50% points of output pulse width compared to 50% points of input pulse width)
Pulse Off Isolation	80 dB min., 90 dB typ.
Pulse Input	TTL level, 50 ohm nominal termination

Noise Power Density	
(pulse on)	Minus 55 dBm/Hz max., Minus 80 dBm/Hz typ.
(pulse off)	Minus 140 dBm/Hz typ.

Harmonic Distortion	Minus 15 dBc max.
Primary Power	208 ±10% VAC 50/60 Hz, three phase, delta (4 wire) 5 kVA max.
Connectors	
RF input	Type N precision female on rear panel
RF output	Type WR-62 waveguide flange on rear panel
RF output forward and reflected sample ports	
Pulse input	Type N precision female on rear panel
Interlock	Type BNC female on rear panel
GPIO	DB-15 female on rear panel
GPIO	IEEE-488 female on rear panel

Cooling
Forced air (self-contained fans), air entry and exit in rear.

Weight 121 kg (265 lb.)

Size (WxHxD) 50.3 x 43 x 84 cm / 19.8 x 17 x 33 in.

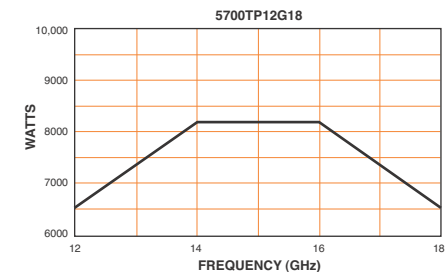

Systems

Test systems by AR can deliver a solution that integrates all your testing needs for radiated and conducted immunity, radiated and conducted emissions, and more. With a highly experienced team, we have the expertise to supply fully automated systems needed to test various EMC standards.



SSIEC3V3M

3 V/m field strength with up to a 3 meter test distance from 80 MHz – 6 GHz

System Frequency Range	80 MHz – 6 GHz
CW Field Strength	5.4 V/m (3 V/m w/ 80% AM per IEC 61000-4-3)
Test Distance	Up to 3 meters
UFA	1.5 x 1.5 meters per IEC 61000-4-3

Amplifier Configuration	Models: 50W1000D, 50 W, 50 - 1000 MHz; 15S1G6, 15 W, 700 MHz - 6 GHz
-------------------------	---

Antenna Configuration	Models: ATR80M6G, Log-Periodic, 80 MHz - 6 GHz; ATT700M2G, Log-Periodic, 700 MHz - 12 GHz
-----------------------	--

RF Cable Configuration	Two sets (one for each amp/antenna) consisting of 2 and 5 meter lengths and designated bulkhead feedthroughs for each set.
------------------------	--

Software Configuration	System and testing will be controlled using emcware® software which is preloaded and delivered on a new PC as part of overall system. Price includes a 1-year support contract.
------------------------	---

Design approach	Self-contained equipment rack with internal pre-wired RF and power with automatic RF switching via SCP2000. AC power is filtered and distributed through an internal power distribution unit. All RF equipment input and outputs are on rear-panel of devices.
-----------------	--

Installation, Site Acceptance Testing (SAT) and Training	One week of installation, SAT and Training will be provided by AR Systems Engineers.
--	--

Export Classification	EAR99
-----------------------	-------

SSIEC10V2M

10 V/m field strength with up to a 2 meter test distance from 80 MHz – 6 GHz

System Frequency Range	80 MHz – 6 GHz
CW Field Strength	18 V/m (10 V/m w/ 80% AM per IEC 61000-4-3)
Test Distance	Up to 2 meters
UFA	1.5 x 1.5 meters per IEC 61000-4-3

Amplifier Configuration	Models: 125W1000A, 50 W, 80 - 1000 MHz; 30S1G6C, 30 W, 1 - 6 GHz
-------------------------	---

Antenna Configuration	Models: ATR80M6G, Log-Periodic, 80 MHz - 6 GHz; ATT700M12G, Log-Periodic, 700 MHz - 12 GHz
-----------------------	---

RF Cable Configuration	Two sets (one for each amp/antenna) consisting of 2 and 5 meter lengths and designated bulkhead feedthroughs for each set.
------------------------	--

Software Configuration	System and testing will be controlled using emcware® software which is preloaded and delivered on a new PC as part of overall system. Price includes a 1-year support contract.
------------------------	---

Design approach	Self-contained equipment rack with internal pre-wired RF and power with automatic RF switching via SCP2000. AC power is filtered and distributed through an internal power distribution unit. All RF equipment input and outputs are on rear-panel of devices.
-----------------	--

Installation, Site Acceptance Testing (SAT) and Training	One week of installation, SAT and Training will be provided by AR Systems Engineers.
--	--

Export Classification	EAR99
-----------------------	-------

SSIEC10V3M

10 V/m field strength with up to a 3 meter test distance from 80 MHz – 6 GHz

System Frequency Range	80 MHz – 6 GHz
CW Field Strength	18 V/m (10 V/m w/ 80% AM per IEC 61000-4-3)
Test Distance	Up to 3 meters
UFA	1.5 x 1.5 meters per IEC 61000-4-3

Amplifier Configuration	Models: 150W1000B, 150 W, 80 - 1000 MHz; 75S1G6C, 75 W, 1 - 6 GHz
-------------------------	--

Antenna Configuration	Models: ATR80M6G, Log-Periodic, 80 MHz - 6 GHz; ATT700M12G, Log-Periodic, 700 MHz - 12 GHz
-----------------------	---

RF Cable Configuration	Two sets (one for each amp/antenna) consisting of 2 and 5 meter lengths and designated bulkhead feedthroughs for each set.
------------------------	--

Software Configuration	System and testing will be controlled using emcware® software which is preloaded and delivered on a new PC as part of overall system. Price includes a 1-year support contract.
------------------------	---

Design approach	Self-contained equipment rack with internal pre-wired RF and power with automatic RF switching via SCP2000. AC power is filtered and distributed through an internal power distribution unit. All RF equipment input and outputs are on rear-panel of devices.
-----------------	--

Installation, Site Acceptance Testing (SAT) and Training	One week of installation, SAT and Training will be provided by AR Systems Engineers.
--	--

Export Classification	3A001
-----------------------	-------

SSIEC30V2M

30 V/m field strength with up to a 2 meter test distance from 80 MHz – 6 GHz

System Frequency Range	80 MHz – 6 GHz
CW Field Strength	54 V/m (30 V/m w/ 80% AM per IEC 61000-4-3)
Test Distance	Up to 2 meters
UFA	1.5 x 1.5 meters per IEC 61000-4-3

Amplifier Configuration	Models: 500W1000C, 500 W, 80 - 1000 MHz; 250S1G6C, 125 W, 1 - 6 GHz
-------------------------	--

Antenna Configuration	Models: ATR80M6G, Log-Periodic, 80 MHz - 6 GHz; ATT700M12G, Log-Periodic, 700 MHz - 12 GHz
-----------------------	---

RF Cable Configuration	Two sets (one for each amp/antenna) consisting of 2 and 5 meter lengths and designated bulkhead feedthroughs for each set.
------------------------	--

Software Configuration	System and testing will be controlled using emcware® software which is preloaded and delivered on a new PC as part of overall system. Price includes a 1-year support contract.
------------------------	---

Design approach	Self-contained equipment rack with internal pre-wired RF and power with automatic RF switching via SCP2000. AC power is filtered and distributed through an internal power distribution unit. All RF equipment input and outputs are on rear-panel of devices.
-----------------	--

Installation, Site Acceptance Testing (SAT) and Training	One week of installation, SAT and Training will be provided by AR Systems Engineers.
--	--

Export Classification	3A001
-----------------------	-------

SSIEC30V3M

30 V/m field strength
with up to a 3 meter test
distance from
80 MHz – 6 GHz

System Frequency Range 80 MHz – 6 GHz

CW Field Strength 54 V/m (30 V/m w/ 80% AM per IEC 61000-4-3)

Test Distance Up to 3 meters

UFA 1.5 x 1.5 meters per IEC 61000-4-3

Amplifier Configuration

Models: 750W1000B, 750 W, 80 - 1000 MHz;
500S1G6C, 500 W, 1 - 6 GHz

Antenna Configuration

Models: ATR80M6G, Log-Periodic, 80 MHz - 6 GHz;
ATT700M12G, Log-Periodic, 700 MHz - 12 GHz

RF Cable Configuration

Two sets (one for each amp/antenna) consisting of 2 and 5
meter lengths and designated bulkhead feedthroughs for each set.

Software Configuration

System and testing will be controlled using emcware® software
which is preloaded and delivered on a new PC as part of overall
system. Price includes a 1-year support contract.

Design approach

Self-contained equipment rack with internal pre-wired RF and
power with automatic RF switching via SCP2000. AC power is
filtered and distributed through an internal power distribution
unit. All RF equipment input and outputs are on rear-panel of devices.

Installation, Site Acceptance Testing (SAT) and Training

One week of installation, SAT and Training will be provided by
AR Systems Engineers

Export Classification 3A001

SSISOV50V10K18G

50 V/m field strength for
full vehicle testing from
10 kHz – 18 GHz

System Frequency Range 10kHz – 18 GHz

CW Field Strength

50 V/m (50 V/m w/ 80% AM peak conservation per ISO 11451-1)

Test Distance 2 meters

Field Probe Configuration 1 FL8200 and 4 FL8018 Field Probes

UFA 0.5 meters on each side of reference point per ISO 11451-2

Amplifier Configuration

Models: 2500A225B, 2500 W, 10 kHz - 225 MHz;
500W1000C, 500 W, 80 - 1000 MHz;
250S1G6C, 250 W, 1 - 6 GHz;
250T6G18, 250 W, 6 - 18 GHz

Antenna Configuration

Models: FSA S35012-41 Stripline, 10 kHz - 30 MHz;
FSA S12014-5, Log-Periodic, 20 - 220 MHz;
ATH200M2G, Horn, 200 - 2000 MHz;
ATH800M6G, Horn, 800 - 6000 MHz;
ATH6G18A, Horn, 6 - 18 GHz

RF Cable Configuration

Four sets (one for each amp/antenna) consisting of 2 and 12
meter lengths and designated bulkhead feedthroughs for each set.

Software Configuration

System and testing will be controlled using emcware® software
which is preloaded and delivered on a new PC as part of overall
system. Price includes a 1-year support contract.

Design approach

Self-contained equipment rack with internal pre-wired RF and
power with automatic RF switching via SCP2000. AC power is
filtered and distributed through an internal power distribution
unit. All RF equipment input and outputs are on rear-panel of devices.

Installation, Site Acceptance Testing (SAT) and Training

One week of installation, SAT and Training will be provided by
AR Systems Engineers.

Export Classification 3A001

SSISOV50V20M18G

50 V/m field strength for
full vehicle testing from
20 MHz – 18 GHz

System Frequency Range 20MHz – 18 GHz

CW Field Strength

50 V/m (50 V/m w/ 80% AM peak conservation per ISO 11451-1)

Test Distance 2 meters

Field Probe Configuration 4 FL8018 Field Probes

UFA 0.5 meters on each side of reference point per ISO 11451-2

Amplifier Configuration

Models: 2500A225A, 2500 W, 10 kHz - 225 MHz;
500W1000C, 500 W, 80 - 1000 MHz;
250S1G6C, 250 W, 1 - 6 GHz;
250T6G18, 250 W, 6 - 18 GHz

Antenna Configuration

Models: FSA S12014-5, Log-Periodic, 20 - 220 MHz;
ATH200M2G, Horn, 200 - 2000 MHz;
ATH800M6G, Horn, 800 - 6000 MHz;
ATH6G18A, Horn, 6 - 18 GHz

RF Cable Configuration

Four sets (one for each amp/antenna) consisting of 2 and 12
meter lengths and designated bulkhead feedthroughs for each set.

Software Configuration

System and testing will be controlled using emcware® software
which is preloaded and delivered on a new PC as part of overall
system. Price includes a 1-year support contract.

Design approach

Self-contained equipment rack with internal pre-wired RF and
power with automatic RF switching via SCP2000. AC power is
filtered and distributed through an internal power distribution
unit. All RF equipment input and outputs are on rear-panel of devices.

Installation, Site Acceptance Testing (SAT) and Training

One week of installation, SAT and Training will be provided by
AR Systems Engineers.

Export Classification 3A001

SSISOV100V10K18G

100 V/m field strength
for full vehicle testing
from 10 kHz – 18 GHz

System Frequency Range 10kHz – 18 GHz

CW Field Strength

100 V/m (100 V/m w/ 80% AM peak conservation per ISO 11451-1)

Test Distance 2 meters

Field Probe Configuration 1 FL8200 and 4 FL8018 Field Probes

UFA 0.5 meters on each side of reference point per ISO 11451-2

Amplifier Configuration

Models: 10000A225B, 10000 W, 10 kHz - 225 MHz;
500W1000C, 500 W, 80 - 1000 MHz;
250S1G6C, 250 W, 1 - 6 GHz;
250T6G18, 250 W, 6 - 18 GHz

Antenna Configuration

Models: FSA S35012-41, Stripline, 10 kHz - 30 MHz
FSA S12014-5, Log-Periodic, 20 - 220 MHz;
ATH200M2G, Horn, 200 - 2000 MHz;
ATH800M6G, Horn, 800 - 6000 MHz;
ATH6G18A, Horn, 6 - 18 GHz

RF Cable Configuration

Four sets (one for each amp/antenna) consisting of 2 and 12
meter lengths and designated bulkhead feedthroughs for each set.

Software Configuration

System and testing will be controlled using emcware® software
which is preloaded and delivered on a new PC as part of overall
system. Price includes a 1-year support contract.

Design approach

Self-contained equipment rack with internal pre-wired RF and
power with automatic RF switching via SCP2000. AC power is
filtered and distributed through an internal power distribution
unit. All RF equipment input and outputs are on rear-panel of devices.

Installation, Site Acceptance Testing (SAT) and Training

One week of installation, SAT and Training will be provided by
AR Systems Engineers.

Export Classification 3A001

SSISOV100V20M18G 100 V/m field strength for full vehicle testing from 80 MHz-18 GHz

System Frequency Range	20 MHz – 18 GHz
CW Field Strength	100 V/m (100 V/m w/ 80% AM peak conservation per ISO 11451-1)
Test Distance	2 meters
Field Probe Configuration	4 FL8018 Field Probes
UFA	0.5 meters on each side of reference point per ISO 11451-2
Amplifier Configuration	Models: 10000A225B, 10000 W, 10 kHz - 225 MHz; 500W1000C, 500 W, 80 - 1000 MHz; 250S1G6C, 250 W, 1 - 6 GHz; 250T6G18, 250 W, 6 - 18 GHz
Antenna Configuration	Models: FSA S12014-5, Log-Periodic, 20 - 220 MHz; ATH200M2G, Horn, 200 - 2000 MHz; ATH800M6G, Horn, 800 - 6000 MHz; ATH6G18A, Horn, 6 - 18 GHz
RF Cable Configuration	Four sets (one for each amp/antenna) consisting of 2 and 12 meter lengths and designated bulkhead feedthroughs for each set.
Software Configuration	System and testing will be controlled using emcware [®] software which is preloaded and delivered on a new PC as part of overall system. Price includes a 1-year support contract.
Design approach	Self-contained equipment rack with internal pre-wired RF and power with automatic RF switching via SCP2000. AC power is filtered and distributed through an internal power distribution unit. All RF equipment input and outputs are on rear-panel of devices.
Installation, Site Acceptance Testing (SAT) and Training	One week of installation, SAT and Training will be provided by AR Systems Engineers.
Export Classification	3A001

SSISOV200V10K18G 200 V/m field strength for full vehicle testing from 10 kHz – 18 GHz

System Frequency Range	10 kHz – 18 GHz
CW Field Strength	200 V/m (200 V/m w/ 80% AM peak conservation per ISO 11451-1)
Test Distance	2 meters
Field Probe Configuration	1 FL8200 and 4 FL8018 Field Probes
UFA	0.5 meters on each side of reference point per ISO 11451-2
Amplifier Configuration	Models: 10000A225B, 10000 W, 10 kHz - 225 MHz; 2000W10000D, 2000 W, 80 - 1000 MHz; 500S1G6C, 500 W, 1 - 6 GHz; 200T4G8, 200 W, 4 - 8 GHz; 250T8G18, 250 W, 7.5 - 18 GHz
Antenna Configuration	Models: FSA S35012-41, Stripline, 10 kHz - 30 MHz; FSA S12018-21, Log-Periodic, 20 - 100 MHz; ATL80M1G, Log-Periodic, 80 - 1000 MHz; ATH200M1G, Horn, 200 - 1000 MHz; ATH800M6G, Horn, 800 - 6000 MHz; ATH4G8, Horn, 4 - 8 GHz; ATH7G18, Horn, 7.5 - 18 GHz
RF Cable Configuration	Five sets (one for each amp/antenna) consisting of 2 and 8 meter lengths and designated bulkhead feedthroughs for each set.
Software Configuration	System and testing will be controlled using emcware [®] software which is preloaded and delivered on a new PC as part of overall system. Price includes a 1-year support contract.
Design approach	Self-contained equipment rack with internal pre-wired RF and power with automatic RF switching via SCP2000. AC power is filtered and distributed through an internal power distribution unit. All RF equipment inputs and outputs are on rear-panel of devices.
Installation, Site Acceptance Testing (SAT) and Training	One week of installation, SAT and Training will be provided by AR Systems Engineers.
Export Classification	3A001

SSISOV200V30M18G 200 V/m field strength for full vehicle testing from 30 MHz – 18 GHz

System Frequency Range	30 MHz – 18 GHz
CW Field Strength	200 V/m (200 V/m w/ 80% AM peak conservation per ISO 11451-1)
Test Distance	2 meters
Field Probe Configuration	4 FL8018 Field Probes
UFA	0.5 meters on each side of reference point per ISO 11451-2
Amplifier Configuration	Models: 10000A225B, 10000 W, 10 kHz - 225 MHz; 2000W1000D, 2000 W, 80 - 1000 MHz; 500S1G6C, 500 W, 1 - 6 GHz; 200T4G8, 200 W, 4 - 8 GHz; 250T8G18, 250 W, 7.5 - 18 GHz
Antenna Configuration	Models: FSA S12018-21, Log-Periodic, 20 - 100 MHz; ATL80M1G, Log-Periodic, 80 - 1000 MHz; ATH200M1G, Horn, 200 - 1000 MHz; ATH800M6G, Horn, 800 - 6000 MHz; ATG4G8, Horn, 4 - 8 GHz; ATH7G18, Horn, 7.5 - 18 GHz
RF Cable Configuration	Five sets (one for each amp/antenna) consisting of 2 and 8 meter lengths and designated bulkhead feedthroughs for each set.
Software Configuration	System and testing will be controlled using emcware [®] software which is preloaded and delivered on a new PC as part of overall system. Price includes a 1-year support contract.
Design approach	Self-contained equipment rack with internal pre-wired RF and power with automatic RF switching via SCP2000. AC power is filtered and distributed through an internal power distribution unit. All RF equipment input and outputs are on rear-panel of devices.
Installation, Site Acceptance Testing (SAT) and Training	One week of installation, SAT and Training will be provided by AR Systems Engineers.
Export Classification	3A001

SSISOC50V10K18G 50 V/m field strength for vehicle component testing from 10 kHz – 18 GHz

System Frequency Range	10 kHz – 18 GHz
CW Field Strength	50 V/m (50 V/m w/ 80% AM peak conservation per ISO 11452-1)
Test Distance	1 meter
Amplifier Configuration	Models: 100A400A, 100 W, 10 kHz - 400 MHz; 250W1000C, 250 W, 80 - 1000 MHz; 75S1G6C, 75 W, 1 - 6 GHz; 75S6G18C, 75 W, 6 - 18 GHz
Antenna Configuration	Models: Schwarzbeck TEMZ 5232 or equivalent, Stripline, DC - 1000 MHz; ATR80M6G, Log-Periodic, 80 MHz - 6 GHz; DRH-118, Horn, 1 - 18 GHz
RF Cable Configuration	Four sets (one for each amp/antenna) consisting of 2 and 5 meter lengths and designated bulkhead feedthroughs for each set.
Software Configuration	System and testing will be controlled using emcware [®] software which is preloaded and delivered on a new laptop as part of overall system. Price includes a 1 year support contract.
Design approach	Self-contained equipment rack with internal pre-wired RF and power with automatic RF switching via SCP2000. AC power is filtered and distributed through an internal power distribution unit. All RF equipment input and outputs are on rear-panel of devices.
Installation, Site Acceptance Testing (SAT) and Training	One week of installation, SAT and Training will be provided by AR Systems Engineers.
Export Classification	3A001

SSISOC50V80M18G

50 V/m field strength for vehicle component testing from 80 MHz – 18 GHz

System Frequency Range 80MHz – 18 GHz

CW Field Strength 50 V/m (50 V/m w/ 80% AM peak conservation per ISO 11452-1)

Test Distance 1 meter

Amplifier Configuration

Models: 250W1000C, 250 W, 80 - 1000 MHz;
75S1G6C, 75 W, 1 - 6 GHz;
75S6G18C, 75 W, 6 - 18 GHz

Antenna Configuration

Models: ATR80M6G, Log-Periodic, 80 MHz - 6 GHz;
DRH-118, Horn, 1 - 18 GHz

RF Cable Configuration

Two sets (one for each amp/antenna) consisting of 2 and 5 meter lengths and designated bulkhead feedthroughs for each set.

Software Configuration

System and testing will be controlled using emcware® software which is preloaded and delivered on a new laptop as part of overall system. Price includes a 1 year support contract.

Design approach

Self-contained equipment rack with internal pre-wired RF and power with automatic RF switching via SCP2000. AC power is filtered and distributed through an internal power distribution unit. All RF equipment input and outputs are on rear-panel of devices.

Installation, Site Acceptance Testing (SAT) and Training

One week of installation, SAT and Training will be provided by AR Systems Engineers.

Export Classification 3A001

SSISOC100V10K18G

100 V/m field strength for vehicle component testing from 10 kHz – 18 GHz

System Frequency Range 10 kHz – 18 GHz

CW Field Strength 100 V/m (100 V/m w/ 80% AM peak conservation per ISO 11452-1)

Test Distance 1 meter

Amplifier Configuration

Models: 100A400A, 100 W, 10 kHz - 400 MHz;
2500A225A, 2500 W, 10 kHz - 225 MHz;
500W1000c, 500 W, 80 - 1000 MHz;
125S1G6C, 125 W, 1 - 6 GHz;
40S6G18C 40 W, 6 - 18 GHz

Antenna Configuration

Models: Schwarzbeck TEMZ 5232 or equivalent,
Stripline, DC - 1000 MHz;
ATR80M6G, Log-Periodic, 80 MHz - 6 GHz;
ATH800M6G, Horn, 1 - 6 GHz;
ATH6G18A, Horn, 6 - 18 GHz

RF Cable Configuration

Two sets (one for each amp/antenna) consisting of 2 and 5 meter lengths and designated bulkhead feedthroughs for each set.

Software Configuration

System and testing will be controlled using emcware® software which is preloaded and delivered on a new laptop as part of overall system. Price includes a 1 year support contract.

Design approach

Self-contained equipment rack with internal pre-wired RF and power with automatic RF switching via SCP2000. AC power is filtered and distributed through an internal power distribution unit. All RF equipment input and outputs are on rear-panel of devices.

Installation, Site Acceptance Testing (SAT) and Training

One week of installation, SAT and Training will be provided by AR Systems Engineers.

Export Classification 3A001

SSISOC100V80M18G

100 V/m field strength for vehicle component testing from 80 MHz – 18 GHz

System Frequency Range 80 MHz – 18 GHz

CW Field Strength 100 V/m (100 v/m w/ 80% AM peak conservation per ISO 11452-1)

Test Distance 1 meter

Amplifier Configuration

Models: 2500A25B, 2500 W, 10 kHz - 225 MHz;
500W1000c, 500 W, 80 - 1000 MHz;
125S1G6C, 125 W, 1 - 6 GHz;
40S6G18C 40 W, 6 - 18 GHz

Antenna Configuration

Models: ATR80M6G, Log-Periodic, 80 MHz - 6 GHz;
ATH800M6G, Horn, 1 - 6 GHz;
ATH6G18A, Horn, 6 - 18 GHz

RF Cable Configuration

Two sets (one for each amp/antenna) consisting of 2 and 5 meter lengths and designated bulkhead feedthroughs for each set.

Software Configuration

System and testing will be controlled using emcware® software which is preloaded and delivered on a new laptop as part of overall system. Price includes a 1 year support contract.

Design approach

Self-contained equipment rack with internal pre-wired RF and power with automatic RF switching via SCP2000. AC power is filtered and distributed through an internal power distribution unit. All RF equipment input and outputs are on rear-panel of devices.

Installation, Site Acceptance Testing (SAT) and Training

One week of installation, SAT and Training will be provided by AR Systems Engineers.

Export Classification 3A001

SSISOC200V10K18G

200 V/m field strength for vehicle component testing from 10 kHz – 18 GHz

System Frequency Range 10 kHz – 18 GHz

CW Field Strength 200 V/m (200 V/m w/ 80% AM peak conservation per ISO 11452-1)

Test Distance 1 meter

Amplifier Configuration

Models: 100A400A, 100 W, 10 kHz - 400 MHz;
2500A225B, 2500 W, 10 kHz - 225 MHz;
500W1000C, 500 W, 80 - 1000 MHz;
125S1G6C, 125 W, 1 - 6 GHz;
75S6G1C, 75 W, 6 - 18 GHz

Antenna Configuration

Models: Schwarzbeck TEMZ 5232 or equivalent,
Stripline, DC - 1000 MHz;
TDK HPBA-2510, Antenna, 25 - 100 MHz;
ATR80M6G, Log-Periodic, 80 MHz - 6 GHz;
ATH800M6G, Horn, 1 - 6 GHz;
ATH6G18A, Horn, 6 - 18 GHz

RF Cable Configuration

Two sets (one for each amp/antenna) consisting of 2 and 5 meter lengths and designated bulkhead feedthroughs for each set.

Software Configuration

System and testing will be controlled using emcware® software which is preloaded and delivered on a new laptop as part of overall system. Price includes a 1 year support contract.

Design approach

Self-contained equipment rack with internal pre-wired RF and power with automatic RF switching via SCP2000. AC power is filtered and distributed through an internal power distribution unit. All RF equipment input and outputs are on rear-panel of devices.

Installation, Site Acceptance Testing (SAT) and Training

One week of installation, SAT and Training will be provided by AR Systems Engineers.

Export Classification 3A001

SSISOC200V80M18G

200 V/m field strength for vehicle component testing from 80 MHz – 18 GHz

System Frequency Range	80 MHz – 18 GHz
CW Field Strength	200 V/m (200 V/m w/ 80% AM peak conservation per ISO 11452-1)
Test Distance	1 meter
Amplifier Configuration	Models: 2500A225B, 2500 W, 10 kHz - 225 MHz; 500W1000C, 500 W, 80 - 1000 MHz; 125S1G6C, 125 W, 1 - 6 GHz; 75S6G18C, 75 W, 6 - 18 GHz
Antenna Configuration	Models: ATR80M6G, Log-Periodic, 80 MHz - 6 GHz; ATH800M6G, Horn, 1 - 6 GHz; ATH6G18A, Horn, 6 - 18 GHz
RF Cable Configuration	Four sets (one for each amp/antenna) consisting of 2 and 5 meter lengths and designated bulkhead feedthroughs for each set.
Software Configuration	System and testing will be controlled using emcware® software which is preloaded and delivered on a new laptop as part of overall system. Price includes a 1 year support contract.
Design approach	Self-contained equipment rack with internal pre-wired RF and power with automatic RF switching via SCP2000. AC power is filtered and distributed through an internal power distribution unit. All RF equipment input and outputs are on rear-panel of devices.
Installation, Site Acceptance Testing (SAT) and Training	One week of installation, SAT and Training will be provided by AR Systems Engineer.
Export Classification	3A001

SSMIL10V10K18G

10 V/m field strength for military testing applications from 10 kHz – 18 GHz

System Frequency Range	10 kHz – 18 GHz
CW Field Strength	10 V/m
Test Distance	1 meter
Amplifier Configuration	Models: 50U1000, 50 W, 10 kHz - 1000 MHz; 30S1G6C, 30 W, 1 - 6 GHz; 20S6G18C, 20 W, 6 - 18 GHz
Antenna Configuration	Models: ATP10K100M, E-Field Generator, 10 kHz - 100 MHz; ATR80M6G, Log-Periodic, 80 MHz - 6 GHz; DRH-118, Horn, 1 - 18 GHz
RF Cable Configuration	Three sets (one for each amp/antenna) consisting of 2 and 5 meter lengths and designated bulkhead feedthroughs for each set.
Software Configuration	System and testing will be controlled using emcware® software which is preloaded and delivered on a new laptop as part of overall system. Price includes a 1 year support contract.
Design approach	Self-contained equipment rack with internal pre-wired RF and power with automatic RF switching via SCP2000. AC power is filtered and distributed through an internal power distribution unit. All RF equipment input and outputs are on rear-panel of devices.
Installation, Site Acceptance Testing (SAT) and Training	One week of installation, SAT and Training will be provided by AR Systems Engineers.
Export Classification	3A001

SSMIL10V2M18G

10 V/m field strength for military testing applications from 2 MHz – 18 GHz

System Frequency Range	2 MHz – 18 GHz
CW Field Strength	10 V/m
Test Distance	1 meter
Amplifier Configuration	Models: 50U1000, 50 W, 10 kHz - 1000 MHz; 30S1G6C, 30 W, 1 - 6 GHz; 20S6G18C, 20 W, 6 - 18 GHz
Antenna Configuration	Models: ATP10K100M, E-Field Generator, 10 kHz - 100 MHz; ATR80M6G, Log-Periodic, 80 MHz - 6 GHz; DRH-118, Horn, 1 - 18 GHz
RF Cable Configuration	Three sets (one for each amp/antenna) consisting of 2 and 5 meter lengths and designated bulkhead feedthroughs for each set.
Software Configuration	System and testing will be controlled using emcware® software which is preloaded and delivered on a new laptop as part of overall system. Price includes a 1 year support contract.
Design approach	Self-contained equipment rack with internal pre-wired RF and power with automatic RF switching via SCP2000. AC power is filtered and distributed through an internal power distribution unit. All RF equipment input and outputs are on rear-panel of devices.
Installation, Site Acceptance Testing (SAT) and Training	One week of installation, SAT and Training will be provided by AR Systems Engineers.
Export Classification	3A001

SSMIL50V10K18G

50 V/m field strength for military testing applications from 10 kHz – 18 GHz

System Frequency Range	10 kHz – 18 GHz
CW Field Strength	50 V/m
Test Distance	1 meter
Amplifier Configuration	Models: 1200A225B, 1200 W, 10 kHz - 225 MHz; 150W1000B, 150 W, 80 - 1000 MHz; 75S1G6C, 75 W, 1 - 6 GHz; 75S6G18C, 75 W, 6 - 18 GHz
Antenna Configuration	Models: ATP10K100MM2, E-Field Generator, 10 kHz - 100 MHz; ATR80M6G, Log-Periodic, 80 MHz - 6 GHz; DRH-118, Horn 1 - 18 GHz
RF Cable Configuration	Three sets (one for each amp/antenna) consisting of 2 and 5 meter lengths and designated bulkhead feedthroughs for each set.
Software Configuration	System and testing will be controlled using emcware® software which is preloaded and delivered on a new laptop as part of overall system. Price includes a 1 year support contract.
Design approach	Self-contained equipment rack with internal pre-wired RF and power with automatic RF switching via SCP2000M3. AC power is filtered and distributed through an internal power distribution unit. All RF equipment input and outputs are on rear-panel of devices.
Installation, Site Acceptance Testing (SAT) and Training	One week of installation, SAT and Training will be provided by AR Systems Engineers.
Export Classification	3A001

SSMIL50V2M18G

50 V/m field strength for military testing applications from 2 MHz – 18 GHz

System Frequency Range 2 MHz – 18 GHz

CW Field Strength 50 V/m

Test Distance 1 meter

Amplifier Configuration

Models: 1200A225B, 1200 W, 10 kHz - 225 MHz;
150W1000B, 150 W, 80 - 1000 MHz;
75S1G6C, 75 W, 1 - 6 GHz;
75S6G18C, 75 W, 6 - 18 GHz

Antenna Configuration

Models: ATP10K100MM2, E-Field Generator, 10 kHz - 100 MHz;
ATR80M6C, Log-Periodic, 80 MHz - 6 GHz;
DRH-118, Horn, 1 - 18 GHz

RF Cable Configuration

Three sets (one for each amp/antenna) consisting of 2 and 5 meter lengths and designated bulkhead feedthroughs for each set.

Software Configuration

System and testing will be controlled using emcware® software which is preloaded and delivered on a new laptop as part of overall system. Price includes a 1 year support contract.

Design approach

Self-contained equipment rack with internal pre-wired RF and power with automatic RF switching via SCP2000M3. AC power is filtered and distributed through an internal power distribution unit. All RF equipment input and outputs are on rear-panel of devices.

Installation, Site Acceptance Testing (SAT) and Training

One week of installation, SAT and Training will be provided by AR Systems Engineers.

Export Classification 3A001

SSMIL200V10K18G

200 V/m field strength for military testing applications from 10 kHz – 18 GHz

System Frequency Range 10 kHz – 18 GHz

CW Field Strength 200 V/m

Test Distance 1 meter

Amplifier Configuration

Models: 2500A225B, 2500 W, 10 kHz - 225 MHz;
200W1000C, 500 W, 80 - 1000 MHz;
125S1G6C, 125 W, 1 - 6 GHz;
75S6G18C, 75 W, 6 - 18 GHz

Antenna Configuration

Models: ATE10K30MAM2, E-Field Generator, 10 kHz - 30 MHz;
TDK HPBA-2510, Antenna, 25 - 100 MHz;
ATR80M6GM2, Log-Periodic, 80 MHz - 6 GHz;
ATH200M2G, Horn, 200 MHz - 2 GHz;
ATH800M6G, Horn, 1 - 6 GHz;
ATH6G18A, Horn, 6 - 18 GHz

RF Cable Configuration

Four sets (one for each amp/antenna) consisting of 2 and 5 meter lengths and designated bulkhead feedthroughs for each set.

Software Configuration

System and testing will be controlled using emcware® software which is preloaded and delivered on a new laptop as part of overall system. Price includes a 1 year support contract.

Design approach

Self-contained equipment rack with internal pre-wired RF and power with automatic RF switching via SCP2000M3. AC power is filtered and distributed through an internal power distribution unit. All RF equipment input and outputs are on rear-panel of devices.

Installation, Site Acceptance Testing (SAT) and Training

One week of installation, SAT and Training will be provided by AR Systems Engineers.

Export Classification 3A001

SSMIL200V2M18G

200 V/m field strength for military testing applications from 2 MHz – 18 GHz

System Frequency Range 2 MHz – 18 GHz

CW Field Strength 200 V/m

Test Distance 1 meter

Amplifier Configuration

Models: 2500A225B, 2500 W, 10 kHz - 225 MHz;
500W1000C, 500 W, 80 - 1000 MHz;
125S1G6C, 125 W, 1 - 6 GHz;
75S6G18C, 75 W, 6 - 18 GHz

Antenna Configuration

Models: ATE10K30MAM2, E-Field Generator, 10 kHz - 30 MHz;
TDK HPBA-2510, Antenna, 25 - 100 MHz;
ATR80M6GM2, Log-Periodic, 80 MHz - 6 GHz;
ATH500M2G, Horn, 200 Mhz - 2 GHz;
ATH800M6G, Horn, 1 - 6 GHz;
ATH6G18A, Horn, 6 - 18 GHz

RF Cable Configuration

Four sets (one for each amp) consisting of 2 and 5 meter lengths and designated bulkhead feedthroughs for each set.

Software Configuration

System and testing will be controlled using emcware® software which is preloaded and delivered on a new laptop as part of overall system. Price includes a 1 year support contract.

Design approach

Self-contained equipment rack with internal pre-wired RF and power with automatic RF switching via SCP2000M3. AC power is filtered and distributed through an internal power distribution unit. All RF equipment input and outputs are on rear-panel of devices.

Installation, Site Acceptance Testing (SAT) and Training

One week of installation, SAT and Training will be provided by AR Systems Engineers.

Export Classification 3A001

SSMIL200V18G40

200 V/m field strength for from 18 – 40 GHz

System Frequency Range 18 – 40 GHz

CW Field Strength 200 V/m

Test Distance 1 meter

Amplifier Configuration

Models: 40T18G26A, 40 W, 18 - 26.5 GHz;
40T26G40A, 40 W, 26.5 - 40 GHz

Antenna Configuration

Models: ATH18G27A, High Gain Horn, 18 - 26.5 GHz;
ATH26G40A, High Gain Horn, 26.5 - 40 GHz

RF Cable Configuration

Internal waveguide with antennas mounted to shielded rack to minimize losses.

Software Configuration

System and testing will be controlled using emcware® software which is preloaded and delivered on a new laptop as part of overall system. Price includes a 1 year support contract.

Design approach

Self-contained equipment rack with internal pre-wired RF and power with automatic RF switching via SCP2000. AC power is filtered and distributed through an internal power distribution unit. All RF equipment input and outputs are on rear-panel of devices.

Installation, Site Acceptance Testing (SAT) and Training

One week of installation, SAT and Training will be provided by AR Systems Engineers.

Export Classification 3A001

CI00402

10 kHz – 400 MHz
100 W



Complete Testing Solutions to the following standards:

MIL-STD-461 CS114, DO160 (Section 20) BCI Testing, EN/IEC 61000-4-6, IEC 60601-1-2, EN 50130-4, EN 61000-6-1/2, EN 55024, ISO 11452-4

Internal Test Specifications*

MIL-STD-461 (CS114), DO160 (Sec 20 BCI Test), IEC/EN 60601-1-2, IEC/EN 50130-4, IEC/EN 61326, IEC/EN 61000-6-1, IEC/EN 61000-6-2, IEC/EN 61000-4-6, CISPR 24/EN 55024, ISO 11452-4, EMC-CS-2009, GM GMW3097, BMW GS95002, Chrysler DC-11224, Renault 36-00-808

Signal Generator Specifications

Frequency Range/Resolution 9 kHz – 1.5 GHz / 0.01 Hz
Power Range/Resolution –110 to +13 dBm / 0.01 dB
Modulation AM, FM, Phase, Int Pulse, Ext Pulse

Spectrum Analyzer Specifications

Frequency Range/Resolution 9 kHz – 1.5 GHz / 1 Hz
RF Power CW (max) Atten = 30 dB 20 dBm
Resolution BW 10 Hz – 1 MHz
Video BW 1 Hz – 3 MHz
Amplitude Measurement Range
–110 dBm to +20 dBm in 1 dB steps
Preamplifier Gain 20 dB (nom)
Sweep Time, span > 100 Hz 10 msec – 1,500 sec

RF Solid State Amplifier Specifications

Frequency Range 10 kHz – 400 MHz
Power Rating 100 W min.
At 1 dB compression the power is 75 W min.
Harmonic Distortion –20 dBc at 75 W

Mismatch Tolerance

100% of rated power without fold back. Will operate without damage or oscillation with any magnitude of source and load impedance.

Gain 50 dB min.

Connections

RF Out Type N (front)
Monitor Port In Type N (front)
Signal Generator Out Type N (rear)
RF Amp In/Out Type N (rear)
Directional Coupler In Type N (rear)
Pulse In BNC (rear)
Communication USB B (rear)
Directional Coupler Fwd Out Type SMA (rear)
Directional Coupler Fwd In Type SMA (rear)
Directional Coupler Rev Out Type SMA (rear)
Directional Coupler Rev In Type SMA (rear)

General

Power 115/230 VAC, 50/60 Hz, single phase 16 A
Breaker 2 pole, 20 A
Cooling Active cooling, air ventilation
Environmental Conditions 10°C – 40°C (50°F – 104°F)
Dimensions 50.3 x 53.3 x 55.1 cm (19.8 x 21 x 21.7 in.)
Weight 49.9 kg (110 lb.)

PC Requirements

Computer Intel i5 or equivalent
Operating System Windows 7 SP1, 8.1, or 10
RAM 4 GB Minimum
Screen Resolution 1024 x 768
Ports 2 available USB 2 ports
Software Requirements Microsoft Word/Excel 2010 or newer

CI00403

10 kHz – 400 MHz
175 W



Complete Testing Solutions to the following standards:

MIL-STD-461 CS114, DO160 (Section 20) BCI Testing, EN/IEC 61000-4-6, IEC 60601-1-2, EN 50130-4, EN 61000-6-1/2, EN 55024, ISO 11452-4

Internal Test Specifications*

MIL-STD-461 (CS114), DO160 (Sec 20 BCI Test), IEC/EN 60601-1-2, IEC/EN 50130-4, IEC/EN 61326, IEC/EN 61000-6-1, IEC/EN 61000-6-2, IEC/EN 61000-4-6, CISPR 24/EN 55024, ISO 11452-4, EMC-CS-2009, GM GMW3097, BMW GS95002, Chrysler DC-11224, Renault 36-00-808

Signal Generator Specifications

Frequency Range/Resolution 9 kHz – 1.5 GHz / 0.01 Hz
Power Range/Resolution –110 to +13 dBm / 0.01 dB
Modulation AM, FM, Phase, Int Pulse, Ext Pulse

Spectrum Analyzer Specifications

Frequency Range/Resolution 9 kHz – 1.5 GHz / 1 Hz
RF Power CW (max) Atten = 30 dB 20 dBm
Resolution BW 10 Hz – 1 MHz
Video BW 1 Hz – 3 MHz
Amplitude Measurement Range
–110 dBm to +20 dBm in 1 dB steps
Preamplifier Gain 20 dB (nom)
Sweep Time, span > 100 Hz 10 msec – 1,500 sec

RF Solid State Amplifier Specifications

Frequency Range 10 kHz – 400 MHz
Power Rating 175 W min.
At 1 dB compression the power is 125 W min.
Harmonic Distortion –20 dBc at 150 W

Mismatch Tolerance

100% of rated power without fold back. Will operate without damage or oscillation with any magnitude of source and load impedance.

Gain 52.5 dB min

Connections

RF Out Type N (front)
Monitor Port In Type N (front)
Signal Generator Out Type N (rear)
RF Amp In/Out Type N (rear)
Directional Coupler In Type N (rear)
Pulse In BNC (rear)
Communication USB B (rear)
Directional Coupler Fwd Out Type SMA (rear)
Directional Coupler Fwd In Type SMA (rear)
Directional Coupler Rev Out Type SMA (rear)
Directional Coupler Rev In Type SMA (rear)

General

Power 115/230 VAC, 50/60 Hz, single phase 16 A
Breaker 2 pole, 20 A
Cooling Active cooling, air ventilation
Environmental Conditions 10°C – 40°C (50°F – 104°F)
Dimensions 128.9 x 56.1 x 91.4 cm / 52.5 x 22.1 x 36 in
Weight 72.6 kg (160 lb)

PC Requirements

Computer Intel i5 or equivalent
Operating System Windows 7 SP1, 8.1, or 10
RAM 4 GB Minimum
Screen Resolution 1024 x 768
Ports 2 available USB 2 ports
Software Requirements Microsoft Word/Excel 2010 or newer

CI01000 100 kHz – 1000 MHz 250 W



Complete Testing Solutions to the following standards:

EN/IEC 61000-4-6, IEC 60601-1-2, EN 50130-4, EN 61000-6-1/2, ISO 11452-4

Internal Test Specifications*

IEC/EN 60601-1-2, IEC/EN 50130-4, IEC/EN 61326, IEC/EN 61000-6-1, IEC/EN 61000-6-2, IEC/EN 61000-4-6, ISO 11452-4, MIL-STD-461 CS114

Signal Generator Specifications

Frequency Range/Resolution	9 kHz – 1.5 GHz / 0.01 Hz
Power Range/Resolution	-110 to +13 dBm / 0.01 dB
Modulation	AM, FM, Phase, Int Pulse, Ext Pulse

Spectrum Analyzer Specifications

Frequency Range/Resolution	9 kHz – 1.5 GHz 1 Hz
RF Power CW (max) Atten = 30 dB	20 dBm
Resolution BW	10 Hz – 1 MHz
Video BW	1 Hz – 3 MHz
Amplitude Measurement Range	-110 dBm to +20 dBm in 1 dB steps
Preamplifier Gain	20 dB (nom)
Sweep Time, span> 100 Hz	10 msec – 1500 sec

RF Solid State Amplifier Specifications

Frequency Range	100 kHz – 1000 MHz
Power Rating	250 Watts
Minimum At 1 dB compression	175 Watts Minimum
Harmonic Distortion	0 dBc at 75 Watts

Mismatch Tolerance

100% of rated power without fold back. Will operate without damage or oscillation with any magnitude of source and load impedance.

Gain 54 dB min.

Connections

RF Out	Type N (front)
Monitor Port In	Type N (front)
Signal Generator Out	Type N (rear)
RF Amp In/Out	Type N (rear)
Directional Coupler In	Type N (rear)
Pulse In	BNC (rear)
Communication	USB B (rear)
Directional Coupler Fwd Out	Type SMA (rear)
Directional Coupler Fwd In	Type SMA (rear)
Directional Coupler Rev Out	Type SMA (rear)
Directional Coupler Rev In	Type SMA (rear)

General

Power	115/230 VAC, 50/60 Hz, single phase 16 A
Breaker	2 pole, 20 A
Cooling	Active cooling, air ventilation
Environmental Conditions	10°C – 40°C (50°F – 104°F)
Dimensions	50.3 x 53.3 x 55.1 cm (19.8 x 21 x 21.7 in.)
Weight	49.9 kg (110 lb.)

PC Requirements

Computer	Intel i5 or equivalent
Operating System	Windows 7 SP1, 8.1, or 10
RAM	4 GB Minimum
Screen Resolution	1024 x 768
Ports	2 available USB 2 ports
Software Requirements	Microsoft Word/Excel 2010 or newer

MT2IEC10V3M Multi-Tone RF Radiated Immunity System



The MT2IEC10V3M Multi-Tone system is designed to develop a 1.5 x 1.5 meter uniform field area (UFA) with an 18 V/m CW field strength at up to a 3 meter test distance in accordance with IEC 61000-4-3. This system has an operating frequency range from 80 MHz – 6 GHz. Two internal signal generators allow two simultaneous test frequencies allowing for an up to 50% reduction in sweep time.

The signal generation, control, and power monitoring equipment shall be mounted in a ventilated equipment rack along with the RF amplifiers.

The MT2IEC10V3M AR System consists of the AR equipment, listed herein. Please refer to individual product specification sheets for details.

The export classification for this equipment is 3A001. This equipment is controlled for export in accordance with the U.S. Export Administration Regulations. Diversion contrary to U.S. law is prohibited.

AR Standardized Systems are customizable upon request. Contact AR for all such requests.

Complete Testing Solutions to the following standards:

Radiated Immunity

- EN/IEC 61000-4-3
- ISO11452-2 Auto (ALSE)
- ISO11452-3 Auto (TEM cells)
- ISO11451-5 Auto (Strip Line)
- ISO11451 – 2 Full Vehicle
- DO-160 Section 20.5 (Substitution Method)
- EN/IEC 60601-1, -2
- EN 50130-4
- EN 61000-6-1/2
- EN 55024

System Frequency Range 80 MHz - 6 GHz

Number of Tones Up to two

Field Strength 18 V/m CW
(10 V/m w/ 80% AM)

Test Distance Up to 3 meters

UFA 1.5 x 1.5 meters

Amplifier Configuration

Models: 250W1000C, 250 W, 80 - 1000 MHz;
75S1G6C, 75 W, 1 - 6 GHz

Antenna Configuration

Models: ATR80M6G, Log-Periodic, 80 MHz - 6 GHz;
ATT700M12G, Log-Periodic, 700 MHz - 12 GHz

RF Cable Configuration

Two sets (one for each amp/antenna) consisting of 2 and 5 meter lengths and designated bulkhead feedthroughs for each set.

Software Configuration

System and testing will be controlled using emcware® software which is preloaded and delivered on a new PC as part of overall system.

Design Approach

Self-contained equipment rack with internal pre-wired RF and power with automatic RF switching via SCP2000. AC power is filtered and distributed through an internal power distribution unit. All RF equipment input and outputs are on rear-panel of devices.

Export Classification 3A001

MT4IEC10V3M Multi-Tone RF Radiated Immunity System



The MT4IEC10V3 Multi-Tone system is designed to develop a 1.5 x 1.5 meter uniform field area (UFA) with an 18 V/m CW field strength at up to a 3 meter test distance in accordance with IEC 61000-4-3. This system has an operating frequency range from 80 MHz – 6 GHz. Four internal signal generators allow you to four simultaneous test frequencies allowing for an up to 74% reduction in sweep time. The signal generation, control, and power monitoring equipment shall be mounted in a ventilated equipment rack along with the RF amplifiers. The MT4IEC10V3 AR System consists of the AR equipment, listed herein. Please refer to individual product specification sheets for details.

Complete Testing Solutions to the following standards:

Radiated Immunity

- EN/IEC 61000-4-3
- ISO11452-2 Auto (ALSE)
- ISO11452-3 Auto (TEM cells)
- ISO11451-5 Auto (Strip Line)
- ISO11451 – 2 Full Vehicle
- DO-160 Section 20.5 (Substitution Method)
- EN/IEC 60601-1, -2
- EN 50130-4
- EN 61000-6-1/2
- EN 55024

System Frequency Range	80 MHz - 6 GHz
Number of Tones	Up to four
Field Strength	18 V/m CW (10 V/m w/ 80% AM)
Test Distance	Up to 3 meters
UFA	1.5 x 1.5 meters
Amplifier Configuration	Models: 500W1000C, 500 W, 80 - 1000 MHz; 125S1G6C, 125 W, 1 - 6 GHz
Antenna Configuration	Models: ATR80M6G, Log-Periodic, 80 MHz - 6 GHz; ATT700M12G, Log-Periodic, 700 MHz - 12 GHz
RF Cable Configuration	Two sets (one for each amp/antenna) consisting of 2 and 5 meter lengths and designated bulkhead feedthroughs for each set.
Software Configuration	System and testing will be controlled using emware® software which is preloaded and delivered on a new PC as part of overall system.
Design Approach	Self-contained equipment rack with internal pre-wired RF and power with automatic RF switching via SCP2000. AC power is filtered and distributed through an internal power distribution unit. All RF equipment input and outputs are on rear-panel of devices.
Export Classification	3A001



Antennas

AR offers a wide range of high power, log periodic, high-gain horn, and bent element antennas, and more. With antennas available up to 50 GHz and 20,000 W of input CW power, our innovative antennas offer features available exclusively from AR.

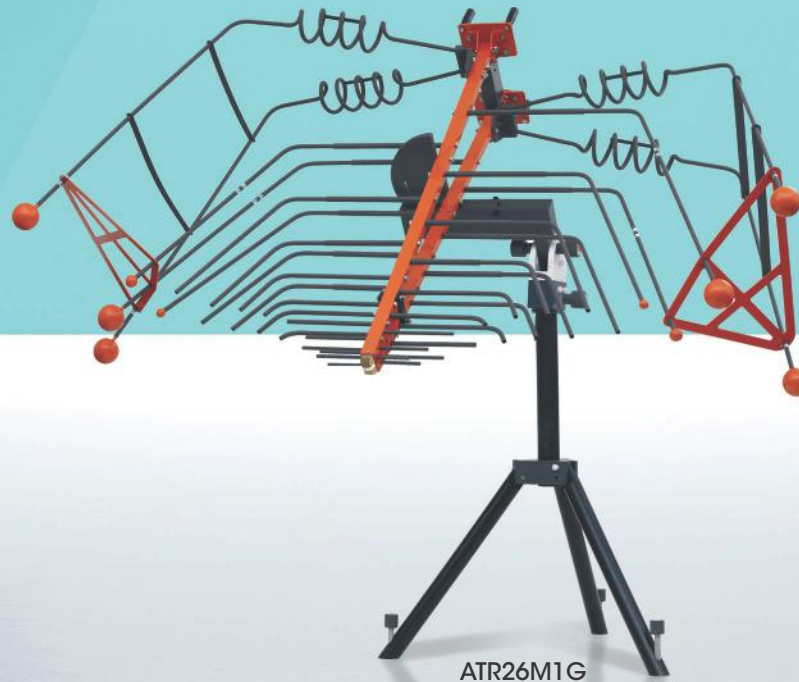

ATR26M1G



ATR26M250 26 – 250 MHz 15000 W



Frequency range	26 – 250 MHz
Power input (max.)	15000 W
Gain (over isotropic)	-3 to +6 dBi (26 – 80 MHz) 6 dBi (80 – 250 MHz)
Gain flatness	±1.5 dBi (80 – 250 MHz)
Impedance	50 ohms nominal
VSWR (max.)	3.5:1 (80 – 250 MHz) 10:1 (26 – 80 MHz)
Beamwidth (average)	Typical curves available on request
Connector	1 5/8 EIA quick change connector
Size (w x h x d)	279.4 x 53.6 x 202.4 cm (110 x 21.1 x 79.7 in.)
Weight (max.)	31.8 kg (70 lb.)

Mounting
May be mounted in two perpendicular planes using an optional antenna positioner (AP5010B). One non-metallic mast (4 foot) is included for vertical mounting.

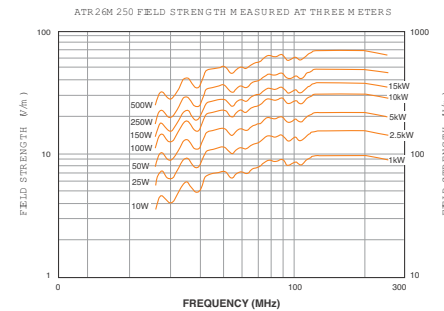
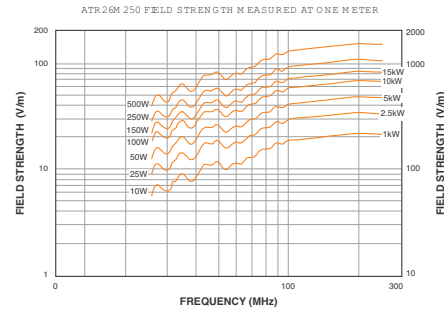

ATR26M1G 26 MHz – 1 GHz 20000 W



Frequency range	26 MHz–1 GHz
Power input, CW	20 kW @ 26 MHz, derate to 5 kW @ 1000 MHz
Gain (over isotropic)	-8 to 0 dB (26–80 MHz) 0–6 dB (80–1000 MHz)
Gain flatness	±3 dB (80–1000 MHz)
Impedance	50 ohms nominal
VSWR (max.)	6:1 (26–80 MHz) 3.5:1 (80–1000 MHz)
Beamwidth (average)	Typical curves available on request
Connector	1 5/8 EIA male with removable center bullet
Size (W X H X D)	231 x 66 x 183 cm (91 x 26 x 72 in.)
Weight (max.)	29.5 kg (65 lb.)

Mounting
May be mounted in two perpendicular planes using an optional antenna positioner (AP5010B). One non-metallic mast (4 foot) is included for vertical mounting.

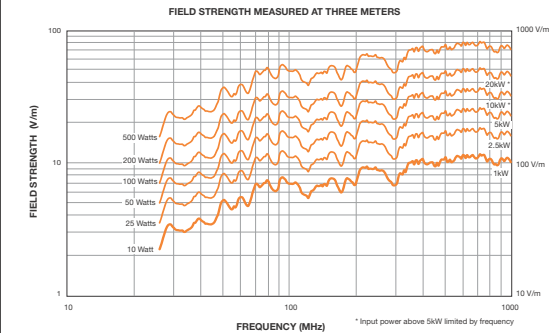
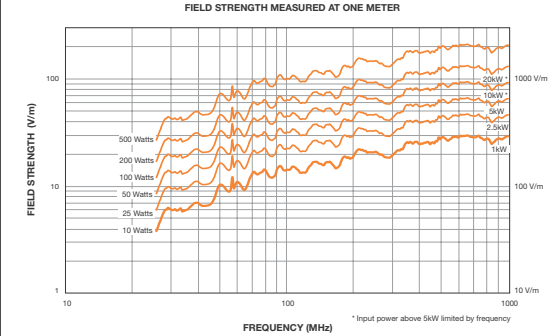

ATR26M6G 26 MHz – 6 GHz 5000 W



ATR26M 6G FIELD STRENGTH MEASURED AT ONE METER

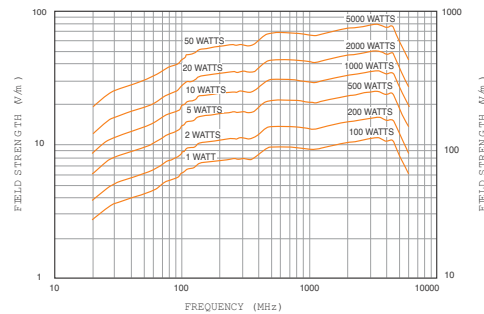

ATR26M 6G FIELD STRENGTH MEASURED AT THREE METERS

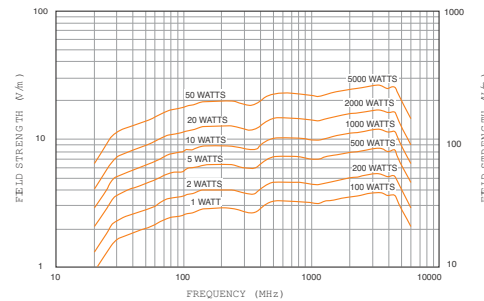

Frequency range	26 MHz – 6 GHz
Power input (max.)	5000 W
Gain (over isotropic)	-3 to +6 dBi (26 – 80 MHz) 6 dBi (80 MHz – 6 GHz)
Gain flatness	±1.5 dB (80 – 6 GHz)
Impedance	50 ohms nominal
VSWR (max.)	3:1 (80 – 6 GHz) 10:1 (26 – 80 MHz)
Beamwidth (average)	Typical curves available on request
Connector	Type N (F) quick change connector
Size (w x h x d)	279.4 x 53.6 x 202.4 cm (110 x 21.1 x 79.7 in.)
Weight (max.)	22.7 kg (50 lb.)

Mounting
May be mounted in two perpendicular planes using an optional antenna positioner (AP5010B). One non-metallic mast (4 foot) is included for vertical mounting.

ATR26M6G-1 26 MHz – 6 GHz 5000 W



FIELD STRENGTH MEASURED AT ONE METER

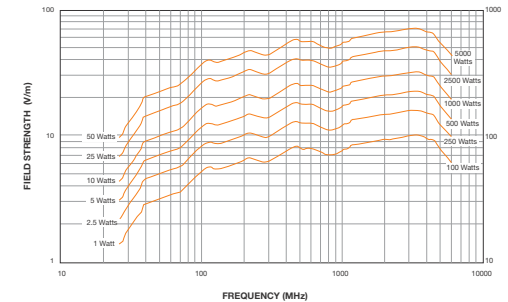

FIELD STRENGTH MEASURED AT THREE METERS

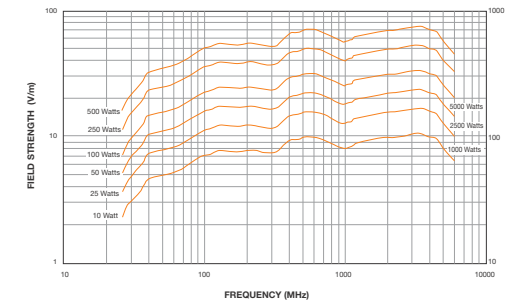

Frequency range	26 MHz – 6 GHz
Power input (max.)	5000 W
Gain (over isotropic)	-4 to 6 dB (26 – 80 MHz) 6 dB (80 MHz – 6 GHz)
Gain flatness	±1.5 dB (80 MHz – 6 GHz)
Impedance	50 ohms nominal
VSWR (max.)	6:1 (26 – 80 MHz) 3:1 (80 MHz – 6 GHz)
Beamwidth (average)	Typical curves available on request
Connector	Type N (F) quick change connector; Type C (F) supplied for higher power applications
Size (w x h x d)	218.4 x 73.7 x 161.3 cm (86 x 29 x 63.5 in.)
Weight (max.)	13.6 kg (30 lb.)

Mounting
May also be mounted using the optional AP5010B antenna positioner or the TP1000BM3 tripod with ballast tray. Also includes 2 non-metallic masts (4 and 6 feet) vertical mounting.

ATL80M1G 80 MHz – 1 GHz 2000 W

Frequency range	80 MHz – 1 GHz
Power input (max.)	2000 W
Gain (over isotropic) 7.5 dBi avg.	6.5 dBi min., 7.5 dBi avg.
Gain flatness	±1 dBi
Impedance	50 ohms nominal
VSWR (max.) 1.5:1 (average)	1.8:1 (max.)
Beamwidth (average)	E plane 60° H plane 105°
Front to back ratio (min.)	15 dB
Connector	Type N (F) quick change connector Type C (F) supplied for higher power applications
Size (w x h x d) (76 x 5.1 x 63 in.)	193 x 13 x 160 cm
Weight (max.)	7.7 kg (17 lb)
Mounting	May be mounted using the optional TP1000B tripod.

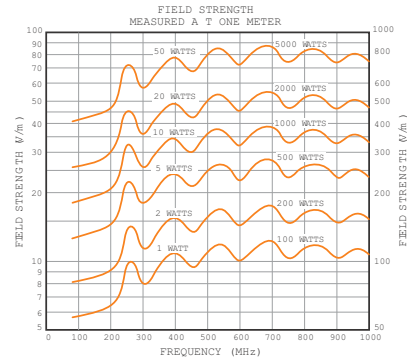

Note: Curves above 1000 and 2000 watts do not apply past power/frequency limits of the antenna.

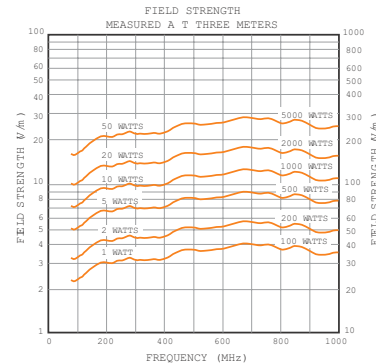

ATR80M6G 80 MHz – 6 GHz 5000 W

Frequency range	80 MHz–6 GHz
Power input (max.)	5000 W
Gain (over isotropic)	6 dBi
Gain flatness	±2 dBi
Impedance	50 ohms nominal
VSWR (max.)	3:1 2:1 (typical)
Beamwidth (average)	Typical curves available on request
Connector	Type N (F) quick change connector
Size (w x h x d)	132.1 x 20.32 x 97.8 cm (52 x 8 x 38.5 in.)
Weight (max.)	7.94 kg (17.5 lb)

Mounting
May be tripod mounted in two perpendicular planes using optional tripod. Also includes one non-metallic mast for vertical mounting.

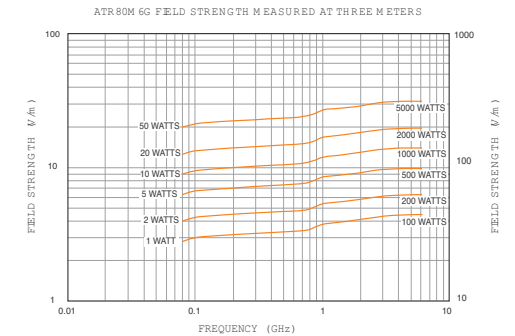
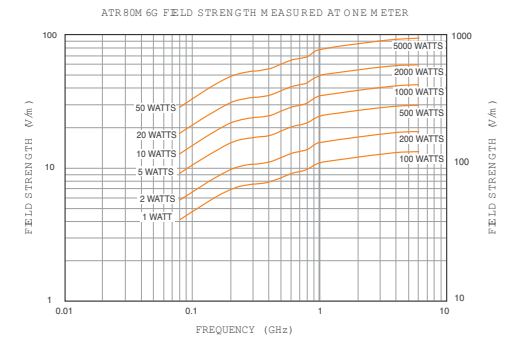

ATL150M1G 150 MHz – 1 GHz 2000 W



Frequency range	150 MHz – 1 GHz
Power input (max.)	2000 W
Gain (over isotropic)	6.5 dBi min., 7.5 dBi avg.
Gain flatness	±1 dBi
Impedance	50 ohms nominal
VSWR (max.)	1.8:1 (max.) 1.5:1 (average)
Beamwidth (average)	E plane 60° H plane 105°
Front to back ratio (min.)	15 dB
Connector	Type N (F) quick change connector Type C (F) supplied for higher power applications
Size (w x h x d)	102 x 13 x 91 cm (40 x 5.1 x 36 in.)
Weight (max.)	7 kg (15 lb.)
Mounting	May be mounted using the optional TP1000B tripod.

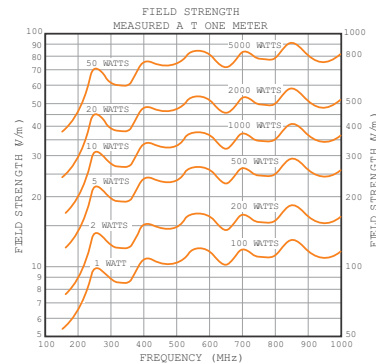

Note: Curves above 1000 and 2000 watts do not appear past power/frequency limits of the antenna.

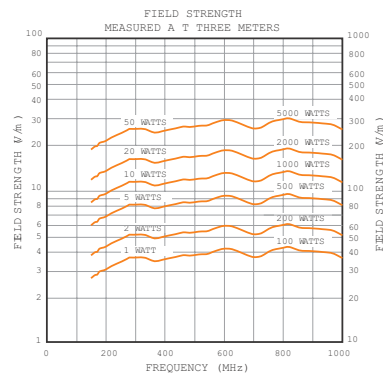

LP1, LP3 & LP6 200 MHz – 2 GHz 200 MHz – 3 GHz 200 MHz – 6 GHz

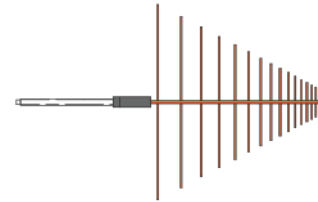

Gain	6 dBi typical
Impedance	50 ohms nominal
Connector	Type N female
VSWR	2:1 max.
Polarization	Linear
Max Power	LP1-300 W CW LP3-250 W CW LP6-200 W CW
Size (LxWxH)	48 x 3 x 29.5 in 122 x 8 x 75 cm
Weight	8 lbs. (3.6 kg)
Mounting Tube	22 mm dia. stainless steel
Finish	Orange powdercoat

ATR200M6G

200 MHz – 6 GHz
5000 W



Frequency range	200 MHz – 6 GHz
Power input (max.)	5000 W
Gain (over isotropic)	6 dBi
Gain flatness	±1.5 dBi
Impedance	50 ohms nominal
VSWR (max.)	3:1 2:1 (typical)
Beamwidth (average)	Typical curves available on request
Connector	Type N (F) quick change connector
Size (w x h x d)	82.6 x 17.8 x 57.2 cm (32.5 x 7 x 22.5 in.)
Weight (max.)	5 kg (12 lb.)

Mounting
May be tripod mounted in two perpendicular planes using optional tripod. Also includes one non-metallic mast for vertical mounting.

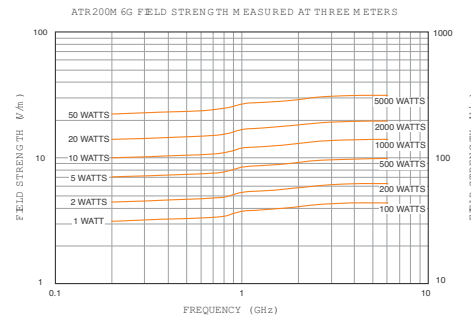
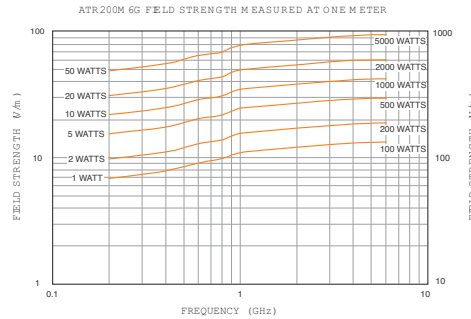

ATT700M8G

700 MHz – 7.5 GHz
1200 W



Frequency range	700 MHz–7.5 GHz
Power input (max.)	1,200 W
Gain (over isotropic)	8 dBi typ.
Gain flatness	±1.5 dBi
Impedance	50 ohms nominal
VSWR (max.)	3:1 (max.) 1.7:1 (average)
Beamwidth (average)	E plane 57° H plane 60°
Connector	7–16 DIN (F)
Size (w x h x d)	28 x 28 x 56 cm (11 x 11 x 22 in.)
Weight (max.)	1.8 kg (4 lb.)

Mounting
May be tripod mounted with included mount.

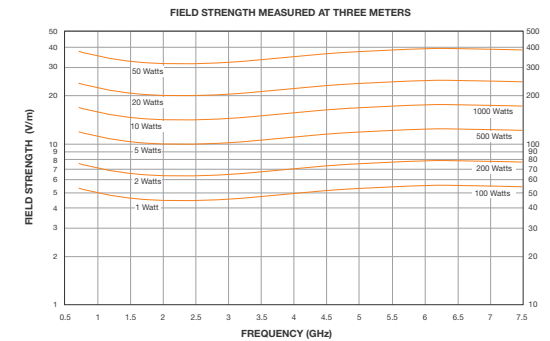
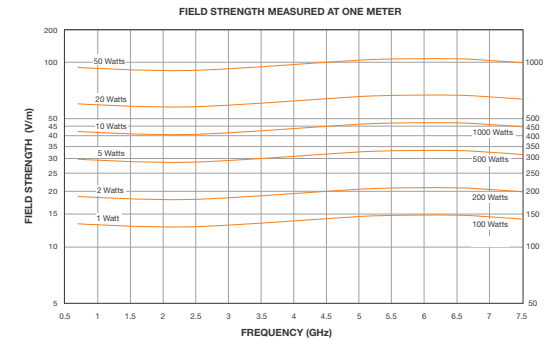

ATT700M12G 700 MHz – 12 GHz 600 W

Frequency range	700 MHz – 12 GHz
Power input (max.)	600 W max.
Far Field Gain	8 dBi typ.
Gain flatness	±1.5 dBi
Impedance	50 ohms nominal
VSWR (max.)	3:1 (max.) 1.7:1 (average)
3 dB Beamwidth (average)	E plane 57° H plane 60°
Connector	Type N (F)
Size (w x h x d)	28 x 28 x 55 cm (11 x 11 x 21.5 in.)
Weight (max.)	1.7 kg (3 lb., 12 oz)
Mounting	May be tripod mounted with included mount.

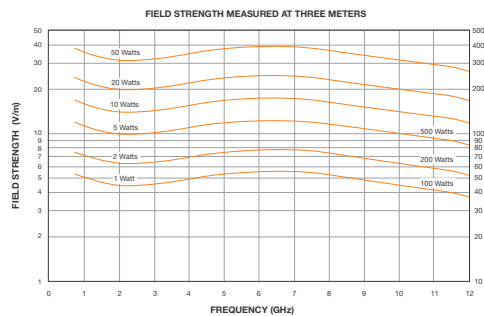
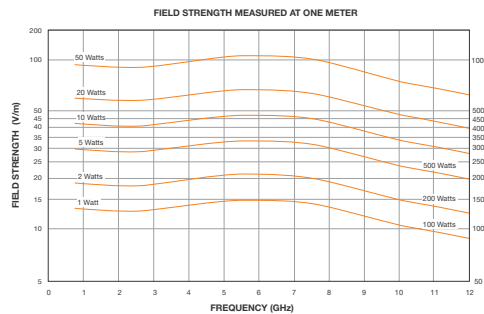

JB1, JB3 & JB6 30 MHz – 2 GHz 30 MHz – 3 GHz 30 MHz – 6 GHz

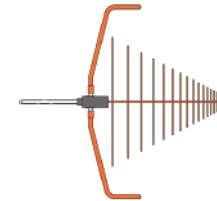

Frequency Range	JB1 30 MHz – 2 GHz JB3 30 MHz – 3 GHz JB6 30 MHz – 6 GHz
Impedance	50 ohms nominal
Connector	Type N female
VSWR	<2:1 above 200MHz
Polarization	Linear
Imbalance	Less than 1 dB
Max. Power:	See curve in spec sheet
Size (LxW)	51 x 19 in, 130 x 48 cm
Wing Span	44 in (112 cm)
Weight	10 lbs. (5 kg)
Mounting Tube	22 mm dia. stainless steel
Wing Mount	Dual compression
Finish	Orange powdercoat
Options	SunAR SNAP! Mount Tripod mount Carrying case

ATH200M1G 200 MHz – 1 GHz 5000 W



Frequency range	200 MHz – 1 GHz
Power input (max.)	5000 W
Gain (over isotropic)	10 dBi min. typically increasing to 18 dBi at 1000 MHz
Impedance	50 ohms nominal
VSWR (max.)	2.5:1 max., 1.5:1 avg.
Beamwidth (average)	Typical curves available on request
Connector	Type 1–5/8 EIA Flange, Quick Change Connector
Size (w x h x d)	109.2 x 145.8 x 175.3 cm (43 x 57 x 69 in.)
Weight (max.)	46 kg (100 lb.)

Mounting
Heavy-duty tripod included. Pads with 3/8–16 thread for stand mounting vertically or horizontally.

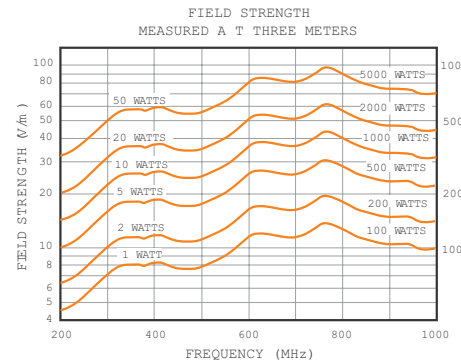
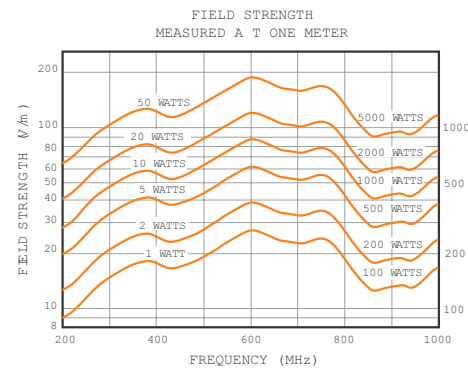

ATH200M1G-1 200 MHz – 1 GHz 10000 W



Frequency range	200 MHz–1 GHz
Power input (max.)	10000 W
Gain (over isotropic)	10 dBi min. typically increasing to 18 dBi at 1000 MHz
Impedance	50 ohms nominal
VSWR (max.)	2.5:1 max., 1.5:1 avg.
Beamwidth (average)	Typical curves available on request
Connector	Type 1–5/8 EIA Flange,
Size (w x h x d)	109.2 x 145.8 x 175.3 cm (43 x 57 x 69 in.)
Weight (max.)	46 kg (100 lb.)

Mounting
Heavy-duty tripod included. Pads with 3/8–16 thread for stand mounting vertically or horizontally.

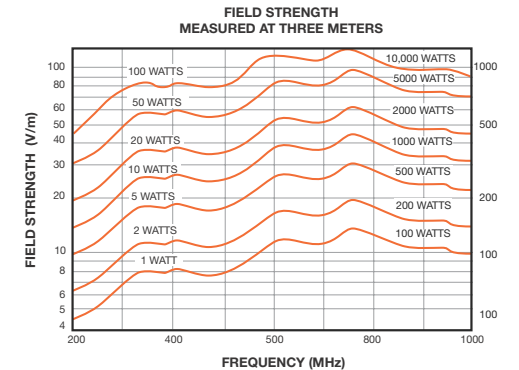
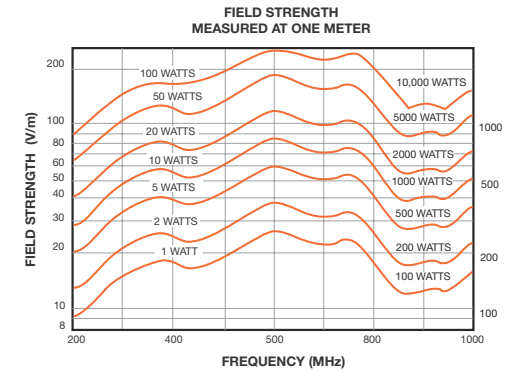

ATH200M2G 200 MHz – 2 GHz 1000 W



Frequency range	200 MHz – 2 GHz
Power input (max.)	1000 W
Gain (over isotropic)	6 dBi typ.
VSWR (typ.)	2:1
Beamwidth (avg.) E Plane H Plane	(beamwidth graph available on request)
Front To Back Ratio (min.)	20 dBi
Connector	N (f) Precision
Size (w x h x d)	72.9 x 97.8 x 93.2 cm (28.7 x 38.5 x 36.7 in.)
Weight	10.21 kg (22.5 lb.)

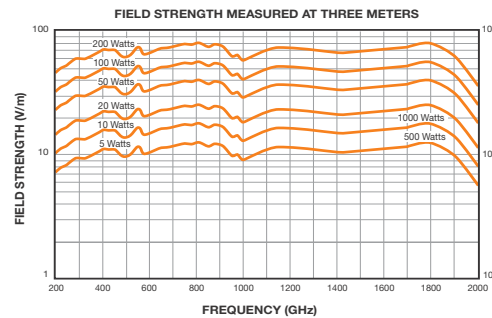
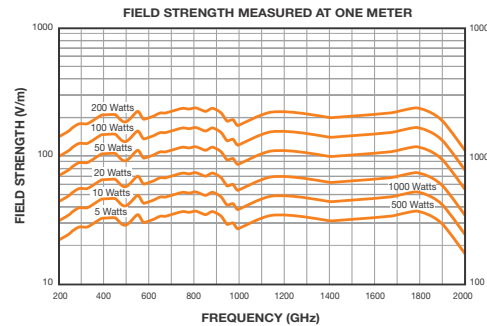

ATH400M1G 400 MHz – 1 GHz 3000 W



Frequency range	400 MHz – 1 GHz
Power input (max.)	See graphs.
Gain (over isotropic)	10 dBi min. typically increasing to 15 dBi at 1000 MHz
Impedance	50 ohms nominal
VSWR (max.)	2.5:1 max., 1.5:1 avg.
Beamwidth (average)	See curve
Connector	Quick Change block. See Model Configurations.
Size (w x h x d)	56.4 x 79.3 x 73.7 cm (22.2 x 31.2 x 29 in.)
Weight (max.)	9.1 kg (20 lb.)

Mounting
Rear flange for wall mount. Pads with 1/4–20 thread for tripod mount.

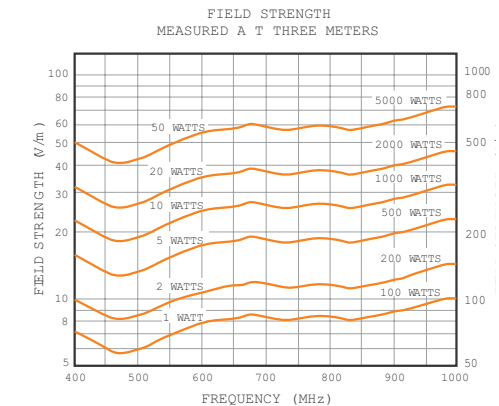
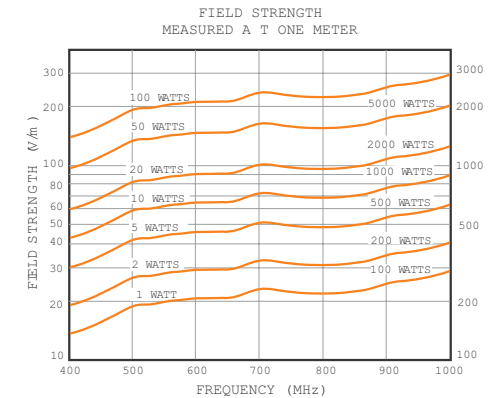

ATH800M6G

800 MHz – 6 GHz
2300 W

Frequency range	800 MHz–6 GHz
Power input (max.)	2,300 W (connector dependent)
Gain	11 dBi min, increasing to 22 dBi at 6 GHz
VSWR (max.)	
Max.	2.5:1
Average	1.6:1
Beamwidth (avg.) at 3 dBi down from peak	
E Plane	27.5°
H Plane	25°
Connector	7–16 DIN (F)
Size (w x h x d)	46.3 x 46.3 x 69.2 cm (18.25 x 18.25 x 27.25 in.)
Weight (max.)	7.26 kg (16 lb.)

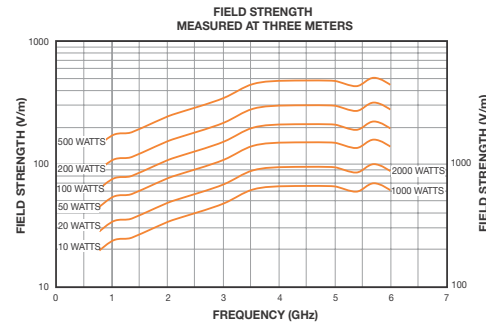
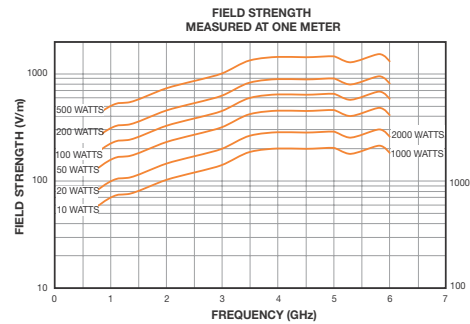

DRH-118

1–18 GHz
300 W

Impedance	50 ohms nominal
VSWR	< 1.5:1 average
Connector	Type N female
Polarization	Linear
Max Power	300 watts
Size (LxWxH)	9 x 9.5 x 6 in., 23 x 24 x 15 cm
Weight	4 lb., 1.8 kg
Mount	¼-20 tripod mount Includes individual calibration.
Options	SunAR RF Motion SNAP! Mount Tripod Carrying case

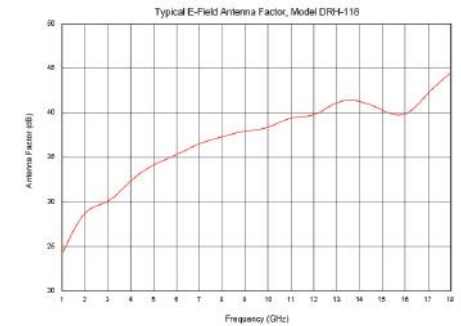
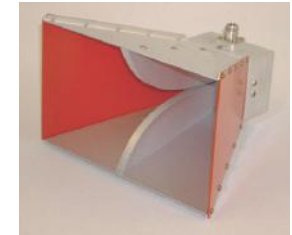

ATH2G10 2 – 10 GHz 700 W



Frequency range	2 – 10 GHz
Power input (max.)	700 W
Gain	12.5 dBi min., increasing to 23 dBi at 10 GHz
VSWR (max.)	
Max.	2:1
Average	1.5:1
Beamwidth (avg.) at 3 dBi down from peak	
E Plane	25°
H Plane	27°
Connector	N (F)
Size (w x h x d)	22.9 x 17.8 x 31.75 cm (9 x 7 x 12.5 in.)
Weight (max.)	1.59 kg (3.5 lb.)

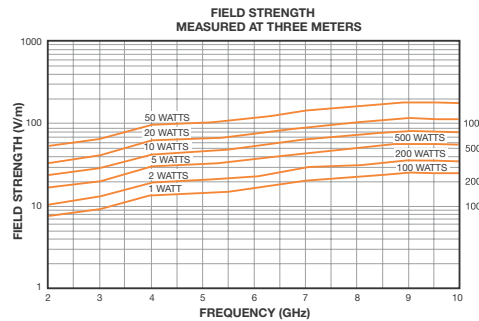
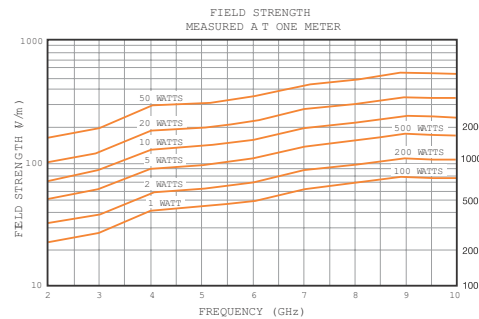

ATH4G8 4 – 8 GHz 500 W



Frequency range	4 – 8 GHz
Power input (max.)	500 W
Gain	11.5 dBi min., increasing to 15.9 dBi at 8 GHz
Max.	17.8 dBi min., increasing to 21.2 dBi at 8 GHz with gain enhancer
VSWR (max.)	
Max.	1.6:1
Average	1.3:1
Beamwidth (avg.) at 3 dBi down from peak	
E Plane	18° with gain enhancer
H Plane	18° with gain enhancer
Connector	N (F) Quick change connector
Size (w x h x d)	without gain enhancer 7.62 x 10.3 x 15.14 cm (30 x 46 x 5.96 in.) with gain enhancer: 21.6 x 21.6 x 30.5 cm (8.5 x 8.5 x 12 in.)
Weight (max.)	2.27 kg (5 lb.)

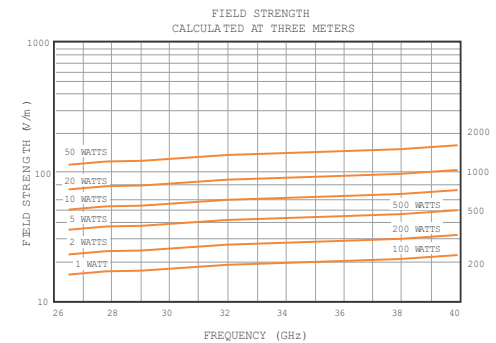
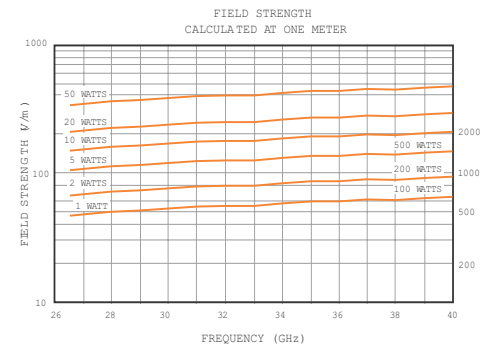

ATH6G18A 6 – 18 GHz 3000 W



Frequency Range:	6 – 18 GHz
Average Power Input:	3000 W maximum
Peak Power Input:	Consult factory
Far Field Gain (over isotropic):	19–25 dBi (see curve)
VSWR:	1.5:1 Typical
Beam Width (3 dB):	17°–7°, E-Plane (see curve) 18°–9°, H-Plane (see curve)
Connector:	WRD–650 D28 waveguide, cover flange, alternating thru/tapped hole pattern
Weight:	1.13 kg (2.50 lbs)
Size:	19 x 13.8 x 33 cm (7.5 x 5.4 x 13 in)
Mounting Provision:	Tripod mounting bracket with ¼–20 tapped hole
Export Classification:	EAR99

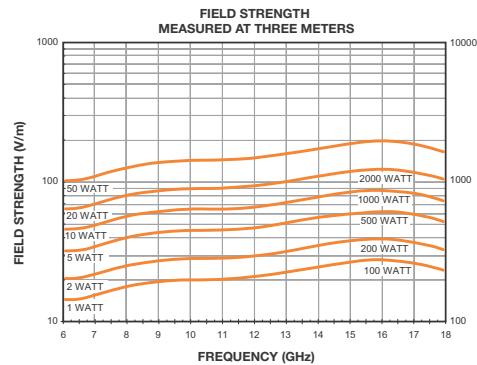
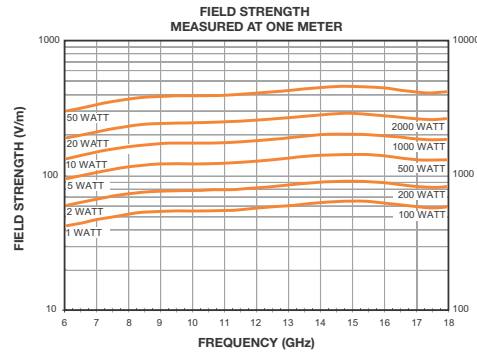

ATH7G18A 7.5 – 18 GHz 2800 W

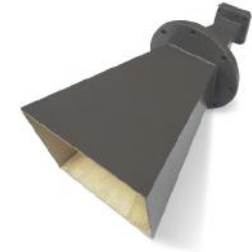

Frequency range	7.5 – 18 GHz
Power input (max.)	2,800 W
Gain	11.3 dBi min. increasing to 14 dBi at 18 GHz 17.4 dBi min., increasing to 20.2 dBi at 18 GHz with gain enhancer
VSWR (max.)	
Max.	1.2:1
Average	1.1:1
Beamwidth (avg.) at 3 dBi down from peak	
E Plane	17° with gain enhancer
H Plane	17° with gain enhancer
Connector	WRD–750 waveguide
Size (w x h x d)	with gain enhancer: 9 x 10.8 x 20.6 cm (3.54 x 4.25 x 8.11 in).
Weight (max.)	0.6 kg (1.25 lb.)

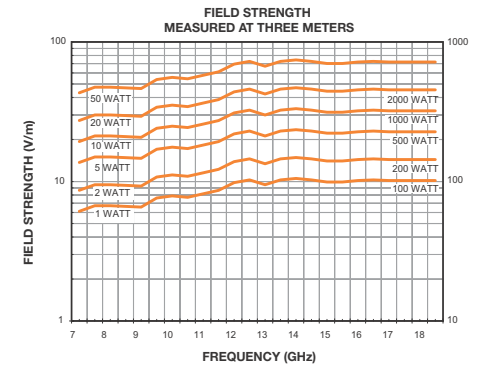
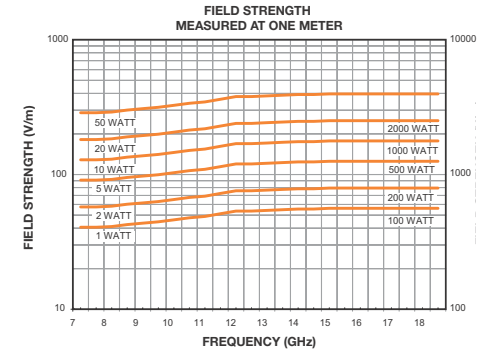

ATH18G27A 18 – 26.5 GHz 350 W



Frequency range	18 – 26.5 GHz
Power input (max.)	350 W CW
Gain	See Graph
VSWR (max.)	Typical 1.25:1
Beamwidth (avg.)	See Graph
Connector	WRD 180 C24 waveguide
Size (w x h x d)	6.43 x 53 x 9 cm (2.53 x 1.98 x 3.54 in)
Weight (max.)	150 g (5.3 oz)

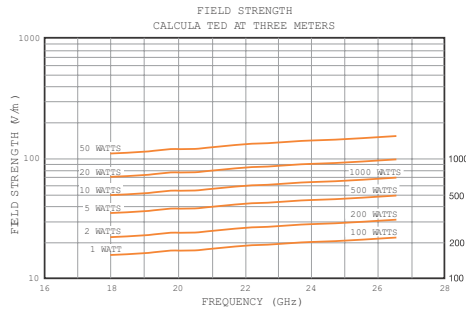
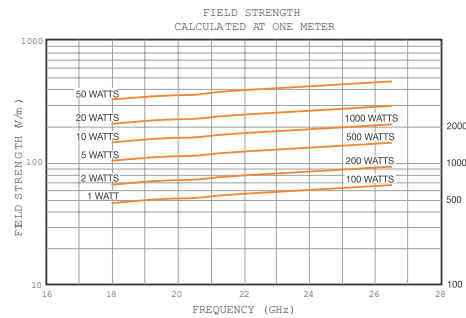

ATH18G27A-1 18 – 26.5 GHz 350 W



Frequency range	18 – 26.5 GHz
Power input (max.)	350 W CW
Gain	8.8 dBi min, increasing to 11.3 dBi at 26.5 GHz.
VSWR (max.)	
Max.	1.4:1
Average	1.2:1
Beamwidth (avg.)	
E Plane	57°
H Plane	55°
Connector	WR-42 waveguide
Size (w x h x d)	2.2 x 2.2 x 3.2 cm (0.88 x 0.88 x 1.25 in.)
Weight (max.)	241 g (8.5 oz)

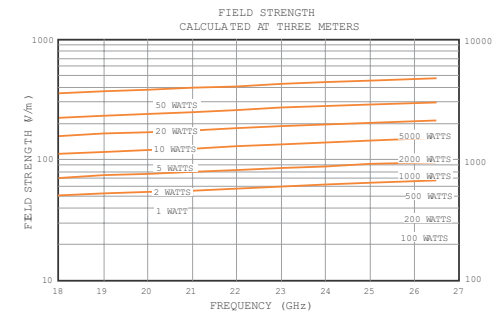
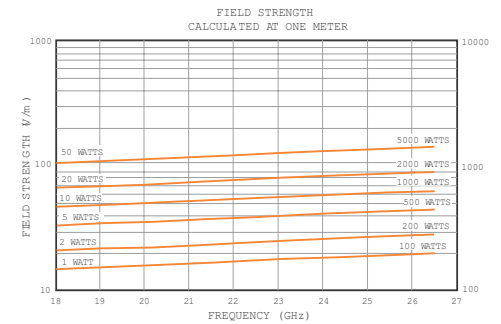

DRH-1840 18 - 40 GHz 50 W



Impedance	50 ohms nominal
VSWR	< 1.5:1 average
Connector	Type K female
Polarization	Linear
Max Power	50 watts
Size (LxWxH)	5 x 5 x 3 in., 13 x 13 x 8 cm
Weight	1 lb., .45 kg
Mount	¼-20 tripod mount Includes individual calibration.
Options	SunAR RF Motion SNAP! Mount Tripod Carrying case

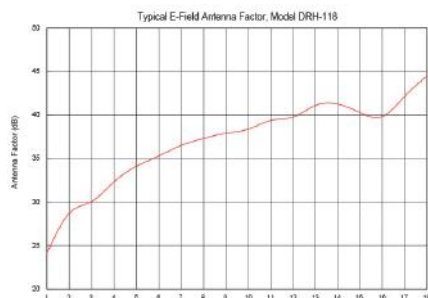

ATH18G40 18 - 40 GHz 450 W



Frequency range	18 - 40 GHz
Power input (max.)	450 W
Gain	See Graph
VSWR (max.)	
Max.	1.5:1
Average	1.3:1
Beamwidth (avg.)	See Graph
Connector	WRD 180 C24 waveguide
Size (w x h x d)	3.73 x 2.69 x 6.27 cm (1.47 x 1.06 x 2.47 in.)
Weight (max.)	56.7 g (2 oz)

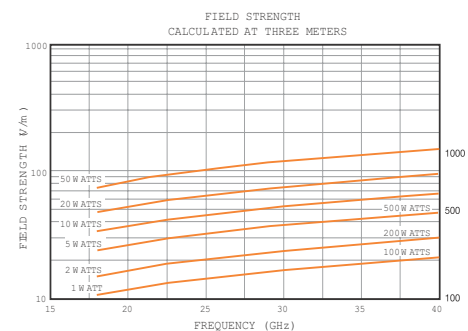
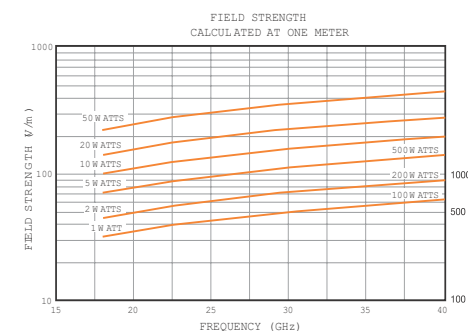

ATH26G40A-1 26.5 – 40 GHz 240 W



Frequency range	26.5 – 40 GHz
Power input (max.)	240 W
Gain (over isotropic)	9 dBi min, increasing to 12 dBi at 40 GHz.
VSWR (typ.)	
Max.	1.3:1
Average	1.2:1
Beamwidth (avg.) at 3 dBi down from peak	
E Plane	57.5°
H Plane	56.5°
Connector	WR-28 waveguide
Size (w x h x d)	1.9 x 1.9 x 2.54 cm (0.75 x 0.75 x 10 in.)
Weight	122 g (4.3 oz)

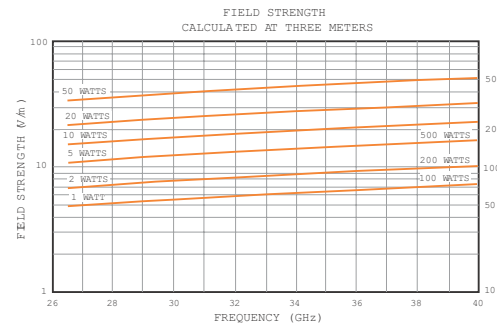
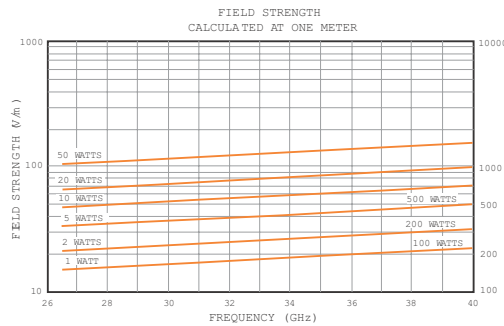

ATH26G40A 26.5 – 40 GHz 400 W



Frequency Range:	26.5 – 40 GHz
Power Input (maximum):	400 watts CW
Power Gain	(over isotropic): See Curve
VSWR:	Typical 1.25:1
Beamwidth (average):	See curve
Connector:	WR-28 waveguide
Mounting Provisions:	Waveguide flange
Weight:	50 g (1.8 oz)
Size (W X H X D):	3.19 X 44 X 7 Cm (1.26 X 1.59 X 2.76 In)
Export Classification:	EAR99

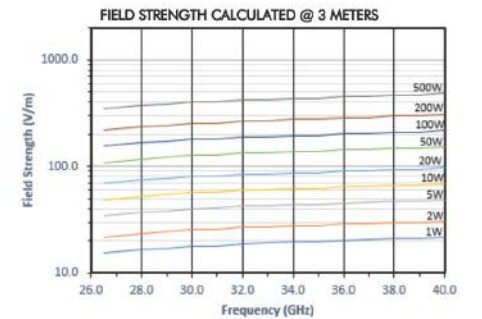
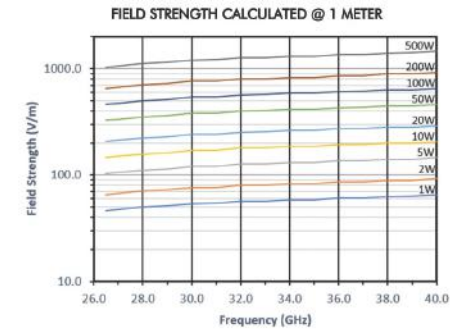

ATH33G50 33 – 50 GHz 240 W



Frequency range	33 GHz – 50 GHz
Power input (max.)	240 W
Gain (over isotropic)	20 ± 2 dBi
VSWR (typ.)	
Max.	
Average	1.2:1
Beamwidth (avg.) at 3 dBi down from peak	
E Plane	9.85°
H Plane	11.9°
Connector	WR-22 waveguide
Size (w x h x d)	4 x 3 x 9 cm (1.57 x 1.18 x 3.54 in.)
Weight	0.15 kg (0.33 lb.)

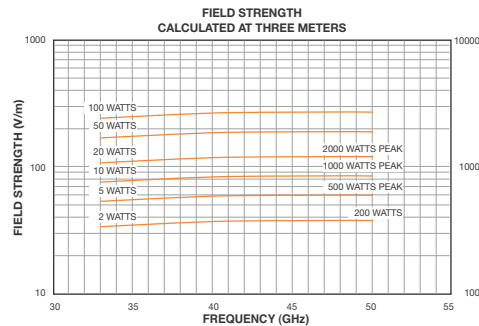
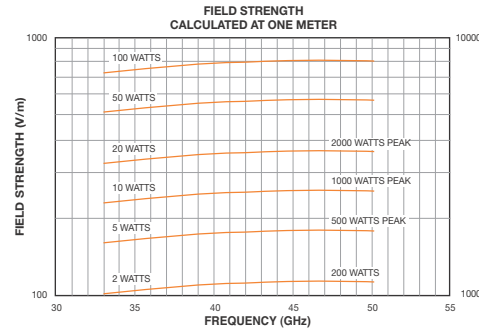

ATE10K25M-1 10 kHz – 25 MHz 3000 W



Frequency Range	10 kHz – 25 MHz
Power Input (max)	3000 W CW
Impedance	50 ohms
VSWR	2:1 max., 10 kHz–20 MHz 3.5:1 max., 20 MHz–25 MHz
Electric Field Intensity	200 volts/meter
Connector*	Type C (F)
Size (W x H x D)	303.53 x 222.25 x 101.8 cm (119.5 x 87.5 x 40 in.)
Weight (max.)	113 kg (250 lb.)

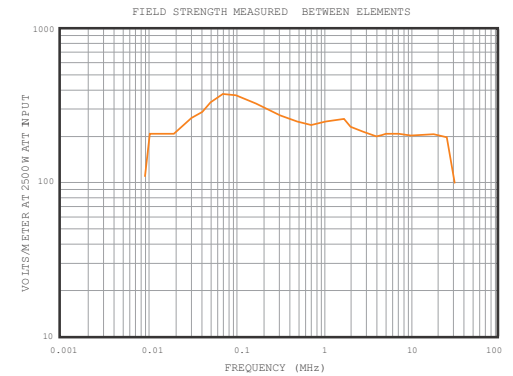

ATE10K30MA 10 kHz – 30 MHz 1000 W



Frequency range 10 kHz – 30 MHz

Power Input (max)
without cooling option* 1000 W continuous
with forced-air cooling option* 3000 W, 50% duty cycle

VSWR
10 kHz–15 MHz 2:1 Max
15 MHz–22 MHz 3:1 Max
22 MHz–30 MHz 5:1 Max

Electric Field Intensity See graph.

Mounting Provisions UNC 1/4–20 tripod thread on 2 sides
(optional tripod available)

Size 188 x 72 x 7 cm (74 x 28.3 x 2.5 in.)
(field-generating elements are removable for storage and transportation)

Weight
without cooling option 17 kg (38 lb.)
with forced-air cooling 21 kg (46 lb.)

Connector Type C(F) Quick Change

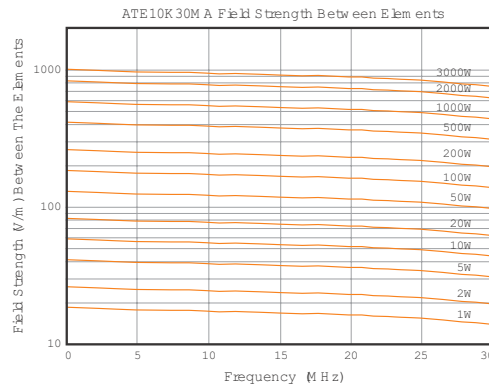

ATE10K100M 10 kHz – 100 MHz 500 W



Frequency range 10 kHz – 100 MHz

Power input 500 W max.

Input Impedance 50 ohms nominal

VSWR 2.5:1 max., 1.4:1 typical

Electric field intensity See graphs.

Field Intensity
between Type A elements nominally 350 V/m with 500 W input
between Type B elements nominally 200 V/m with 500 W input

Max. Test Object Volume
between Type A elements 36 x 46 x 36 cm
(14 x 18 x 14 in.)
between Type B elements 48 x 46 x 36 cm
(19 x 18 x 14 in.)

Connector* Type N (F)

Size
with Type A elements 74 x 41 x 102 cm
(29 x 16 x 40 in.)
with Type B elements 104 x 41 x 102 cm
(41 x 16 x 40 in.)

Weight (max.) 13 kg (28 lb.)

Mounting Accepts tripod threaded
1/4 x 20 stud on three faces
(optional tripod available)

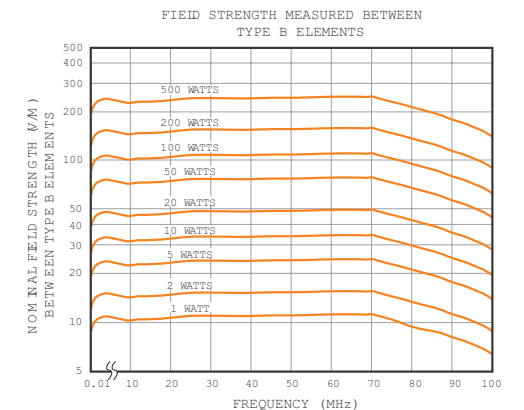
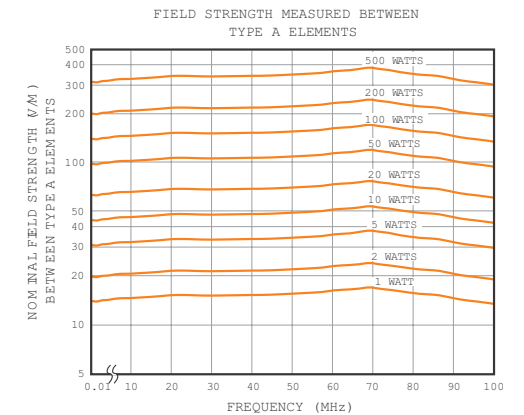

ATP10K100M 10 kHz – 100 MHz 3000 W

Frequency range	10 kHz – 100 MHz
Power input (max)	3000 W CW
Input impedance	50 ohms
VSWR	2:1 max. 10 kHz–100 MHz 6:1 max. 10–20 kHz above 1 kW input power
Electric field intensity	See Figure
Connector	See Model Configurations
Natural convection to 40°C ambient temperature	
Weight	95 kg (210 lb.)
Size (W x H x D)	265 x 240 x 120 cm (105 x 96 x 49 in)

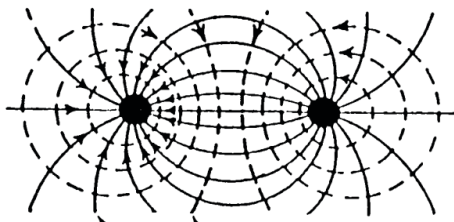
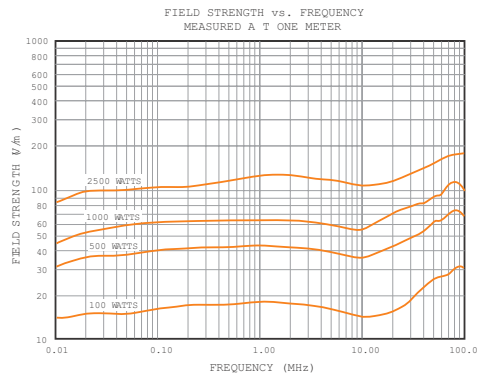
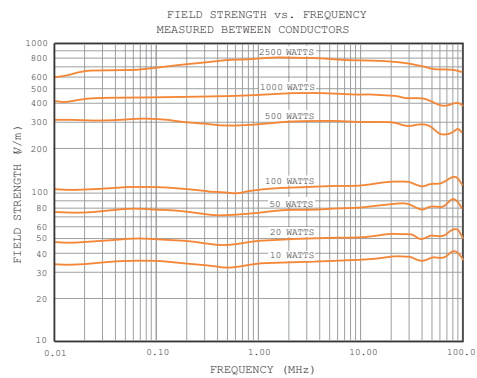
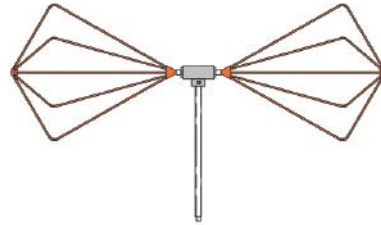

Fig. 1 E and H Field Pattern

BC1, BC3 & BC5 30–300 MHz



Impedance	50 ohms nominal
Connector	Type N female
Polarization	Linear
Max Power	BC1-1 watt CW max. BC2-50 watts CW max. BC5-500 watts CW max.
Elements	20 in. (51 cm) diameter
Size (LxH)	54 x 32 in, 81 x 137 cm
Weight	5 lbs. (2 kg)
Mounting Tube	22 mm dia. stainless steel
Finish	Orange powdercoat

LP425PCB 400 MHz – 3 GHz



Frequency Range	400 MHz – 3 GHz
Gain	5.5 dBi typical
Beamwidth	See figure at right
Impedance	50 ohms nominal
VSWR	< 2:1
Connector	Type N female
Polarization	Linear
Input Power	25 watts CW
Size (L x W x H)	39.4 x 29.2 x 1.27 cm, 15.5 x 11.5 x .5 in.
Pigtail Length	8 in.
Weight	2 lb. (0.7 kg)
Cover	UL94V0 flame rated
Standard Color	Polar White

Options

Custom pigtail length
 Mounting brackets
 7-16 DIN, 4.3-10 connectors
 PIM rated option
 Individual PIM testing
 Protective tray and cover

LP425PCB-O-DIN 400 MHz – 3 GHz



Frequency Range	400 MHz-3 GHz
Gain	5.5 dBi typical
Beamwidth	See figure at right
Impedance	50 ohms nominal
VSWR	< 2:1
Connector	DIN female
Polarization	Linear
Input Power	25 watts CW
Size (L x W x H)	39.4 x 29.2 x 1.27 cm, 15.5 x 11.5 x .5 in.
Pigtail Length	8 in.
Weight	2 lb. (0.7 kg)
Cover	UL94V0 flame rated
Standard Color	Polar White

Options

Custom pigtail length
 Custom covers and colors
 Mounting brackets

LP425 400 MHz – 3 GHz



Frequency Range	400 MHz – 3 GHz
Gain	7 dBi typical
Impedance	50 ohms nominal
VSWR	< 2:1
Connector	Type N female
Polarization	Linear
Power	200 watts CW max.
Size (L x W x H)	48 x 41 x 18 cm, 19 x 16 x 7 in.
Weight	2 lb. (1 kg)
Finish	Gold iridite

Options

Radome Cover (add suffix R)
Powder-coat finish (add suffix P)
7-16 DIN, 4.3-10 connectors

LP460PCB 400 MHz – 6 GHz



Frequency Range	400 MHz–6 GHz
Gain	5.6 dBi typical
Impedance	50 ohms nominal
VSWR	< 2:1
Connector	Type N female
Pigtail	RG-316
Polarization	Linear
Input Power	25 watts CW
Size (L x W x H)	36 x 25 x 1 cm, 14 x 10 x .375 in.
Weight	1.5 lb. (0.7 kg)
Cover	UL94V0 flame rated Kydex

LP6530PCB 650 MHz – 3 GHz



Frequency Range	650 MHz – 3 GHz
Gain	7 dBi typical
Beamwidth	See figure at right
Impedance	50 ohms nominal
VSWR	< 1.5:1
Connector	Type N female
Polarization	Linear
Input Power	25 watts CW
Size (L x W x H)	39.4 x 29.2 x 1.27 cm, 15.5 x 11.5 x .5 in.
Pigtail Length	8 in.
Weight	2 lb. (0.7 kg)
Cover	UL94V0 flame rated
Standard Color	Polar White

- Options
- Custom pigtail length
 - Mounting brackets
 - 7-16 DIN, 4.3-10 connectors
 - PIM rated option
 - Individual PIM testing
 - Protective tray and cover

LP6560PCB 650 MHz – 6 GHz



Frequency Range	650 MHz – 6 GHz
Gain	6 dBi typical (see table)
Beamwidth	See figure at right
Impedance	50 ohms nominal
VSWR	< 1.5:1
Connector	Type N female
Polarization	Linear
Input Power	15 watts CW
Size (L x W x H)	39.4 x 29.2 x 1.27 cm, 15.5 x 11.5 x .5 in.
Operating Temperature	-30°F to 150°F
Weight	2 lb. (0.7 kg)
Cover	UL94V0 flame rated Kydex
Standard Color	Polar White

- Options
- Custom pigtail length
 - Mounting brackets
 - 7-16 DIN, 4.3-10 connectors
 - PIM rated option
 - Individual PIM testing
 - Protective tray and cover

Accessories

AR offers a complete selection of test accessories that give you the most reliable results, such as probes, software, system controllers, couplers, and more. Many even make testing quicker, more efficient, and more accurate. They're all matched to our amplifiers to make your setup as easy as possible.

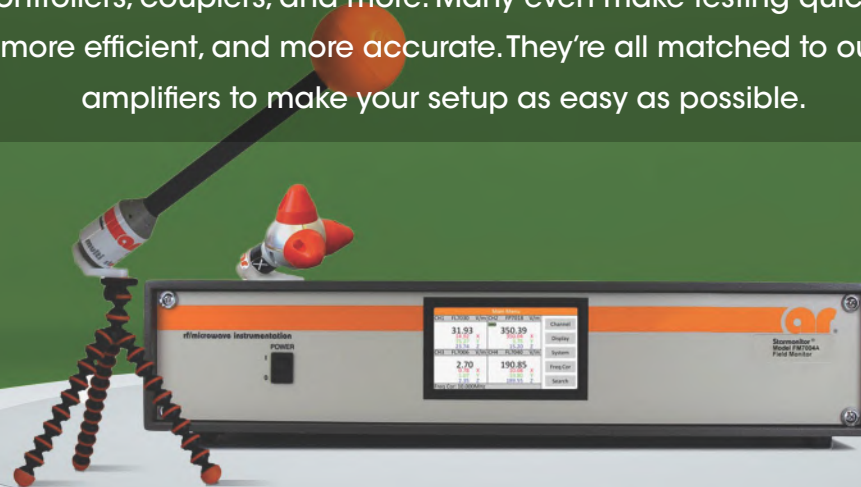

FL8000 Probes and FM7004A



CC1

Armored low-loss microwave cables for applications with frequencies less than 18 GHz. VSWR typically less than 1.35:1

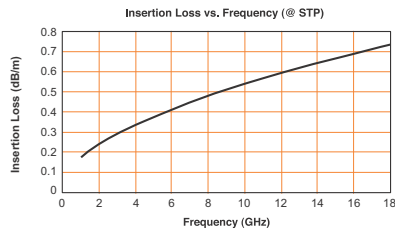
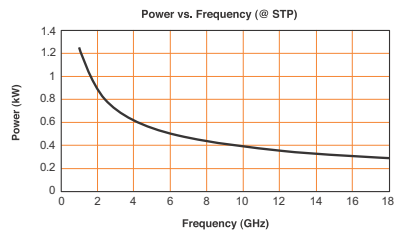

CC2

Armored low-loss microwave cables for applications with frequencies less than 40 GHz. VSWR is typically less than 1.45:1

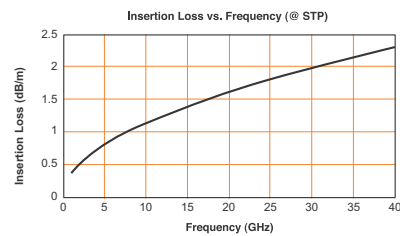
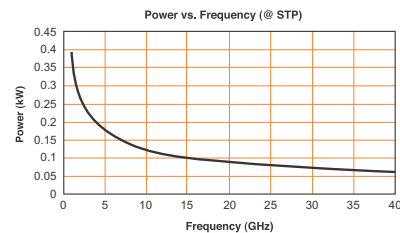

CC4

Recommended for AR's high power "A," "W," and "S" series amplifiers or other applications with frequencies less than 6 GHz. VSWR is typically less than 1.25:1.

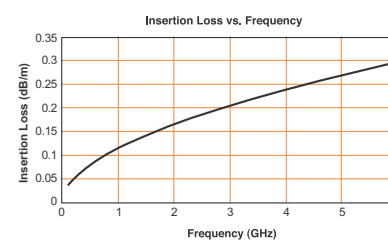
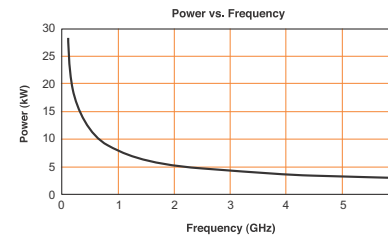

CC5

Low-loss microwave cables designed for higher power applications with frequencies up to 11 GHz. VSWR typically less than 1.25:1.

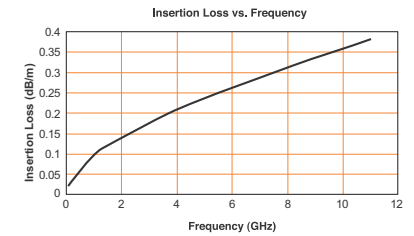
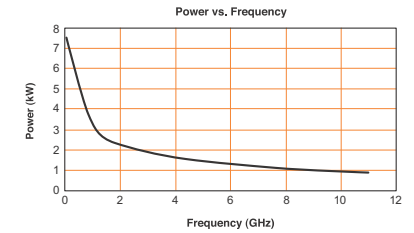

Amplifier	Dual Directional Coupler	Load Resistor or Attenuator
Universal Series Amplifiers		
1U1000	DC3010A	LA100
2.5U1000	DC3010A	LA100
5U1000	DC3010A	LA100
10U1000	DC3010A	LA100
25U1000	DC3010A	LA100
50U1000	DC3010A	LA100
100U1000A	DC3100A	LA150
150U1000	DC3100A	LA250
250U1000A	DC3100A	LA500
RF Solid State Amplifiers		
100A400AM20	DC3300A	LA150
800A3B	DC2500AM1	LA1000
150A100D	DC2500AM1	LA250
1200A225	DC2500AM2	LA4000
2500A225C	DC2035A	LA4000
5000A225C	DC4255	
10000A225B	DC4256	
12500A25A-L	DC4256	
25A250B	DC3010A	LA100
50A250	DC2600A	LA100
125A250	DC2600A	LA150
500A250D	DC2500AM1	LA1000
100A400A	DC3400A	LA150
175A400	DC3401A	LA250
250A400	DC3401A	LA500
350A400	DC3401A	LA500
600A400	DC3410A	LA1000
1000A400	DC3410A	LA4000
50W1000D	DC3001A	LA100
150W1000B	DC6080A	LA250

Amplifier	Dual Directional Coupler	Load Resistor or Attenuator
250W1000C	DC6180A	LA500
500W1000C	DC6180A	LA1000
750W1000B	DC6280AM1	LA1000
1000W1000H	DC6280AM1	LA4000
1500W1000A	DC6380	LA4000
2000W1000D	DC6380	LA100
3000W1000B	DC6380M1	LA4000
4000W1000B	DC6380M2	LA4000
6000W1000	DC6430	
10000W1000A	DC6440	
Microwave Amplifiers		
15S1G6	DC7205A	LA100
30S1G6C	DC7205A	LA100
75S1G6C	DC7205A	LA100
125S1G6C	DC7205A	LA150
250S1G6C	DC7230A	
350S1G6A	DC7210A	
500S1G6C	DC7215A	
125S1G2z5	DC7144A	LA150
250S1G2z5B	DC7144A	LA500
500S1G2z5A	DC7154AM1	LA1000
1000S1G2z5B	DC7164M1	
50A1G6AB	DC7200A	LA150
100S1G6AB	DC7200A	LA150
20S6G18A-L	DC7435AM1	LA100
40S6G18A-L	DC7435AM1	LA100
Solid State Pulsed Amplifiers		
2000SP0z8G2z5	DC7154A	
4000SP0z8G2z5	DC7154A	
8000SP0z8G2z5	DC7128A	

Amplifier	Dual Directional Coupler	Load Resistor or Attenuator
1300SP1G2	DC7154A	
2000SP1G2	DC7154A	
4000SP1G2	DC7128A	
8000SP1G2	DC7128A	
4000SP1z2G1z4	DC7128A	
5000SP1z2G1z4	DC7128A	
1500/1000SP1z2G3z1	DC7154A	
1000SP2G4	DC7154A	
2000SP2G4	DC7154A	
5000SP2G4	DC7154AM1	
7000SP2G4	DC7154AM1	
10000SP2G4	DC7154AM1	
15000SP2G4	Call Factory	
20000SP2G4	Call Factory	
4000SP2z7G3z1	Call Factory	
12000SP2z7G3z1	Call Factory	
TWT Amplifiers		
300T2G8	DC7281A	LR2000M1
500T2G8	DC7281A	LR2000M1
1000T2G8B	DC7276M1	LR2000M1
1500T2G8A	DC7276M1	LR2000M1
200T4G8	DC7281A	
250T6G18	DC7445	
250T8G18	DC7450M1	LR1500M1
500T8G18	DC7450M1	LR1500M1
1000T8G18B	DC7450M1	LR1500M1
1500T8G18	DC7450M1	LR1500M1
40T18G26A	DC7530	
130T18G26z5B	DC7530	
200T18G26z5A	DC7530	
40T26G40A	DC7620	

Amplifier	Dual Directional Coupler	Load Resistor or Attenuator
130T26z5G40B	DC7620	
200T26z5G40A	DC7620	
70T40G50	DC7820	
100T40G50	DC7820	
1000TP8G18	DC7450M1	LR1500M1
2000TP2G8B	DC7281A	LR2000M1
2000TP8G18	DC7450M1	
4000TP2G4	DC7281A	LA500
12000TP2G4	DC7281A	
4000TP4G8	DC7351	
12000TP4G8	DC7351	
4000TP8G12	DC7490	
20000TP8G12	DC7490	
3000TP12G18	DC7462	
5700TP12G18	DC7462	
6900TP2G4	DC7154AM1	
7400TP4G8	DC7351	
8000TP2z7G3z1	DC7154AM1	
8300TP8G12	DC7490	
10000TP8G10	DC7490M1	

DC3300A

4 kHz – 400 MHz
250 W



Frequency Range	4 kHz – 400 MHz
Power (max. W)	250 CW
Flatness (max.)	50 ± 1.5 dB (4 – 10 kHz) 50 ± .75 dB (0.01 – 400 MHz)
Coupling Factor (includes flatness)	50 ± 1.5 dB (4 – 10 kHz) 50 ± 1 dB (0.01 – 400 MHz)
Directivity	
typical	20 dB
minimum	15 dB
Insertion Loss (max.)	0.2 dB
VSWR (main line)	1.2:1 max.
Connectors	
main line (J1/J2)	N(M)/N(F)
coupled (J3/J4)	N(F)/N(F)
Weight (max.)	0.36 kg 0.8 lb.
Size (approx.) W x H x D	19.3 x 5.1 x 5.6 cm (7.6 x 2 x 2.2 in.)

DC3510A

9 kHz – 1000 MHz
200 W



Frequency Range	9 kHz – 1000 MHz
Power (max. W)	200 CW
Flatness (max.)	± 0.6 dB
Coupling Factor (includes flatness)	40 ± 0.8 dB
Directivity	
typical	25 dB
minimum	20 dB (0.01 – 1000 MHz) 15 dB (0.009 – 0.01 MHz)
Insertion Loss (max.)	0.5 dB
VSWR (main line)	1.3:1 max.
Connectors	
main line (J1/J2)	N(M)/N(F)
coupled (J3/J4)	N(F)/N(F)
Weight (max.)	1.36 kg 3 lb.
Size (approx.) W x H x D	15.7 x 5.8 x 4.3 cm (6.2 x 2.28 x 1.69 in.)

DC2500AM1

10 kHz – 250 MHz
1000 W



Frequency Range	10 kHz – 250 MHz
Power (max. W)	1000 CW
Flatness (max.)	± 0.9 dB
Coupling Factor (includes flatness)	50 ± 1 dB
Directivity	
typical	25 dB
minimum	20 dB (20 kHz–250 MHz) 18 dB (10 kHz–20 kHz)
Insertion Loss (max.)	0.22 dB
VSWR (main line)	1.2:1 max.
Connectors	
main line (J1/J2)	N(M)/N(F)
coupled (J3/J4)	N(F)/N(F)
Weight (max.)	1.13 kg 2.5 lb.
Size (approx.) W x H x D	26.6 x 8.1 x 7.6 cm (10.1 x 3.2 x 3 in.)

DC2035A

10 kHz – 250 MHz
3500 W



Frequency Range	10 kHz – 250 MHz
Power (max. W)	3,500 CW
Flatness (max.)	± 0.9 dB
Coupling Factor (includes flatness)	50 ± 1 dB
Directivity	
typical	25 dB
minimum	20 dB
Insertion Loss (max.)	0.30 dB
VSWR (main line)	1.2:1 max.
Connectors	
main line (J1/J2)	7–16(M)/7–16(F)
coupled (J3/J4)	N(F)/N(F)
Weight (max.)	1.8 kg 4 lb.
Size (approx.) W x H x D	25.4 x 8.9 x 11.7 cm (10 x 3.5 x 4.6 in.)

DC4255*

10 kHz – 250 MHz
10000 W



Frequency Range	10 kHz – 250 MHz
Power (max. W)	10000 CW
Flatness (max.)	± 1 dB
Coupling Factor (includes flatness)	60 ± 1 dB
Directivity	
typical	25 dB
minimum	20 dB
Insertion Loss (max.)	0.1 dB
VSWR (main line)	1.20:1 max.
Connectors	
main line (J1/J2)	EIA fixed flanges 1 5/8 in. EIA (M)
coupled (J3/J4)	N(F)/N(F)
Weight (max.)	7 kg 15.5 lb.
Size (approx.) W x H x D	15.2 x 11.4 x 30.48 cm (6 x 4.5 x 12 in.)

*Power required for fan cooling."

DC4256*

10 kHz – 250 MHz
13000 W



Frequency Range	10 kHz – 250 MHz
Power (max. W)	13000 CW
Flatness (max.)	± 1 dB
Coupling Factor (includes flatness)	60 ± 1 dB
Directivity	
typical	25 dB
minimum	20 dB
Insertion Loss (max.)	0.1 dB
VSWR (main line)	1.20:1 max.
Connectors	
main line (J1/J2)	EIA fixed flanges 1 5/8 in. EIA (M)
coupled (J3/J4)	N(F)/N(F)
Weight (max.)	7 kg 15.5 lb.
Size (approx.) W x H x D	15.24 x 11.43 x 32.38 cm (6 x 4.5 x 12.75 in.)

*Power required for fan cooling."

DC3400A

10 kHz – 400 MHz
250 W



Frequency Range	10 kHz – 400 MHz
Power (max. W)	250 CW
Flatness (max.)	± 0.5 dB
Coupling Factor (includes flatness)	40 ± 1 dB
Directivity	
typical	25 dB
minimum	20 dB
Insertion Loss (max.)	0.5 dB
VSWR (main line)	1.3:1 max.
Connectors	
main line (J1/J2)	N(M)/N(F)
coupled (J3/J4)	N(F)/N(F)
Weight (max.)	0.8 kg 1.8 lb.
Size (approx.) W x H x D	13.2 x 6.8 x 4.1 cm (5.2 x 2.7 x 1.6 in.)

DC3401A

10 kHz – 400 MHz
500 W



Frequency Range	10 kHz – 400 MHz
Power (max. W)	500 CW
Flatness (max.)	± 0.6 dB
Coupling Factor (includes flatness)	50 dB ± 0.8 dB
Directivity	
typical	25 dB
minimum	20 dB
Insertion Loss (max.)	0.5 dB
VSWR (main line)	1.30:1 max.
Connectors	
main line (J1/J2)	N(M)/N(F)
coupled (J3/J4)	N(F)/N(F)
Weight (max.)	0.8 kg 1.8 lb.
Size (approx.) W x H x D	13.2 x 6.8 x 4.32 cm (5.2 x 2.7 x 1.7 in.)

DC3410A

10 kHz – 400 MHz
2000 W



Frequency Range	10 kHz - 400 MHz
Power (max. W)	2000 CW
Flatness (max.)	± 1 dB
Coupling Factor (includes flatness)	50 dB ± 1dB
Directivity	
typical	20 dB
minimum	20 dB
Insertion Loss (max.)	0.15 dB max.
VSWR (main line)	1.2:1 max.
Connectors	
main line (J1/J2)	7 - 16 (M)/7 - 16 (F)
coupled (J3/J4)	N(F)/N(F)
Weight (max.)	1.25 kg 2.75 lb.
Size (approx.) W x H x D	18.3 x 5.6 x 6.9 cm (7.2 x 2.2 x 2.71 in)

DC3010A

10 kHz – 1000 MHz
100 W



Frequency Range	10 kHz – 1000 MHz
Power (max. W)	100 CW
Flatness (max.)	± 0.6 dB
Coupling Factor (includes flatness)	40 ± 0.8 dB
Directivity	
typical	25 dB
minimum	20 dB
Insertion Loss (max.)	0.6 dB
VSWR (main line)	1.3:1 max.
Connectors	
main line (J1/J2)	N(M)/N(F)
coupled (J3/J4)	N(F)/N(F)
Weight (max.)	0.9 kg 2 lb.
Size (approx.) W x H x D	12.7 x 5.1 x 3.8 cm (5 x 2 x 1.5 in.)

DC3100A

10 kHz – 1000 MHz
500 W



Frequency Range	10 kHz – 1000 MHz
Power (max. W)	500 CW
Flatness (max.)	± 0.5 dB
Coupling Factor (includes flatness)	40 ± 1.5 dB
Directivity	
typical	25 dB
minimum	20 dB
Insertion Loss (max.)	0.45 dB
VSWR (main line)	1.30:1 max.
Connectors	
main line (J1/J2)	N(M)/N(F)
coupled (J3/J4)	N(F)/N(F)
Weight (max.)	1.1 kg 2.5 lb.
Size (approx.) W x H x D	17 x 5.8 x 4.3 cm (6.7 x 2.27 x 1.69 in.)

DC3001A

100 kHz – 1000 MHz
100 W



Frequency Range	100 kHz – 1000 MHz
Power (max. W)	100 CW
Flatness (max.)	± 0.6 dB
Coupling Factor (includes flatness)	40 ± 0.8 dB
Directivity	
typical	25 dB
minimum	20 dB
Insertion Loss (max.)	0.6 dB
VSWR (main line)	1.3:1 max.
Connectors	
main line (J1/J2)	N(M)/N(F)
coupled (J3/J4)	N(F)/N(F)
Weight (max.)	0.39 kg 0.86 lb.
Size (approx.) W x H x D	12.7 x 5.1 x 3.8 cm (5 x 2 x 1.5 in)

DC6080A

80 – 1000 MHz
500 W



Frequency Range	80 – 1000 MHz
Power (max. W)	500 CW
Flatness (max.)	± 0.5 dB
Coupling Factor (includes flatness)	40 ± 1 dB
Directivity	
typical	25 dB
minimum	20 dB
Insertion Loss (max.)	0.25 dB
VSWR (main line)	1.2:1 max.
Connectors	
main line (J1/J2)	N(M)/N(F)
coupled (J3/J4)	N(F)/N(F)
Weight (max.)	0.45 kg 1 lb.
Size (approx.) W x H x D	7.62 x 7.62 x 2.77 cm (3 x 3 x 1.09 in.)

DC6180A

80 – 1000 MHz
600 W



Frequency Range	80 – 1000 MHz
Power (max. W)	600 CW
Flatness (max.)	± 0.5 dB
Coupling Factor (includes flatness)	60 ± 1 dB
Directivity	
typical	25 dB
minimum	20 dB
Insertion Loss (max.)	0.15 dB
VSWR (main line)	1.20:1 max.
Connectors	
main line (J1/J2)	N(M)/N(F)
coupled (J3/J4)	N(F)/N(F)
Weight (max.)	0.6 kg 1.2 lb.
Size (approx.) W x H x D	10.9 x 6.3 x 3.2 cm (4.3 x 2.5 x 1.3 in.)

DC6280AM1

80 – 1000 MHz
1500 W



Frequency Range	80 – 1000 MHz
Power (max. W)	1,500 CW
Flatness (max.)	±0.5 dB
Coupling Factor (includes flatness)	63 ± 1 dB
Directivity	
typical	25 dB
minimum	20 dB
Insertion Loss (max.)	0.15 dB
VSWR (main line)	1.2:1 max.
Connectors	
main line (J1/J2)	7-16(M)/7-16(F)
coupled (J3/J4)	N(F)/N(F)
Weight (max.)	0.6 kg 1.2 lb.
Size (approx.) W x H x D	10.9 x 6.3 x 3.2 cm (4.3 x 2.5 x 1.3 in.)

DC6380

80 – 1000 MHz
3000 W



Frequency Range	80 – 1000 MHz
Power (max. W)	3000 CW
Flatness (max.)	± 1 dB
Coupling Factor (includes flatness)	65 dB ± 1.5 dB
Directivity	
typical	25 dB
minimum	20 dB
Insertion Loss (max.)	0.15 dB
VSWR (main line)	1.5:1 max.
Connectors	
main line (J1/J2)	EIA fixed flanges 1 5/8 in. EIA (M)
coupled (J3/J4)	N(F)/N(F)
Weight (max.)	1.8 kg 4 lb.
Size (approx.) W x H x D	20.3 x 8.9 x 10.2 cm (8 x 3.5 x 4 in.)

DC6380M1

80 – 1000 MHz
4500 W



Frequency Range	80 – 1000 MHz
Power (max. W)	4500 CW
Flatness (max.)	± 1 dB
Coupling Factor (includes flatness)	68 ± 1.5 dB
Directivity	
typical	25 dB
minimum	20 dB
Insertion Loss (max.)	0.15 dB
VSWR (main line)	1.5:1 max.
Connectors	
main line (J1/J2)	EIA fixed flanges 1 ⁵ / ₈ in. EIA (M)
coupled (J3/J4)	N(F)/N(F)
Weight (max.)	1.8 kg 4 lb.
Size (approx.) W x H x D	20.3 x 8.9 x 10.2 cm (8 x 3.5 x 4 in.)

DC6380M2

80 – 1000 MHz
7000 W



Frequency Range	80 – 1000 MHz
Power (max. W)	7000 CW
Flatness (max.)	± 1 dB
Coupling Factor (includes flatness)	70 ± 1.5 dB
Directivity	
typical	25 dB
minimum	20 dB
Insertion Loss (max.)	0.15 dB
VSWR (main line)	1.5:1 max.
Connectors	
main line (J1/J2)	EIA fixed flanges 1 ⁵ / ₈ in. EIA (M)
coupled (J3/J4)	N(F)/N(F)
Weight (max.)	1.8 kg 4 lb.
Size (approx.) W x H x D	20.3 x 8.9 x 10.2 cm (8 x 3.5 x 4 in.)

DC6430

80 – 1000 MHz
15000 W



Frequency Range	80 – 1000 MHz
Power (max. W)	15000 CW
Flatness (max.)	± 1 dB
Coupling Factor (includes flatness)	68 dB
Directivity	
typical	20 dB
minimum	18 dB
Insertion Loss (max.)	0.1 dB
VSWR (main line)	1.15:1 max.
Connectors	
main line (J1/J2)	EIA fixed flanges 3 ¹ / ₈ in. EIA (M)
coupled (J3/J4)	N(F)/N(F)
Weight (max.)	3 kg 6.6 lb.
Size (approx.) W x H x D	15.2 x 13.2 cm (6 x 5.2 in.)

DC6440

80 – 1000 MHz
15000 W



Frequency Range	80 – 1000 MHz
Power (max. W)	15000 CW
Flatness (max.)	± 1 dB
Coupling Factor (includes flatness)	70 dB
Directivity	
typical	20 dB
minimum	18 dB
Insertion Loss (max.)	0.1 dB
VSWR (main line)	1.10:1 max.
Connectors	
main line (J1/J2)	EIA fixed flanges 4 ¹ / ₁₆ in. EIA (m)
coupled (J3/J4)	N(F)/N(F)
Weight (max.)	3.5 kg 7.7 lb.
Size (approx.) W x H x D	15.2 x 15.8 cm (6 x 6.2 in.)

DC7144A 0.7 – 4.2 GHz 400 W



Frequency Range	0.7 – 4.2 GHz
Power (max. W)	400 CW
Flatness (max.)	± 0.8 dB
Coupling Factor (includes flatness)	40 ± 1.3 dB
Directivity	
typical	19 dB
minimum	15 dB
Insertion Loss (max.)	0.4 dB
VSWR (main line)	1.25:1 max.
Connectors	
main line (J1/J2)	N(M)/N(F)
coupled (J3/J4)	N(F)/N(F)
Weight (max.)	0.24 kg 0.525 lb.
Size (approx.) W x H x D	2.35 x 5.84 x 19 cm (0.925 x 2.3 x 7.48 in.)

DC7154A 0.7 – 4.2 GHz 400 W



Frequency Range	0.7 – 4.2 GHz
Power (max. W)	400 CW
Flatness (max.)	± 0.8 dB
Coupling Factor (includes flatness)	50 ± 1.3 dB
Directivity	
typical	19 dB
minimum	15 dB
Insertion Loss (max.)	0.4 dB
VSWR (main line)	1.25:1 max.
Connectors	
main line (J1/J2)	N(M)/N(F)
coupled (J3/J4)	N(F)/N(F)
Weight (max.)	0.29 kg 0.64 lb.
Size (approx.) W x H x D	3.2 x 6.3 x 10.9 cm (1.3 x 2.5 x 4.3 in.)

DC7154AM1 0.7 – 4.2 GHz 700 W



Frequency Range	0.7 – 4.2 GHz
Power (max. W)	700 CW
Flatness (max.)	± 0.8 dB
Coupling Factor (includes flatness)	50 ± 1.3 dB
Directivity	
typical	19 dB
minimum	15 dB
Insertion Loss (max.)	0.4 dB
VSWR (main line)	1.25:1 max.
Connectors	
main line (J1/J2)	7–16(M)/7–16(F)
coupled (J3/J4)	N(F)/N(F)
Weight (max.)	0.29 kg 0.64 lb.
Size (approx.) W x H x D	3.2 x 6.3 x 10.9 cm (1.3 x 2.5 x 4.3 in.)

DC7205A 0.7 – 6 GHz 250 W



Frequency Range	0.7 – 6GHz
Power (max. W)	250 CW
Flatness (max.)	± 0.8 dB
Coupling Factor (includes flatness)	41 ± 1.2 dB
Directivity	
typical	18 dB
minimum	15 dB
Insertion Loss (max.)	0.2 dB
VSWR (main line)	1.2:1 max.
Connectors	
main line (J1/J2)	N(M)/N(F)
coupled (J3/J4)	N(F)/N(F)
Weight (max.)	0.27 kg 0.6 lb.
Size (approx.) W x H x D	6.8 x 5.1 x 3.05 cm (2.7 x 2 x 1.2 in.)

DC7210A

0.7 – 4.2 GHz
500 W



Frequency Range	0.7 – 4.2 GHz
Power (max. W)	500 CW
Flatness (max.)	± 1 dB
Coupling Factor (includes flatness)	50 ± 1.2 dB
Directivity	
typical	18 dB
minimum	15 dB
Insertion Loss (max.)	0.2 dB
VSWR (main line)	1.35:1 max.
Connectors	
main line (J1/J2)	7–16(M)/7–16(F)
coupled (J3/J4)	N(F)/N(F)
Weight (max.)	0.27 kg 0.6 lb.
Size (approx.) W x H x D	54.6 x 50.8 x 34.5 mm (2.15 x 2 x 1.36 in.)

DC7230A

0.7 – 6 GHz
500 W



Frequency Range	0.7 – 6GHz
Power (max. W)	500 CW
Flatness (max.)	± 0.5 dB
Coupling Factor (includes flatness)	48 ± 1.5 dB
Directivity	
typical	20 dB
minimum	15 dB
Insertion Loss (max.)	0.2 dB
VSWR (main line)	1.35:1 max.
Connectors	
main line (J1/J2)	N(M)/N(F)
coupled (J3/J4)	N(F)/N(F)
Weight (max.)	0.27 kg 0.6 lb.
Size (approx.) W x H x D	5.1 x 5.1 x 2.7 cm (2 x 2 x 1.06 in.)

DC7215A

0.7 – 6 GHz
750 W



Frequency Range	0.7 – 6 GHz
Power (max. W)	750 CW
Flatness (max.)	± 0.5 dB
Coupling Factor (includes flatness)	50 dB ± 1.5 dB
Directivity	
typical	18 dB
minimum	15 dB
Insertion Loss (max.)	0.2 dB
VSWR (main line)	1.45:1 max.
Connectors	
main line (J1/J2)	7–16(M)/7–16(F)
coupled (J3/J4)	N(F)/N(F)
Weight (max.)	0.27 kg 0.6 lb.
Size (approx.) W x H x D	5.5 x 5.1 x 3.5 cm (2.15 x 2 x 1.36 in.)

DC7128A

0.8 – 2.8 GHz
1500 W



Frequency Range	0.8 – 2.8 GHz
Power (max. W)	1500 CW
Flatness (max.)	± 0.8 dB
Coupling Factor (includes flatness)	50 ± 1 dB
Directivity	
typical	25 dB
minimum	20 dB
Insertion Loss (max.)	0.2 dB
VSWR (main line)	1.3:1 max.
Connectors	
main line (J1/J2)	7–16(M)/7–16(F)
coupled (J3/J4)	N(F)/N(F)
Weight (max.)	0.7 kg 1.5 lb.
Size (approx.) W x H x D	7.6 x 7.6 x 2.9 cm (3 x 3 x 1.125 in.)

DC7164M1

0.8 – 4.2 GHz
1400 W



DC7164

0.8 – 4.2 GHz
700 W



DC7200A

1 – 6 GHz
250 W



DC7240A

1 - 6 GHz
900 W



Frequency Range	0.8 – 4.2 GHz
Power (max. W)	1400 CW
Flatness (max.)	± 0.8 dB
Coupling Factor (includes flatness)	65 ± 1 dB
Directivity	
typical	19 dB
minimum	15 dB
Insertion Loss (max.)	0.4 dB
VSWR (main line)	1.25:1 max.
Connectors	
main line (J1/J2)	7/8 EIA
coupled (J3/J4)	N(F)/N(F)
Weight (max.)	0.91 kg 2 lb.
Size (approx.) W x H x D	5.71 x 8.25 x 15.25 cm (2.25 x 3.25 x 6 in.)

Frequency Range	0.8 – 4.2 GHz
Power (max. W)	700 CW
Flatness (max.)	± 0.8 dB
Coupling Factor (includes flatness)	60 ± 1 dB
Directivity	
typical	19 dB
minimum	15 dB
Insertion Loss (max.)	0.4 dB
VSWR (main line)	1.25:1 max.
Connectors	
main line (J1/J2)	7/8 EIA
coupled (J3/J4)	N(F)/N(F)
Weight (max.)	0.91 kg 2 lb.
Size (approx.) W x H x D	5.71 x 8.25 x 15.25 cm (2.25 x 3.25 x 6 in.)

Frequency Range	1 – 6 GHz
Power (max. W)	250 CW
Flatness (max.)	± 0.8 dB
Coupling Factor (includes flatness)	40 ± 1.2 dB
Directivity	
typical	18 dB
minimum	15 dB
Insertion Loss (max.)	0.2 dB
VSWR (main line)	1.2:1 max.
Connectors	
main line (J1/J2)	N(M)/N(F)
coupled (J3/J4)	N(F)/N(F)
Weight (max.)	0.27 kg 0.6 lb.
Size (approx.) W x H x D	6.8 x 5.1 x 3.05 cm (2.7 x 2 x 1.2 in.)

Frequency Range	1 – 6 GHz
Power (max. W)	900 CW
Flatness (max.)	± 0.5 dB
Coupling Factor (includes flatness)	60 ± 1.0 dB
Directivity	
typical	18 dB
minimum	15 dB
Insertion Loss (max.)	0.2 dB
VSWR (main line)	1.35:1 max.
Connectors	
main line (J1/J2)	7-16(M)/7-16(F)
coupled (J3/J4)	N(F)/N(F)
Weight (max.)	0.27 kg 0.6 lb.
Size (approx.) W x H x D	54.6 x 50.8 x 34.5 cm (2.15 x 2.0 x 1.36 in.)

DC7276M1 2.5 – 7.5 GHz 2800 W



Frequency Range	2.5 – 7.5 GHz
Power (max. W)	2800 CW
Flatness (max.)	± 2.5 dB
Coupling Factor (includes flatness)	50 ± 3 dB
Directivity	
typical	28 dB
minimum	25 dB
Insertion Loss (max.)	0.3 dB
VSWR (main line)	1.1:1 max.
Connectors	
main line (J1/J2)	WRD-250
coupled (J3/J4)	N(F)/N(F)
Weight (max.)	1.7 kg 3.8 lb.
Size (approx.) W x H x D	45.7 x 8.1 x 8.1 cm (18 x 3.2 x 3.2 in.)

DC7281A 2 – 8 GHz 600 W



Frequency Range	2 – 8 GHz
Power (max. W)	600 CW
Flatness (max.)	± 1 dB
Coupling Factor (includes flatness)	50 dB ± 2 dB
Directivity	
typical	15 dB
minimum	16 dB
Insertion Loss (max.)	0.2 dB max.
VSWR (main line)	1.30:1 max.
Connectors	
main line (J1/J2)	N(M)/N(F)
coupled (J3/J4)	N(F)/N(F)
Weight (max.)	0.25 kg 0.55 lb.
Size (approx.) W x H x D	9.78 x 3.07 x 2.03 cm (3.85 x 120 x 0.80 in.)

DC7351 4 – 8 GHz 6000 W



Frequency Range	4 – 8 GHz
Power (max. W)	6000 CW
Flatness (max.)	± 1.5 dB
Coupling Factor (includes flatness)	40 ± 2 dB
Directivity	
typical	35 dB
minimum	30 dB
Insertion Loss (max.)	0.15 dB
VSWR (main line)	1.1:1 max.
Connectors	
main line (J1/J2)	WRD-350
coupled (J3/J4)	N(F)/N(F)
Weight (max.)	1.24 kg 2.75 lb.
Size (approx.) W x H x D	45.8 x 4.1 x 6.9 cm (18 x 1.61 x 6.9 in.)

DC7435A 4 – 18 GHz 200 W



Frequency Range	4 – 18 GHz
Power (max. W)	200 CW
Flatness (max.)	± 1.5 dB
Coupling Factor (includes flatness)	35 ± 2.5 dB
Directivity	
typical	16 dB
minimum	10 dB
Insertion Loss (max.)	0.6 dB
VSWR (main line)	1.5:1 max.
Connectors	
main line (J1/J2)	N(M)/N(F)
coupled (J3/J4)	SMA(F)/SMA(F)
Weight (max.)	0.1 kg 3 OZ
Size (approx.) W x H x D	4.3 x 1.6 x 1.9 cm (1.7 x 0.625 x 0.75 in.)

DC7445

6 – 18 GHz
3000 W



Frequency Range	6 – 18 GHz
Power (max. W)	3000 CW
Flatness (max.)	± 3 dB
Coupling Factor (includes flatness)	48 dB ± 4 dB
Directivity	
typical	30 dB
minimum	20 dB
Insertion Loss (max.)	0.3 dB max.
VSWR (main line)	1.3:1 max.
Connectors	
main line (J1/J2)	WRD-650
coupled (J3/J4)	N(F)/N(F)
Weight (max.)	0.64 kg 1.4 lb.
Size (approx.) W x H x D	30.5 x 2.9 x 3.5 cm (12 x 1.13 x 1.4 in.)

DC7450M1

7.5 – 18 GHz
3000 W



Frequency Range	7.5 – 18 GHz
Power (max. W)	3000 CW
Flatness (max.)	± 1.5 dB
Coupling Factor (includes flatness)	50 ± 2 dB
Directivity	
typical	28 dB
minimum	25 dB
Insertion Loss (max.)	0.15 dB
VSWR (main line)	1.1:1 max.
Connectors	
main line (J1/J2)	WRD-750 D24
coupled (J3/J4)	N(F)/N(F)
Weight (max.)	0.64 kg 1.42 lb.
Size (approx.) W x H x D	30.5 x 3.5 x 4.4 cm (12 x 1.4 x 1.7 in.)

DC7490

8 – 12 GHz
3000 W



Frequency Range	8 – 12 GHz
Power (max. W)	3000 CW
Flatness (max.)	± 1.5 dB
Coupling Factor (includes flatness)	40 ± 2 dB
Directivity	
typical	40 dB
minimum	35 dB
Insertion Loss (max.)	0.14 dB
VSWR (main line)	1.1:1 max.
Connectors	
main line (J1/J2)	WR90
coupled (J3/J4)	N(F)/N(F)
Weight (max.)	0.45 kg 1 OZ
Size (approx.) W x H x D	33 x 2.54 x 8.43 cm (13 x 1 x 3.32 in.)

DC7462

12 – 18 GHz
1400 W



Frequency Range	12 – 18 GHz
Power (max. W)	1400 CW
Flatness (max.)	± 1.5 dB
Coupling Factor (includes flatness)	40 ± 2 dB
Directivity	
typical	30 dB
minimum	25 dB
Insertion Loss (max.)	0.15 dB
VSWR (main line)	1.1:1 max.
Connectors	
main line (J1/J2)	WR62
coupled (J3/J4)	N(F)/N(F)
Weight (max.)	0.17 kg 0.38 lb.
Size (approx.) W x H x D	28 x 1.8 x 7.6 cm (11 x 0.7 x 3 in.)

DC7530

18 – 26.5 GHz
300 W



DC7620

26.5 – 40 GHz
200 W



DC7820

33 - 50 GHz
200 W



Frequency Range	18 – 26.5 GHz
Power (max. W)	300 CW
Flatness (max.)	± 1 dB
Coupling Factor (includes flatness)	40 dB ± 2 dB
Directivity	
typical	40 dB
minimum	30 dB
Insertion Loss (max.)	0.20 dB max.
VSWR (main line)	1.10:1 max.
Connectors	
main line (J1/J2)	WR42
coupled (J3/J4)	K(F)/K(F)
Weight (max.)	204 g 7.2 oz.
Size (approx.) W x H x D	22.9 x 2.2 x 3.5 cm (9 x 0.88 x 1.4 in.)

Frequency Range	26.5 – 40 GHz
Power (max. W)	200 CW
Flatness (max.)	± 1 dB
Coupling Factor (includes flatness)	40 ± 2 dB
Directivity	
typical	28 dB
minimum	23 dB
Insertion Loss (max.)	0.26 dB max.
VSWR (main line)	1.15:1 max.
Connectors	
main line (J1/J2)	WR28
coupled (J3/J4)	K(F)/K(F)
Weight (max.)	113 g 4 oz.
Size (approx.) W x H x D	14 x 3.5 x 1.9 cm (5.5 x 1.4 x 0.75 in.)

Frequency Range	33 – 50 GHz
Power (max. W)	200 CW
Flatness (max.)	± 1 dB
Coupling Factor (includes flatness)	40 ± 2 dB
Directivity	
typical	32 dB
minimum	30 dB
Insertion Loss (max.)	0.15 dB max.
VSWR (main line)	1.10:1 max.
Connectors	
main line (J1/J2)	WR-22
coupled (J3/J4)	2.4 mm (F) / 2.4 mm (F)
Weight (max.)	453 g 1 lb.
Size (approx.) W x H x D	15.24 x 3.3 x 3.3 cm (6 x 1.3 x 1.3 in.)

LA100



Frequency Range	DC – 18 GHz
Power (max.)	100 W continuous to 25°C
Attenuation	40 dB, ±1.0 dB
Input VSWR (max.)	1.25:1 (DC – 8 GHz) 1.35:1 (8 - 12.4 GHz) 1.45:1 (12.4 - 18 GHz)
Connectors	
Input	N(M)
Output	N(F)
Ambient Temperature Range	–55°C to 125°C
Operating Position	Horizontal Only
Weight (max.)	320 g 11 OZ
Size (approx.) W x H x D	21.8 x 4.2 x 4.2 cm (8.6 x 1.62 x 1.62 in.)

LA150



Frequency Range	DC – 6 GHz
Power (max.)	150 W continuous to 25°C
Attenuation	40 dB, ±1.0 dB
Input VSWR (max.)	1.1:1 (DC – 2 GHz) 1.2:1 (2 – 6 GHz)
Output VSWR (max.)	1.20:1
Connectors	
Input	N(M)
Output	N(F)
Ambient Temperature Range	–55°C to 125°C
Operating Position	Horizontal Only
Weight (max.)	1.13 kg 2.5 lb.
Size (approx.) W x H x D	80 x 80 x 137.1 mm (3.15 x 3.15 x 5.4 in.)

LA500



Frequency Range	DC – 5 GHz
Power (max.)	500 W continuous to 25°C
Attenuation	40 dB, ±1.0 dB
Input VSWR (max.)	1.15:1 (DC – 2.5 GHz) 1.35:1 (2.5 – 5 GHz)
Output VSWR (max.)	1.15:1 (DC – 2.5 GHz) 1.25:1 (2.5 – 5 GHz)
Connectors	
Input	N(M)
Output	N(F)
Ambient Temperature Range	–55°C to 125°C
Operating Position	Horizontal Only
Weight (max.)	3.63 kg 8 lb.
Size (approx.) W x H x D	138.7 x 109.5 x 259.6 mm (5.46 x 4.31 x 10.22 in.)

LA1000



Frequency Range	DC – 3 GHz
Power (max.)	1000 W continuous to 25°C
Attenuation	40 dB, ±1.0 dB
Input VSWR (max.)	1.15:1 (DC – 1.5 GHz) 1.25:1 (1.5 – 3 GHz)
Output VSWR (max.)	1.15:1 (DC – 1.5 GHz) 1.25:1 (1.5 – 3 GHz)
Connectors	
Input	N(M)
Output	N(F)
Ambient Temperature Range	–55°C to 125°C
Operating Position	Horizontal Only
Weight (max.)	13.15 kg 29 lb.
Size (approx.) W x H x D	178 x 332 x 451 mm (70 x 13.1 x 17.76 in.)

FL8200/Kit 5 kHz – 200 MHz



Frequency Range	5 kHz – 200 MHz
Axis Type	Separable X–Y–Z Axis
Field Strength Range (Single Range)	0.3 – 500 V/m
Measurement Type	CW, AM & Pulse
Dynamic Range	> 64 dB
Analog Rise Time (10 – 90% Typical)	300 us
Isotropic Deviation (Measured at Ortho Angle)	±0.5 dB @ 10 MHz
Resolution	< 0.1 dB
CW Damage Level	1000 V/m
Pulse Damage Level	5 kV/m (> 0.1% Duty)
Linearity Error	±0.5 dB or ±0.3 V/m (Whichever is greater)
Temperature Stability (Over Operating Temperature Range)	±0.1 dB (Detection Circuit) ±0.5 dB (Complete System)
Weight	150 g (5.3 oz)
Dimensions (W x H x D)	42.3 x 52.4 x 52.4 mm (1.66 x 26 x 26 in) 29.2 mm (1.15 in) Spherical housing diameter 16.5 mm (0.65 in) Sensor radome height per axis

FL8009/Kit 20 MHz - 9.3 GHz



Frequency Range	20 MHz – 9.3 GHz
Axis Type	Separable X–Y–Z Axis
Field Strength Range (Single Range)	0.5 – 800 V/m
Measurement Type	CW, AM & Pulse
Dynamic Range	> 64 dB
Analog Rise Time (10 – 90% Typical)	300 ns
Isotropic Deviation (Measured at Ortho Angle)	±0.5 dB @ 100 MHz
Resolution	< 0.1 dB
CW Damage Level	1000 V/m
Pulse Damage Level	5 kV/m (> 0.1% Duty)
Linearity Error	±0.5 dB or ±0.3 V/m (Whichever is greater) (±2 dB 20 MHz – 80 MHz)
Temperature Stability (Over Operating Temperature Range)	±0.1 dB (Detection Circuit) ±0.5 dB (Complete System)
Weight	150 g (5.3 oz)
Dimensions (W x H x D)	42.3 x 52.4 x 52.4 mm (1.66 x 26 x 26 in) 29.2 mm (1.15 in) Spherical housing diameter 16.5 mm (0.65 in) Sensor radome height per axis

FL8018/Kit 20 MHz – 18 GHz



Frequency Range	20 MHz – 18 GHz
Axis Type	Separable X–Y–Z Axis
Field Strength Range (Single Range)	2 – 1000 V/m
Measurement Type	CW, AM & Pulse
Dynamic Range	> 54 dB
Analog Rise Time (10 – 90% Typical)	600 – 2400 ns (amplitude dependent)
Isotropic Deviation (Measured at Ortho Angle)	±0.5 dB @ 100 MHz
Resolution	< 0.1 dB
CW Damage Level	1200 V/m
Pulse Damage Level	6 kV/m (> 0.1% Duty)
Linearity Error	±0.5 dB or ±0.5 V/m (whichever is greater)
Temperature Stability (Over Operating Temperature Range)	±0.5 dB
Weight	227 g (8 oz)
Dimensions (W x H x D)	278 x 65 x 65 (10.9 x 2.6 x 2.6 in) 65 mm (2.6 in) Sensor head diameter

FL8040/Kit 20 MHz – 40 GHz



Frequency Range	20 MHz – 40 GHz
Axis Type	Separable X–Y–Z Axis
Field Strength Range (Single Range)	2 – 1000 V/m
Measurement Type	CW, AM & Pulse
Dynamic Range	> 54 dB
Analog Rise Time (10 – 90% Typical)	600 – 2400 ns (amplitude dependent)
Isotropic Deviation (Measured at Ortho Angle)	±0.5 dB @ 100 MHz
Resolution	< 0.1 dB
CW Damage Level	1200 V/m
Pulse Damage Level	6 kV/m (> 0.1% Duty)
Linearity Error	±0.5 dB or ±0.5 V/m (whichever is greater)
Temperature Stability (Over Operating Temperature Range)	±0.5 dB
Weight	227 g (8 oz)
Dimensions (W x H x D)	278 x 65 x 65 (10.9 x 2.6 x 2.6 in) 65 mm (2.6 in) Sensor head diameter

FL8060/Kit 20 MHz – 60 GHz



Frequency Range	20 MHz – 60 GHz
Axis Type	Separable X–Y–Z Axis
Field Strength Range (Single Range)	2 – 1000 V/m
Measurement Type	CW, AM & Pulse
Dynamic Range	> 54 dB
Analog Rise Time (10 – 90% Typical)	600 – 2400 ns (amplitude dependent)
Isotropic Deviation (Measured at Ortho Angle)	±0.5 dB @ 100 MHz
Resolution	< 0.1 dB
CW Damage Level	1200 V/m
Pulse Damage Level	6 kV/m (> 0.1% Duty)
Linearity Error	±0.5 dB or ±0.5 V/m (whichever is greater)
Temperature Stability (Over Operating Temperature Range)	±0.5 dB
Weight	227 g (8 oz)
Dimensions (W x H x D)	278 x 65 x 65 (10.9 x 2.6 x 2.6 in) 65 mm (2.6 in) Sensor head diameter

FM7004A



Inputs:	Up to 4 independent probes, through 4 fiber optic FSMA pairs.
Output:	Graphical, color LCD touch display IEEE-488 (GPIB) USB 2 (test and measurement class) RS-232 Ethernet
Compatible Field Probes	All 7000 and 8000 Series field probes.
Power Requirements:	Input voltage: Universal input 90 – 260 VAC, 50–60 Hz Input current: 0.2 – 0.6 Amps Input type: IEC C14 Inlet with filter Fuse: 1A, 5x20 mm slow blow
Operating Temperature Range:	10°–40°C (50°–104° F) @ 5 – 95% RH noncondensing
Enclosure	Desktop case, 2U high
Correction Factor Tables	Stores up to 6 different tables (each table corresponding to one probe); 2 to 30 frequency points per table
Weight	without enclosure 2.3 kg (5 lb) with enclosure 6.7 kg (14.75 lb)
Size (W x H x D)	without enclosure 48.3 x 9 x 25.4 cm (9 x 3.5 x 10 in) with enclosure 49.8 x 12.7 x 30.5 cm (19.6 x 5 x 12 in)

FI8000



PC Interfaces	IEEE-488 (GPIB) Ethernet, USB 2.0 Test and Measurement Class RS-232 (19200 Baud), Fiber-Optic Serial (19200 Baud)
F/O Connector Type	E-2000 Compact Duplex
Application Software	VM7000, emcware
Laser	Wavelength: 808 nm Maximum Output Power: 2000 mW Class: 1 Shutdown Time: <1 ms After fiber disconnect <250 ms After loss of communication
Power Requirements	Input Voltage: 90 – 260 VAC, 50 – 60 Hz Input Current: 0.2 – 0.6 A Connector Type: IEC C14 Inlet with filter
Ambient Temperature	10° - 40° C
Enclosure	2U Desktop Case with 1U Blank panel installed
Weight	2.3 kg (5 lb) without enclosure 6.8 kg (15 lb) with enclosure
Dimensions (W x H x D)	48.3 x 4.4 x 26.9 cm (19.0 x 1.72 x 10.60 in) without enclosure 50.4 x 11.6 x 30.5 cm (19.84 x 4.58 x 12.0 in) with enclosure

PH2000A 10 kHz – 8 GHz



Frequency Range	10 kHz – 8GHz
Dynamic Range	-60 to +20 dBm
Overload Rating (CW Power)	300 mW
Overload Rating (Peak Power)	1 W for 1 μ S
SWR (max.)	10 kHz - 2 GHz, 1.12:1 2 GHz - 4 GHz, 1.20:1 4 GHz - 8 GHz, 1.40:1
Noise (RMS)	80 pW
RF Input	N(M), 50 ohm

PH2005 500 kHz – 18 GHz



Frequency Range	500 kHz – 8GHz
Dynamic Range	-70 to +20 dBm
Overload Rating (CW Power)	300 mW
Overload Rating (Peak Power)	1 W for 1 μ S
SWR (max.)	500 kHz - 2 GHz, 1.15:1 2 GHz - 6 GHz, 1.20:1 6 GHz - 18 GHz, 1.40:1
Noise (RMS)	30 pW
RF Input	N(M), 50 ohm

PH2010 30 MHz - 40 GHz



Frequency Range	30 kHz – 8GHz
Dynamic Range	-70 to +20 dBm
Overload Rating (CW Power)	300 mW
Overload Rating (Peak Power)	1 W for 1 μ S
SWR (max.)	30 MHz - 4 GHz, 1.25:1 4 GHz - 38 GHz, 1.65:1 38 GHz - 40 GHz, 2.00:1
Noise (RMS)	30 pW
RF Input	K(M), 50 ohm

PM2003 10 kHz - 40 GHz



Frequency Range:	10 kHz – 40 GHz, power head dependent
Power Range:	-70 dBm to +44 dBm, powerhead dependent
Number of Channels	Three (2 simultaneously viewable)
Measurement Speed:	1 channel: 200 Readings/Sec. 2 channels: 100 Readings/Sec.
Dynamic Range:	Up to 90 dB with diode heads, 50 dB with thermocouple heads.
Display Units:	Absolute, watts and dBm. Relative, dBr
Display Resolution:	5 digits, nW, μ W, mW and W; 4 digits dBm
Instrumentation Accuracy:	0.23% of full scale. 0.46% of 1/10 full scale
Inputs:	Rear panel HEAD connectors and rear panel IEEE-488 connector standard.
Outputs	Rear panel PWR/REF connector, 0 dBm, 50 MHz. Rear panel RECORDER BNC connector, 0 to 10 V into 1 M Ω .

PSP102 4 kHz – 6 GHz

Frequency Range:	4 kHz - 6 GHz
Average Dynamic Range:	-60 to +20 dBm
Pulse Dynamic Range:	-45 to +20 dBm
Internal Trigger Range:	-40 to +20 dBm
Risetime (fast/slow)	2 μ s / 1 ms
Overload Rating (CW power)	200 mW
Overload Rating (Peak power)	1 W for 1 μ s
VSWR (max.)	0.01 - 2.0 GHz, 1.15:1 2.0 - 6.0 GHz, 1.20:1
RF Input	N(M), 50 ohm



Sampling Techniques:	Real-time/Equivalent time
Continuous sample rate:	25 MHz
Effective sample rate:	1 GHz
Time resolution:	1 ns
Trigger source:	internal or external TTL
External Trigger in/out:	TTL in (slave) or out (master)
Minimum Trigger Width:	4 μ s
Maximum Trigger Frequency:	120 kHz
Trace Acquisition Speed:	> 30 k sweeps/second
Measurement Speed:	100 k meas/sec (buffered mode) over USB 1000 meas/sec (continuous)
Remote Connectivity:	USB 2, type B connector
Size (LxWxH):	145 x 43 x 43 mm (5.7 x 1.7 x 1.7 in.)
Power Consumption:	2W, (USB high power device)

PSP001 50 MHz – 6 GHz

Frequency Range:	50 MHz - 6 GHz
Average Dynamic Range:	-60 to +20 dBm
Pulse Dynamic Range:	-50 to +20 dBm
Internal Trigger Range:	-38 to +20 dBm
Risetime (fast/slow)	3 ns / <10 μ s
Overload Rating (CW power)	200 mW
Overload Rating (Peak power)	1 W for 1 μ s
VSWR (max.)	0.05 - 6 GHz, 1.25:1
RF Input	N(M), 50 ohm



Sampling Techniques:	Real-time/Equivalent Time/Statistical Sampling
Continuous Sample Rate:	100 MHz
Effective Sample Rate:	10 GHz
Time Resolution:	100 ps
Trigger Sources:	Internal or External TT
External Trigger in/out:	TTL in (slave) or out (master), SMB connector
Minimum Trigger Width:	10 ns
Maximum Trigger Frequency:	50 MHz
Trace Acquisition Speed:	100 K sweeps/second
Measurement Speed:	100 K meas/sec (buffered mode) over USB 800 meas/sec (continuous)
Remote Connectivity:	USB 2, type B connector
Size (LxWxH):	145 x 43 x 43 mm (5.7 x 1.7 x 1.7 in.)
Power Consumption:	2.5W max (USB high power device)

PSP002 50 MHz – 18 GHz

Frequency Range:	50 MHz - 18 GHz
Average Dynamic Range:	-34 to +20 dBm
Pulse Dynamic Range:	-24 to +20 dBm
Internal Trigger Range:	-10 to +20 dBm
Risetime (fast/slow)	5 ns / <10 μs
Overload Rating (CW power)	200 mW
Overload Rating (Peak power)	1 W for 1 μs
VSWR (max.)	0.05 - 2.0 GHz 1.15:1 2.0 - 16 GHz 1.28:1 16 - 18 GHz 1.34:1
RF Input	N(M), 50 ohm



Sampling Techniques:	Real-time/Equivalent Time/Statistical Sampling
Continuous Sample Rate:	100 MHz
Effective Sample Rate:	10 GHz
Time Resolution:	100 ps
Trigger Sources:	Internal or External TT
External Trigger in/out:	TTL in (slave) or out (master), SMB connector
Minimum Trigger Width:	10 ns
Maximum Trigger Frequency:	50 MHz
Trace Acquisition Speed:	100 K sweeps/second
Measurement Speed:	100 K meas/sec (buffered mode) over USB 800 meas/sec (continuous)
Remote Connectivity:	USB 2, type B connector
Size (LxWxH):	145 x 43 x 43 mm (5.7 x 1.7 x 1.7 in.)
Power Consumption:	2.5W max (USB high power device)

PSP004 50 MHz – 18 GHz

Frequency Range:	50 MHz - 18 GHz
Average Dynamic Range:	-50 to +20 dBm
Pulse Dynamic Range:	-40 to +20 dBm
Internal Trigger Range:	-27 to +20 dBm
Risetime (fast/slow)	<100 ns / <10 μs
Overload Rating (CW power)	200 mW
Overload Rating (Peak power)	1 W for 1 μs
VSWR (max.)	0.05 - 2.0 GHz 1.15:1 2.0 - 6 GHz 1.20:1 6.0 - 16 GHz 1.28:1 16 - 18 GHz 1.34:1
RF Input	N(M), 50 ohm



Sampling Techniques:	Real-time/Equivalent Time/Statistical Sampling
Continuous Sample Rate:	100 MHz
Effective Sample Rate:	10 GHz
Time Resolution:	100 ps
Trigger Sources:	Internal or External TT
External Trigger in/out:	TTL in (slave) or out (master), SMB connector
Minimum Trigger Width:	10 ns
Maximum Trigger Frequency:	50 MHz
Trace Acquisition Speed:	100 K sweeps/second
Measurement Speed:	100 K meas/sec (buffered mode) over USB 800 meas/sec (continuous)
Remote Connectivity:	USB 2, type B connector
Size (LxWxH):	145 x 43 x 43 mm (5.7 x 1.7 x 1.7 in.)
Power Consumption:	2.5W max (USB high power device)

PSP003 50 MHz – 40 GHz

Frequency Range:	50 MHz - 40 GHz
Average Dynamic Range:	-34 to +20 dBm
Pulse Dynamic Range:	-24 to +20 dBm
Internal Trigger Range:	-10 to +20 dBm
Risetime (fast/slow)	5 ns / <10 μs
Overload Rating (CW power)	200 mW
Overload Rating (Peak power)	1 W for 1 μs
VSWR (max.)	0.05 - 4.0 GHz, 1.25:1 4.0 - 38 GHz, 1.65:1 38 - 40 GHz, 2.00:1
RF Input	K(M), 50 ohm



Sampling Techniques:	Real-time/Equivalent Time/Statistical Sampling
Continuous Sample Rate:	100 MHz
Effective Sample Rate:	10 GHz
Time Resolution:	100 ps
Trigger Sources:	Internal or External TT
External Trigger in/out:	TTL in (slave) or out (master), SMB connector
Minimum Trigger Width:	10 ns
Maximum Trigger Frequency:	50 MHz
Trace Acquisition Speed:	100 K sweeps/second
Measurement Speed:	100 K meas/sec (buffered mode) over USB 800 meas/sec (continuous)
Remote Connectivity:	USB 2, type B connector
Size (LxWxH):	145 x 43 x 43 mm (5.7 x 1.7 x 1.7 in.)
Power Consumption:	2.5W max (USB high power device)

PSP005 50 MHz – 40 GHz

Frequency Range:	50 MHz - 40 GHz
Average Dynamic Range:	-50 to +20 dBm
Pulse Dynamic Range:	-40 to +20 dBm
Internal Trigger Range:	-27 to +20 dBm
Risetime (fast/slow)	<100 ns / <10 μs
Overload Rating (CW power)	200 mW
Overload Rating (Peak power)	1 W for 1 μs
VSWR (max.)	0.05 - 4.0 GHz, 1.15:1 4.0 - 38 GHz, 1.65:1 38 - 40 GHz, 2.00:1
RF Input	K(M), 50 ohm



Sampling Techniques:	Real-time/Equivalent Time/Statistical Sampling
Continuous Sample Rate:	100 MHz
Effective Sample Rate:	10 GHz
Time Resolution:	100 ps
Trigger Sources:	Internal or External TT
External Trigger in/out:	TTL in (slave) or out (master), SMB connector
Minimum Trigger Width:	10 ns
Maximum Trigger Frequency:	50 MHz
Trace Acquisition Speed:	100 K sweeps/second
Measurement Speed:	100 K meas/sec (buffered mode) over USB 800 meas/sec (continuous)
Remote Connectivity:	USB 2, type B connector
Size (LxWxH):	145 x 43 x 43 mm (5.7 x 1.7 x 1.7 in.)
Power Consumption:	2.5W max (USB high power device)

emcware®

Features

The emcware® Suite by AR RF/Microwave Instrumentation provides automated Electromagnetic Compatibility (EMC) testing and report generation for all types of users from corporate to professional test laboratories. It is a standalone software application designed to operate on a PC running a Microsoft Windows™ operating system. The export classification for this software is EAR99. This software is controlled for export in accordance with the U.S. Export Administration Regulations. Diversion contrary to U.S. law is prohibited.

Software Design

The emcware® Suite is designed to be userfriendly yet extremely flexible. It is broken up into modules based on different types of EMC testing. Within each module there are predefined standards. The ability to create custom test standards is also provided.

Equipment Management

Contained within the emcware® is a built-in Equipment List Manager. This tool allows for equipment to be entered one time and then accessed from within any of the modules. The Equipment List Manager also keeps track of calibration dates and can warn the user when the calibration date of a specific piece of equipment is approaching.

EUT Monitoring

Use custom equipment or a National Instruments DAQ card to monitor and report the status of the equipment under test (EUT). The National Instruments DAQ device can monitor Analog or Digital levels from the EUT or reset the EUT using the Digital Outputs. Custom equipment, in conjunction with dynamic link library (DLL) files, allows for complete EUT monitoring and control.

Instrument Drivers

Instrument control is provided through AR RF/Microwave Instrumentation's extensive driver library. Creation of new drivers for equipment that is not currently supported is available upon request. Drivers can also be created and imported by the user in the form of dynamic link libraries (dll) files. For a list of supported remote interfaces, see the Included Equipment Drivers section.

Signal Routing

The emcware® is designed to allow the user to select between manual and automatic signal routing. Automatic signal routing is implemented using one or more AR RF/Microwave Instrumentation Model SC2000 System Controllers.

Reports

Extensive report generation capability is built into each module. These reports can be customized by the user. All reports are created in Microsoft Word or Microsoft Excel.

Help Instructions

A detailed help utility is included with the emcware®. The contents of the help instructions can be searched by keyword or topic. Open the help file using the context-sensitive help buttons located throughout the user interface.

Licensing

The emcware® is conveniently licensed using a USB hardware dongle that enables full functionality of the software for a single PC. For more details, see the Licensing Information section on Page 4.

AR Systems Compatibility

The emcware® can automatically control select AR Systems using built-in equipment setups. See the Compatible Systems for a complete list.

INCLUDED TEST STANDARDS, emcware®	
Organization	Standard
CISPR	CISPR 11
	CISPR 13
	CISPR 22
	CISPR 25
	CISPR 32
Department of Defense	MIL-STD-461 RS103
	MIL-STD-461 RS103 (Reverb)
	MIL-STD-461 CS114
	MIL-STD-461 RE(101, 102)
	MIL-STD-461 CE (101, 102)
RTCA	DO-160 Section 20
	DO-160 Section 20.6 (Reverb)
	DO-160 Section 21
IEC	61000-4-3
	61000-4-6
	61000-4-21
	50130-4
	60601-1-2
	61000-6-1
	61326
61000-6-2	
Telcordia Technologies	GR-1089-Core
International Organization for Standards	ISO-11452-(2, 3, 5)
	ISO-11452-4
Ford	ES-XW7T-1A278-AC
GM	GMW3097
BMW	GS 95002
Chrysler	DC-11224
Renault	36-00-808
Peugeot	B21 7110



Software Mode: Radiated Susceptibility | Test Option: IEC-61000-4-3 | AR System: None

Active Test Setup: MT DEMO - IEC 61000-4-3 (Level 3) - 612021.rsts

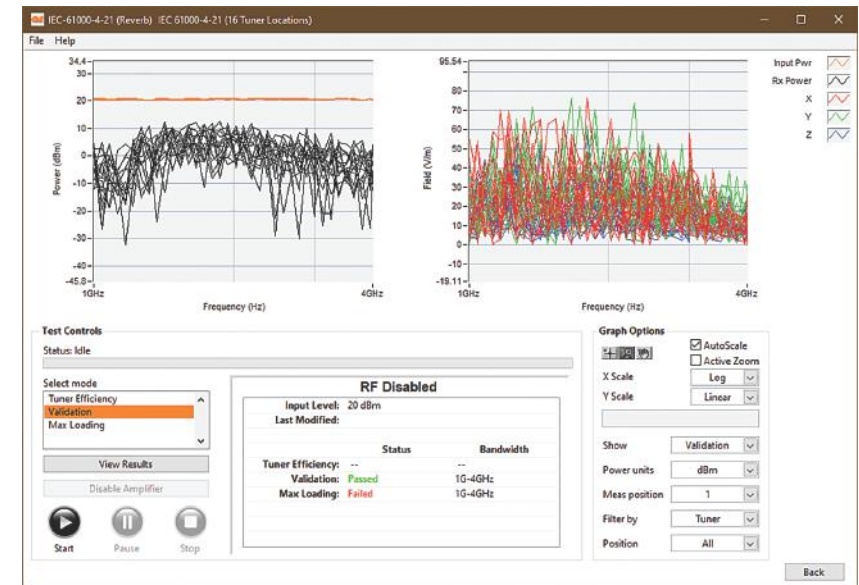
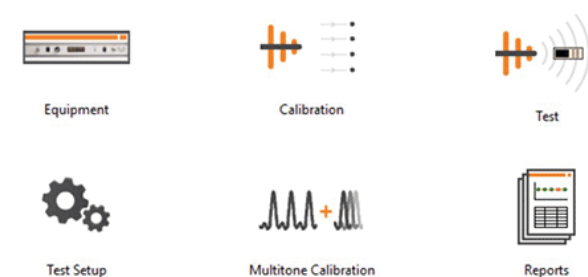

SC Switch Control Platform SC2000, SCX2000 and SCP2000



Rated Voltage	100 – 240 V AC
Rated Frequency	50 – 60 Hz
Rated Power	100 VA max.
Dimensions W x H x D	48.26 x 13.34 x 44.77 cm (19 x 5.25 x 17.625 in)
Weight	
SC2000 (without modules)	approx. 4.1 kg (9 lbs)
SCX2000 (without modules)	approx. 3.9 kg (8.5 lbs)
SCP2000 (with modules)	approx. 6.8 kg (15 lbs)
Module Slots	
Number of module slots	5 on rear of unit
Number of control buses for modules	5
RF Switch Power Handling	See Spec Sheet
Block Diagram	See Spec Sheet

Shielded Enclosure Leak Detector System CL-105A and CL-106A



The CL-105A/CL-106A Shielded Enclosure Leak Detection System (SELDS) provides a convenient means of testing the electromagnetic shielding effectiveness of EMI enclosures by looking at the most likely points of degradation – the seams, doors, and filter connections. The system consists of a Model CL-105A Transmitter, Model CL-106A Receiver, headphones and a rugged carrying case. The incredible sensitivity of the model CL-105A Receiver allows it to meet the most rigid MIL standards (e.g. MIL-STD-188/125) for shielded room acceptance.

This system is designed to make relative shielding effectiveness measurements by passing a current along the surface of an EMI enclosure in order to sense the small magnetic fields formed where breaks in the EMI enclosure may occur.

The Model CL-105A Transmitter is used to generate an output signal which is connected to the EMI enclosure under test. This device has an auto-adjusting output that works with small, medium, and large EMI enclosures. An LED indicator illuminates green when the Transmitter has adjusted the output to the optimum level for the connected EMI enclosure.

The Model CL-106A Receiver has high sensitivity to detect the smallest of magnetic fields produced at breaks in the EMI enclosure under test. This unit auto-zeros and features an auditory output with varying amplitude related to the shielding effectiveness. The auditory output is available through the built-in speaker or included headphones. A 4-digit seven segment display is provided to indicate relative shielding effectiveness measurement values in dB. In addition, a built-in LED light source provides illumination when used in dark environments.

SI1000



Wired Interlock, Remote Out, and Relay Connections

Molex receptacle, 3-pin, 0.093 in. DIA terminals
Mating 3-pin plug connector and terminals supplied

Fiber Optic Connectors (2) FSMA for fiber connection
Compatible with FC2000 Series Cables

Power Requirements

Input Voltage	90–260 VAC, 50–60 Hz
Input Current	0.2–0.6 A
Input type	IEC inlet with filter

Enclosure Rack mount case, 1U high

Dimensions (WxHxD)
48.3 x 4.5 x 17.8 cm (19 x 1.75 x 7 in.)

Weight 2.5 kg (6.25 lb.)

Operating Temperature Range
10°C to 40°C (50°F to 104°F) @ 5% to 95% RH
non-condensing

AR Companies



AR is a multi-national corporation that's made up of a family of companies, each providing innovative solutions and exceptional support and service. These companies include:

AR RF/Microwave Instrumentation

AR RF/Microwave Instrumentation provides Total RF and EMC Test Solutions by offering customers RF test instrumentation, RF test systems, EMC test software, and chambers. In addition to the complete array of product solutions also comes world-class, customer-facing service and applications support.

AR Europe

AR Europe represents AR's deep commitment to the European marketplace. Through a network of partners strategically located throughout Europe, the company supplies systems, antennas, chambers, modules, and power amplifiers for EMC testing and wireless, medical, and industrial applications.

SunAR RF Motion

SunAR RF Motion, manufactures turntables, motorized and manual antenna positioning towers, a system controller, distributed antenna systems (DAS), emission antennas, and reverberation chamber tuners for EMC and wireless testing.

AR Modular RF

AR Modular RF designs and manufactures rack mount and amplifier systems that cover a broad frequency spectrum and offer diverse power ranges. Some of the most innovative, dependable, and durable RF amplifier modules and broadband solid-state RF amplifier systems in the world, these systems are used for communications and medical, scientific, and industrial applications.

With the combined resources of the AR companies, we're able to offer our customers more options, more solutions, and more innovations. In the world of EMC, wireless, and beyond, AR is the one company with infinite solutions.



Your Partner for All Your Equipment Needs

AR Europe is not just a distribution network; we are a system and solution provider!

In collaboration with our third-party sales partners, we supply a broad range of test equipment/ systems for RF/Microwave, EMC, electrical safety, power electronics, test and measurement, and RF shielding applications.

AR Europe is comprised of five AR offices (Ireland, UK, France, Benelux, and Germany) and an extensive network of independent sales representatives' companies. Our network of experienced sales associates and service technicians allows us to provide the best technical solution for our customers' requirements as well as local training, installation, repair, and maintenance support.

With our extensive range of products, services, skills, and experience, AR Europe is the perfect partner for all your test-equipment needs. We have the solutions, from instrumentation to turnkey systems and one-off projects.

A Formidable Force

No one has more experience in all facets of EMC testing equipment than AR Europe and our partners around the world. Working as a team together with our customers, we have the ability to find solutions, solve problems, and provide exceptional service in the most efficient, cost-effective, and timely manner.

With locations throughout Europe, we're nearby and ready to help make EMC testing quicker, easier, and more accurate than ever.

We have developed a very strong customer base in a wide range of electronic/electrical business sectors covering communications, military, commercial, medical, automotive, aerospace, product compliance testing, research, and educational markets.



AR Europe Systems

Your Solution Partner in Europe

AR Europe is not just a distribution network; we are a solution provider. In collaboration with AR RF/Microwave Instrumentation and third-party sales partners, we supply a broad range of test equipment and systems solutions for RF/Microwave applications, EMC, Electrical safety, Power electronics, Test and Measurement, and RF shielding applications.

AR Europe comprises five AR offices (Benelux, France, Germany, Ireland and the UK) and we work with an extensive network of independent sales representatives providing local support across the EMEA region. Our team of experienced sales associates, project engineers and service technicians allows us to provide the best technical solution for our customers' requirements including installation, local training, repair and maintenance support.

With our extensive range of products, services, skills, and experience, AR Europe is the perfect partner for all your test equipment needs. We have the solutions, from instrumentation to full turnkey EMC systems.

AR Europe Systems Through AR/RF Microwave Instrumentation

Our close ties with AR RF/Microwave Instrumentation allow us the ability to offer complete EMC and RF system solutions to an array of customers, requiring systems for military, aerospace, automotive, consumer products, or R&D testing. With an AR system comes the same support and service you have grown accustomed to and trusted throughout the years.

Our Support is as Strong as our Products

Throughout Europe, we have well-equipped service centers staffed by our experienced factory-trained engineers, enabling us to provide high quality local warranty support, repair, and calibration if needed.

With an extensive range of spare parts available in stock we respond quickly, providing a fast turnaround on service helping to minimize your downtime.

Additional services include:

- On-site repair and calibration
- Bespoke service contracts
- Routine maintenance programs
- Management of all your calibration needs (including accredited calibration)
- Shielding effectiveness measurements

Contact your local service centre for more information.



SunAR RF Motion

Manufacturers of Positioning Equipment and Antennas for EMC and Wireless Testing

The SunAR RF Motion product line includes precision positioners for EMC testing, antenna measurements, and OTA testing; antennas for EMC and wireless testing, distributed antenna systems (DAS); turntables; and reverberation system design and stirrers for EMC, shielding effectiveness and OTA testing. Formerly known as SunOI Sciences, the Dublin, CA-based company has built a reputation for providing reliable, high performance and high-quality products; characteristics that make it a perfect fit for AR.

Product Overview

- Full line of standard products
- Scalable designs for specific applications
- Turntables
- Antenna masts / positioners / stands
- Reverberation chamber stirrers
- Antennas
 - EMC and wireless testing
 - Distributed antenna systems (DAS)
- System controllers

Many SunAR products can be customized to your specifications. Call one of our engineers at (925) 833-9936 to learn about customization options for masts, positioners, stirrers, and turntables.

Features

- Advanced, low-maintenance grounding scheme
- Pit ring with self-cleaning ground plane interface (optional square interface)
- Exceeds site attenuation requirements
- Positioning switch located at turntable
- Variable speed standard
- Custom sizes and load ratings available
- All metal construction
- Variety of deck-mounted component options
- Precision—<.0.5° (greater precision optional)
- Manual and remote operation
- Gear driven
- Scan or continuous rotation
- Extremely low maintenance
- Adjustable height
- Fiber-optic interface

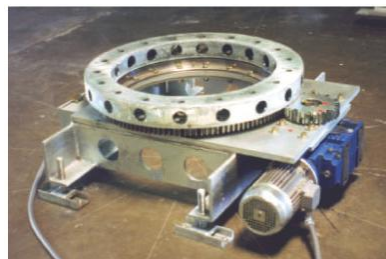

Flush Mount Turntables - Standard Models

Model Number (VS-variable speed)	Diameter, m (ft.)	Distributed Load, kg (lb.)	Caster Load, * kg (lb.)	Min. Pit Depth, mm (in.) **
FM410VS	1.2 (4)	500 (1100)	125 (275)	300 (11.8)
FM1505VS	1.5 (4.9)	500 (1100)	125 (275)	300 (11.8)
FM1511VS	1.5 (4.9)	1000 (2200)	250 (550)	300 (11.8)
FM2005VS	2 (6.6)	1000 (2200)	125 (275)	300 (11.8)
FM2011VS	2 (6.6)	1000 (2200)	250 (550)	300 (11.8)
FM2023VS	2 (6.6)	2000 (4400)	500 (1100)	300 (11.8)
FM2044VS	2 (6.6)	4000 (8800)	1000 (2200)	410 (16)
FM2066VS	2 (6.6)	6000 (13200)	1500 (3300)	410 (16)
FM2522VS	2.5 (8.2)	2000 (4400)	500 (1100)	300 (11.8)
FM2544VS	2.5 (8.2)	4000 (8800)	1000 (2200)	410 (16)
FM3022VS	3 (9.8)	2000 (4400)	500 (1100)	300 (11.8)
FM3044VS	3 (9.8)	4000 (8800)	1000 (2200)	410 (16)
FM3066VS	3 (9.8)	6000 (13200)	1500 (3300)	410 (16)
FM4044VS	4 (13.1)	4000 (8800)	1000 (2200)	460 (18)
FM4066VS	4 (13.1)	6000 (13200)	1500 (3300)	460 (18)
FM5044VS	5 (16.4)	4000 (8800)	1000 (2200)	460 (18)
FM5066VS	5 (16.4)	7000 (15400)	1750 (3850)	460 (18)
FM7066VS	7 (23)	6000 (13200)	1500 (3300)	460 (18)

* Caster Load is defined as the load evenly distributed on four casters, each separated by at least 46 cm (18 in.)

** Low profile models, custom sizes and weight capacities available - consult factory

Surface Mounts



Model	SM46C
Diameter	1.2 m (4 ft.)
Running Load	800 lb.
Table Top Height	2 in. (5 cm)

Model	SM411C
Diameter	1.2 m (4 ft.)
Running Load	1,100 lb.
Table Top Height	3 in. (7.6 cm)

Model	SM2015C
Diameter	2 m
Running Load	1,500 lb.
Table Top Height	3 in. (7.6 cm)

Features

- No pit required
- Indoor/outdoor
- Non-slip drive belt
- Cable access between turntable top and bottom
- Fiber optic interface
- Self-cleaning, fixed rollers
- Non-conductive
- Variable speed standard
- <0.5 degree position accuracy

Free Space FS121



12 in. diameter deck	
Non-conductive deck and riser	
36 in. height (customer specified)	
EUT load rating:	10 lb.
Variable speed:	0-6 rpm
Soft start/stop	
<1° resolution and repeatability	
Low RF cross section	
Portable	
RS-232 control from PC	
Hollow riser tube for cable access	
Simple ASCII command set	
Precision stepper motor drive	
Electromechanical home switch	
120 or 230 VAC, 50-60 Hz	
Options	Fiber-optic interface

Free Space FS241



Diameter: 24 in. (custom diameters available)	
Height at deck: to be specified by customer	(15 in.-96 in.)
Distributed load capacity	~45 kg (100 lb.)
Rotation speed: Variable at 0.5, 1, 2, ~2.2 rpm (custom speeds available)	
Speed may be selected either by pushing a single button on the front panel of the System Controller or by sending a command to the System Controller via the GPIB port (customized control available)	
Position resolution	<0.25°
All material above the motor box is nonconductive	
Cables may be routed between the rotating deck and its base	
Power requirement	115 VAC / 230 VAC, 50/60 Hz, single phase, 4A

TWR99 & TWR95



1 – 2.5 meter (TWR99) and 1 – 4 meter (TWR95) antenna height standard, 1 – 6 meter optional

Electric height adjustment

1 cm height resolution, 0.1m/sec speed

Pneumatic polarization, 0-90°, standard (70-150 PSI CDA required), ¼" NPT male hose needed

Safety brake

Zero maintenance

Total height (2.5 m scan): 116" (~295 cm)

Total height (4 m scan): ~180" (~457 cm)

Absolutely no conductive material above motor box

Strong, stable construction

Fiber optic interface standard (62.5/125 duplex ST)

Easy assembly/disassembly

Maximum antenna load (may require counterweight)

TWR95: 35 lb. (~16 kg)

TWR99: 30 lb. (~14 kg)

120V/230VAC, 50/60Hz, 6A/2x4A

TWR95 base size: 48" x 48" (1.2 m x 1.2 m)

TWR99 base size 30" x 36" (.76 m x .76 m)

Custom sizes and configurations available

TLT2



Automated height, tilt, and polarization

Tower Height 5.5 m (18')

Focal Point Height 4 m or less

Load Capacity 34 kg (75 lbs)

Speed 2, 5, 10 or ~12 cm/s

Height Resolution 1 cm

Height Precision ±0.5 dB

Supply Voltage 120/230 VAC, 50/60 Hz, 4 A

TLT 3



Automated height, tilt, and polarization

Tower Height 4.65 m (15'3")

Focal Point Height 4 m or less

Load Capacity 5.5 kg (12 lbs)

Speed 2, 5, 10 or ~12 cm/s

Height Resolution 1 cm

Height Precision ±0.5 dB

Supply Voltage 120.230 VAC, 50/60 Hz, 4 A

TP1000B



Load Capacity:	27.2 kg (60 lbs)
Maximum Height (Approx.):	137 cm (53.9 in)
Maximum Height With Longer Mast (approximate):	203 cm (80 in)
Minimum Height (Approx.):	89 cm (34.9 in)
Mast Travel:	(24" MAST) 48.3 cm (19 in) (51" MAST) 45.7 cm (18 in) (19" MAST, TP1000BM4) 37.3 cm (14.7 in)
Tilt Angle:	0–90°
Pan Rotation:	360°
Instrument Mounting Screw:	1/4 in. x 20
Material:	PVC, ABS, nylon
Weight:	9.7 kg (20.5 lbs)
Export Classification:	EAR99

TP3000



Load Capacity:	10 kg (22 lb.)
Maximum Height (Approx.):	175 cm (69 in.)
Minimum Height (Approx.):	53 cm (21 in.)
Column Travel:	45 cm (18 in.)
Pan Rotation:	360°
Instrument Mounting Screw:	1/4 in. x 20
Material:	Wood
Weight:	2.6 kg (5.7 lb.)
Export Classification:	EAR99

AP5010B



Load Capacity:	45.36 kg (100 lbs)
Maximum Height (Approx.):	3.31 m (130.25 in)
Minimum Height (Approx.):	2.07 m (81.69 in)
Base Leg:	1.53 m (60.42 in); extends to 2.04 m (80.19 in)
Tilt Angle:	0–30°
Material:	Fiberglass, PVC, Delrin, Nylatron
Weight:	45 kg (98 lbs)
Export Classification:	EAR99

Visit us online to view additional model options and our antenna mounting adapters.

Antenna Positioning Stands APS-1 & APS-1EMP



Model	APS-1
Adjustable leveling casters	
Hard stops at 1, 1.5 and 2 meters	
Fine height adjust	
Adjustable calibration point	
Lightweight	
Disassembles easily	
Exceptionally stable	
Model	APS-1EMP
Adjustable leveling casters	
Hard stops at 1, 1.5 and 2 meters	
Fine height adjust	
Adjustable calibration point	
Remote-controlled polarization	
Lightweight	
Disassembles easily	
Exceptionally stable	

Elevation over Azimuth ELA75



Allows for heavy EUT loads in both elevation (75 lb.) & azimuth (600 lb.)

Variable speed in both elevation & azimuth

Continuous rotation allowed in both elevation & azimuth (with optional components)

Low RF cross-section materials above drive units

Portable (no permanent installation necessary)

Remote azimuth drive option

Height customer-defined

Fiber-optic connections to controller (requires SC104V or SC110V System Controller)

GPIB full control

Custom EUT mounts

Optional RS-232 control

Elevation Positioner EL75



The EL75 provides EUT rotation about a horizontal axis

Allows for heavy EUT loads in elevation (75 lb.)

Variable speed

Continuous rotation allowed in elevation

Materials above drive units

Portable (no permanent installation necessary)

Height customer-defined

Fiber-optic connections to controller (requires SC104V or SC110V System Controller)

GPIB full control

Custom EUT mounts

Optional RS-232 control

Elevation over Azimuth ELA2-2B



Designed for wireless testing of battery powered devices

EUT load rating: 2 lb.

Variable speed: 0-6 rpm

Continuous rotation in both elevation & azimuth

Low RF cross-section

Portable (no permanent installation necessary)

RS-232 control from PC

Fiber-optic interface

Simple ASCII command set

Custom EUT mounts

Precision stepper motor drive

Optional turntable deck with 20 lb. load capacity

System Controllers SC110V



The Model SC110V system controller provides fully independent control of up to three positioning devices and three fully programmable auxiliary devices.

0.01 cm of degree resolution

Variable speed control through front panel or GPIB interface

Fiber optic interface; ST connectors

Rack mount option

115 or 230 volts AC

Compatible with industry standard automation software

Remote upgradeable firmware

Configure Options

Purchase one, two, or three channel units; each has one channel of full device control plus one auxiliary channel.

Visit us online to view additional model options



AR Modular RF

for Tactical Booster Amplifiers, RF Systems and Modules

AR Modular RF designs, manufactures and distributes some of the most innovative, dependable, and durable RF Amplifier Modules and broadband solid-state RF amplifier systems in the world. These products play a critical role in wireless and radio communications, military communications, electronic warfare, electronic countermeasures, homeland security, and have a variety of medical, scientific, and industrial applications.

- RF Amplifier Modules: 0.01 - 6000 MHz, 5 - 500 W.
- Broadband, narrowband and custom designs available
- Military Amplifier Systems and Accessories
- Booster Amplifiers and RF Jammer Amplifiers for tactical military radios from 30 - 512 MHz and from 1.2 - 1.9 GHz
- Power Amplifiers for legacy communication designs as well as virtually every new & emerging communications system



AR-20

30 – 512 MHz
20 W



Power Output	20 CW, 20 WPEP
Frequency Range	30 MHz–512 MHz
Input Power	2W CW or PEP for full 20W output
SATCOM Rx LNA	Built-in
SATCOM Rx LNA Gain/Noise Figure	12 dB/<2.5 dB typical
SATCOM Rx Co-site Filter	Co-Site filter provides >35 dB protection to the SATCOM receive channels
Modulation	All Legacy and Modern complex tactical communications waveforms like ANW2, IW, and SRW
Power Requirements	12–35.5 VDC single XX90 battery or 12 and 28 VDC vehicle supply
Current@24 VDC nominal	<3.2A Amps @ 28 V typical
Operating Temperature	-30 to +60° C Ambient
Water	IP67
Vibration/Shock/Humidity	Designed to meet applicable sections of MIL STD 810/ designed for ground/base vehicle use
Size (HxWxD) Inches	1.58 x 3.75 x 55 in.
Weight	1 lb. 10 oz
JITC Certified	Yes
GSA Schedule	Yes

AR-20KT

30 – 512 MHz
20 W



Power Output	20 CW, 20 WPEP
Frequency Range	30 MHz–512 MHz
Input Power	2W CW or PEP for full 20W output
SATCOM Rx LNA	Built-in
SATCOM Rx LNA Gain/Noise Figure	12 dB/<2.5 dB typical
SATCOM Rx Co-site Filter	Co-Site filter provides >35 dB protection to the SATCOM receive channels
Modulation	All Legacy and Modern complex tactical communications waveforms like ANW2, IW, and SRW
Power Requirements	12–35.5 VDC single XX90 battery or 12 and 28 VDC vehicle supply
Current@24 VDC nominal	<3.2A Amps @ 28 V typical
Operating Temperature	-30 to +60° C Ambient
Water	IP67
Vibration/Shock/Humidity	Designed to meet applicable sections of MIL STD 810/ designed for ground/base vehicle use
Size (HxWxD) Inches	1.58 x 3.75 x 55 in.
Weight	2 lb. 15 oz (Full Kit)
JITC Certified	Yes
GSA Schedule	Yes

AR-20B

30 – 512 MHz
20 W



Power Output	20 CW, 20 WPEP
Frequency Range	30 MHz–512 MHz
Input Power	2W CW or PEP for full 20W output
SATCOM Rx LNA	N/A
SATCOM Rx LNA Gain/Noise Figure	N/A
SATCOM Rx Co-site Filter	N/A
Modulation	All Legacy and Modern complex tactical communications waveforms like ANW2, IW, and SRW
Power Requirements	12–35.5 VDC single XX90 battery or 12 and 28 VDC vehicle supply
Current@24 VDC nominal	<3.2A Amps @ 28 V typical
Operating Temperature	-30 to +60° C Ambient
Water	IP67
Vibration/Shock/Humidity	Designed to meet applicable sections of MIL STD 810/ designed for ground/base vehicle use
Size (HxWxD) Inches	1.58 x 3.75 x 55 in.
Weight	1 lb. 10 oz
JITC Certified	No
GSA Schedule	Yes

AR-20BKT

30 – 512 MHz
20 W



Power Output	20 CW, 20 WPEP
Frequency Range	30 MHz–512 MHz
Input Power	2W CW or PEP for full 20W output
SATCOM Rx LNA	N/A
SATCOM Rx LNA Gain/Noise Figure	N/A
SATCOM Rx Co-site Filter	N/A
Modulation	All Legacy and Modern complex tactical communications waveforms like ANW2, IW, and SRW
Power Requirements	12–35.5 VDC single XX90 battery or 12 and 28 VDC vehicle supply
Current@24 VDC nominal	<3.2A Amps @ 28 V typical
Operating Temperature	-30 to +60° C Ambient
Water	IP67
Vibration/Shock/Humidity	Designed to meet applicable sections of MIL STD 810/ designed for ground/base vehicle use
Size (HxWxD) Inches	1.58 x 3.75 x 55 in.
Weight	2 lb. 15 oz (Full Kit)
JITC Certified	No
GSA Schedule	Yes

AR-20H 30 – 512 MHz 20 W



Power Output	20 CW, 20 WPEP
Frequency Range	30 MHz–512 MHz
Input Power	Nominal 2W–5W CW or PEP for full 20W output
SATCOM Rx LNA	Built-in
SATCOM Rx LNA Gain/Noise Figure	6 dB/4 dB typical
SATCOM Rx Co-site Filter	N/A
Modulation	All Legacy and Modern complex tactical communications waveforms like ANW2C and SRW
Power Requirements	18 to 35.5 VDC compliant to MIL-STD-704F, MIL-STD 461F, MIL-STD 464C
Current@24 VDC nominal	<3.2A Amps @ 24 V typical
Operating Temperature	-40 to +71° C Ambient
Water	IP67
Vibration/Shock/Humidity	MIL-STD-810G
Size (HxWxD) Inches	1.86 x 3.75 x 8.78 in.
Weight	2.6 lb.
JITC Certified	No
GSA Schedule	Yes

AR-20EP 225 – 450 MHz 20 W



Power Output	20 CW, 20 WPEP
Frequency Range	225 MHz – 450 MHz
Input Power	2W CW or PEP for full 20W output
SATCOM Rx LNA	Built-in
SATCOM Rx LNA Gain/Noise Figure	12 dB/4 dB typical
SATCOM Rx Co-site Filter	N/A
Modulation	All Legacy and Modern complex tactical communications waveforms
Power Requirements	12 to 35.5 VDC
Current@24 VDC nominal	<3.2A Amps @ 24 V typical
Operating Temperature	-30 to +60° C Ambient
Water	IP67
Vibration/Shock/Humidity	MIL-STD-81
Size (HxWxD) Inches	1.58 x 3.75 x 5.5 in.
Weight	1 lb. 10 oz
JITC Certified	No
GSA Schedule	Yes

AR-20HC2 300 – 500 MHz 20 W



Power Output	20 CW, 20 WPEP
Frequency Range	300 MHz – 500 MHz
Input Power	Nominal 0.75W–3W CW or PEP for full 20W output
SATCOM Rx LNA	Built-in
SATCOM Rx LNA Gain/Noise Figure	10 dB/2.5 dB typical
SATCOM Rx Co-site Filter	Yes
Modulation	All Legacy and Modern complex tactical communications waveforms like FSK, ANW2C and SRW
Power Requirements	9.5 to 36 VDC
Current@24 VDC nominal	<3.2A Amps @ 28 V typical
Operating Temperature	-40 to +70° C Ambient
Water	IP67
Vibration/Shock/Humidity	MIL-STD-810
Size (HxWxD) Inches	1.86 x 3.75 x 8.78 in.
Weight	2.6 lb.
JITC Certified	No
GSA Schedule	Yes

AR-35 30 – 512 MHz 20 W



Power Output	35 watts CW nominal; 35W PEP with 70% AM modulation
Frequency Range	30 MHz – 512 MHz
Input Power	3W PEP typical for 35W PEP Output
SATCOM Rx LNA	N/A
SATCOM Rx LNA Gain/Noise Figure	N/A
SATCOM Rx Co-site Filter	N/A
Modulation	AM, FM, or PM, and Tactical communications waveforms
Power Requirements	13.8 VDC –33 VDC, from two BAXX90 Batteries or 12 and 24 VDC vehicle systems, filtered and transient protected
Current@24 VDC nominal	5.5 Amps nominal
Operating Temperature	-30 to +60° C
Water	66 ft for 20 min
Vibration/Shock/Humidity	MIL STD 810F/Hand portable
Size (HxWxD) Inches	2.30 x 30 x 7.70 in.
Weight	2 lb.
JITC Certified	No
GSA Schedule	Yes

AR-50

30 – 512 MHz
50 W



Power Output	50 watts CW nominal; 50W PEP with 70% AM modulation; <10% distortion typical
Frequency Range	30 MHz – 512 MHz
Input Power	<5W CW typical for 50W Output
SATCOM Rx LNA	Built-in
SATCOM Rx LNA Gain/Noise Figure	12 dB/2.5 dB typical
SATCOM Rx Co-site Filter	Band pass frequency 239–273 MHz, Out of band rejection >45 dB typical
Modulation	All Legacy and Modern complex tactical communications waveforms like ANW2, WNW, and SRW
Power Requirements	12 – 36 VDC, from Battery or 12 and 24 VDC vehicle systems. Filtered and transient protected
Current@24 VDC nominal	7.5 Amps nominal
Operating Temperature	-30 to +60° C
Water	IP67
Vibration/Shock/Humidity	Per MIL STD 810G (Including SB-X10001B)
Size (HxWxD) Inches	2.50 x 60 x 7.50 in.
Weight	4.4 lb.
JITC Certified	PSC-5D, PRC-117G, PRC-148 JEM
GSA Schedule	Yes

AR-50RC

225 – 450 MHz
50 W



Power Output	LOS: 25 watts CW nominal; 25W PEP with 70% AM modulation; <10% distortion typical SATCOM (290 MHz to 320 MHz): 50 watts
Frequency Range	30 MHz – 512 MHz
Input Power	<5 watts CW typical for 25W LOS and 50W SATCOM Output
SATCOM Rx LNA	Built-in
SATCOM Rx LNA Gain/Noise Figure	12 dB/2 dB typical
SATCOM Rx Co-site Filter	Band pass frequency 239 MHz–273 MHz, Out of band rejection 35 dB typical
Modulation	AM, FM, or PM, and tactical communications waveforms
Power Requirements	12 – 35.5 VDC filtered and transient protected for 12 or 24 volt vehicle systems or dual XX90 batteries
Current@24 VDC nominal	<7.5 Amps @ 24 V typical
Operating Temperature	-30 to +60° C
Water	IP67
Vibration/Shock/Humidity	Per MIL STD 810F
Size (HxWxD) Inches	2.50 x 60 x 7.50 in.
Weight	4.4 lb.
JITC Certified	Based off AR-50 design
GSA Schedule	Yes

AR-50RCS

30 – 90 MHz
50 W



Power Output	50 watts CW nominal; 50W PEP with 70% AM modulation; <10% distortion typical
Frequency Range	30 MHz – 90 MHz
Input Power	<5 watts CW typical for 50 watts Output
SATCOM Rx LNA	N/A
SATCOM Rx LNA Gain/Noise Figure	N/A
SATCOM Rx Co-site Filter	N/A
Modulation	AM, FM, or PM, and tactical communications waveforms
Power Requirements	12 – 35.5 VDC filtered and transient protected for 12 or 24 volt vehicle systems or dual XX90 batteries
Current@24 VDC nominal	<7.5 Amps @ 24 V typical
Operating Temperature	-30 to +60° C
Water	IP67
Vibration/Shock/Humidity	Per MIL STD 810F
Size (HxWxD) Inches	2.50 x 60 x 7.50 in.
Weight	4.4 lb.
JITC Certified	Based off AR-50 design
GSA Schedule	Yes

AR-50S

30 – 88 MHz
50 W



Power Output	50 watts CW nominal; 50W PEP with 80% AM modulation; <10% distortion typical
Frequency Range	30 MHz – 88 MHz
Input Power	<5 watts CW typical for 50 watts Output
SATCOM Rx LNA	N/A
SATCOM Rx LNA Gain/Noise Figure	N/A
SATCOM Rx Co-site Filter	N/A
Modulation	AM, FM, or PM, and Tactical communications waveforms
Power Requirements	12 – 36 VDC filtered and transient protected for 12 or 24 Volt vehicle systems or dual XX90 batteries
Current@24 VDC nominal	<7.5 Amps @ 24 V typical
Operating Temperature	-30 to +60° C
Water	IP67
Vibration/Shock/Humidity	Per MIL STD 810Fe
Size (HxWxD) Inches	2.50 x 60 x 7.50 in.
Weight	4.4 lb.
JITC Certified	Based off AR-50 design
GSA Schedule	Yes

AR-50SE

30 – 88 MHz
50 W



Power Output	50 watts CW nominal; 50W PEP with 80% AM modulation; <10% distortion typical
Frequency Range	30 MHz – 88 MHz
Input Power	<5 watts CW typical for 50 watts Output
SATCOM Rx LNA	N/A
SATCOM Rx LNA Gain/Noise Figure	N/A
SATCOM Rx Co-site Filter	N/A
Modulation	AM, FM, or PM, and Tactical communications waveforms
Power Requirements	12–33 VDC, MIL-STD-461E and 1275
Current@24 VDC nominal	<7.5 Amps @ 24 V typical
Operating Temperature	-40 to +55°C
Water	IP67
Vibration/Shock/Humidity	Per MIL STD 810F
Size (HxWxD) Inches	2.50 x 6.50 x 9.93 in.
Weight	8 lb.
JITC Certified	Based off AR-50 design
GSA Schedule	Yes

AR-55L

1250 – 1800 MHz
20 W



Power Output	45W PEP (+2 dB / -1 dB), typical across the band, with 5W PEP input
Frequency Range	1,250 – 1,800 MHz
Input Power	2–5 W PEP
SATCOM Rx LNA	Built-in
SATCOM Rx LNA Gain/Noise Figure	12 dB/<3.5 dB typical
SATCOM Rx Co-site Filter	High pass Filter, Out of band rejection 40 dB typical
Modulation	Constant Envelope Waveforms
Power Requirements	28 VDC filtered and transient protected
Current@24 VDC nominal	7 Amps @ 28 V typical
Operating Temperature	-30 to +60° C Ambient
Water	IP67
Vibration/Shock/Humidity	Designed to meet applicable sections of MIL STD 810F/Designed for ground/base vehicle use
Size (HxWxD) Inches	2.5 x 6 x 7.5 in.
Weight	6 lb.
JITC Certified	No
GSA Schedule	Yes

AR-75

30 – 512 MHz
75 W



Power Output	75 watts CW nominal; 75 W PEP with 70% AM modulation; <10% distortion typical
Frequency Range	300 MHz – 512 MHz
Input Power	5–8 watts CW typical for nominal 75 watts Output
SATCOM Rx LNA	Built-in
SATCOM Rx LNA Gain/Noise Figure	12 dB/2 dB typical
SATCOM Rx Co-site Filter	Band pass frequency 239–273 MHz, Out of band rejection 45 dB typical
Modulation	AM, FM, or PM, and Tactical communications waveforms
Power Requirements	18–35.5 VDC filtered and ransient protected for 24 volt vehicle systems batteries MIL-STD 1275 and 461 compliant DC-DC internal power supply
Current@24 VDC nominal	<9.5 Amps @ 24 V typical
Operating Temperature	-40 to +70° C Ambient
Water	IP67
Vibration/Shock/Humidity	Per MIL STD 810F
Size (HxWxD) Inches	30 x 60 x 11.17 in.
Weight	10.5 lb.
JITC Certified	No
GSA Schedule	Yes

AR-75-M50

30 – 512 MHz
50 W



Power Output	Nominal 50 watts CW; 50W PEP 70% DOM; <10% distortion <5% typical
Frequency Range	30 MHz – 512 MHz
Input Power	~5–7 watts CW typical for 50 watts Output
SATCOM Rx LNA	Built-in
SATCOM Rx LNA Gain/Noise Figure	12 dB/2 dB typical
SATCOM Rx Co-site Filter	Band pass frequency 239 MHz–273 MHz, Out of band rejection 45 dB typical
Modulation	AM, FM, or PM, and modern Tactical networking communication waveforms
Power Requirements	18–35.5 VDC filtered and transient protected for 24 volt vehicle systems batteries; MIL-STD 1275 and 461 compliant DC-DC internal power supply filter
Current@24 VDC nominal	< 9.5 Amps @ 24 V typical
Operating Temperature	-30 to +60° C
Water	IP67
Vibration/Shock/Humidity	Per MIL STD 810F
Size (HxWxD) Inches	30 x 60 x 11.17 in.
Weight	10.5 lb.
JITC Certified	No
GSA Schedule	Yes

AR-125R 30 – 512 MHz 125 W



Power Output	125 watts CW typical
Frequency Range	30 MHz – 512 MHz
Input Power	10 watts typical, up to 20W without damage
SATCOM Rx LNA	External/KMW2030P
SATCOM Rx LNA Gain/Noise Figure	12 dB/2 dB typical
SATCOM Rx Co-site Filter	N/A
Modulation	AM/FM/PM, SINCGARS, HPW, HAVEQUICK, DAMA, IW, SRW and ANW2, plus others
Power Requirements	AC power: 100-240 VAC, 50-60 Hz DC power: 18-36 VDC (approx. 650 watts @ 24 VDC)
Current@24 VDC nominal	27 Amps typical
Operating Temperature	-30 to +60° C (ambient)
Water	No
Vibration/Shock/Humidity	Per MIL-STD-461
Size (HxWxD) Inches	3.5 x 19 x 24 in.
Weight	~ 25 lb.
JITC Certified	No
GSA Schedule	Yes

AR-5010

30 MHz - 88 MHz
500 W CW/PEP



Basic Communications

Lightweight, 19-in., 2U rack mount

Ethernet remote control

AR-5000

80 kHz - 1 GHz
100 - 500 W CW
1000 W peak



Base Platform for Quick Customizations

Class A or Class AB

Lightweight 19-in., 2U rack mount

Ethernet remote control

Subsystems for Integration



Custom packaging

Engineered to customer specifications

Sub-octave and multi-octave designs

Physics Applications



Custom frequency band

Highly repeatable performance unit to unit

Multiple calibrated monitoring ports

Highly reliable for long-term 24/7 use

AR-5030/AR-5030C2

700 MHz - 960 MHz
80 W CW/PEP



Shipboard Communications

Lightweight, 19-in., 2U Rack Mount

Ethernet remote control

Modules for OEMs and Integration

10 kHz - 6 GHz



High- and low-gain power amplifier modules

Mini-system PA modules with ALC and interfaces

Communication Systems

Up to 1000 W output



VHF/UHF band operation

24/7 operation capable

Repeatable performance unit to unit for field interchangeability

Single-phase and three-phase AC power capable from same unit

Rack Mount Amplifiers		
Model	Frequency Response	Maximum Output Power (W)
KAA1020	10 kHz - 230 MHz	25
KAW1080	10 kHz - 1000 MHz	25
KAA5170P	500 kHz - 5.5 MHz	1000 Pulse
KAA2030	500 kHz - 40 MHz	200
KAA2020	500 kHz - 100 MHz	100
KAW1020	500 kHz - 1000 MHz	5
KAA4020	1 - 50 MHz	500
KAA4021P	1 - 50 MHz	300 Pulse
KAW1050	1 - 400 MHz	25
KAW1040	1 - 512 MHz	20
KAA3020	2 - 32 MHz	100
AR-5010	30 - 88 MHz	500
KAA2070-M11	70 - 76 MHz	300
AR-5000	80 - 1000 MHz (Call factory for details)	100 - 500
KAW5030	100 - 400 MHz	200
KAW2040	100 - 500 MHz	100
KAW2300	100 - 1000 MHz	100
KAW2020	200 - 500 MHz	100
KAW2100-M2	200 - 500 MHz	200
KAW2020-M16	220 - 245 MHz	100
KAW5050	225 - 400 MHz	1000 PEP, 500 CW
KAW4040-M12	390 - 410 MHz	500
KAA2030-M11	500 kHz	300
AR-5030	700 - 960 MHz	80
AR-5030C2	700 - 960 MHz	80
KAA2026	700 kHz - 3 MHz	125

Amplifier Modules		
Model	Frequency Response	Maximum Output Power (W)
KMA2020	10 kHz - 230 MHz	100
KMA2040-M25	100 kHz - 50 MHz	100-500
KMA1040	200 kHz - 50 MHz	50
KMA2040	500 kHz - 40 MHz	200
KMA2040-M12	500 kHz - 40 MHz	200
KMA2040P	500 kHz - 40 MHz	200 (CW)
KMW1020	500 kHz - 512 MHz	10
KMW1060	1 - 512 MHz	20
KMA2040-M22	2 - 30 MHz	200 CW, 250 Peak
KMA4040	30 - 40 MHz	400
KMW2026-M5	30 - 512 MHz	30
KMW2026-M20	30 - 512 MHz	100-200
KMW2025	30 - 512 MHz	100-200 CW, 500 Pulse
KMA1001	225 - 400 MHz	1
KMW2040-M17	225 - 400 MHz	100
KMW2040-LTE	225 - 400 MHz	100 CW, 125 Peak
KMW2026-M15	225 - 450 MHz	40
KMW2026-M26	291 MHz	60

Contact Sales

Our Worldwide Sales and Support Network.

Visit our website at www.arworld.us to find the sales associate in your territory.

AR US Sales Associates

- | | | |
|---|---|--|
| <p>1. ProTEQ Solutions
Nashua, NH
888-490-6624</p> <p>2. Advanced Technical Marketing
Parsippany, NJ
800-310-8805</p> <p>3. Delmarva Engineering
Crownsville, MD
410-990-9000</p> <p>Charlottesville, VA
410-990-9000</p> <p>4. EQS Systems, LLC
Chesterland, OH
800-729-8084</p> <p>5. Brennan Associates
Saint Petersburg, FL
727-446-5006</p> <p>Delray Beach, FL
727-446-5006</p> <p>Seffner, FL
727-446-5006</p> <p>6. DyTec/Midwest Inc.
Rolling Meadows, IL
847-255-3200</p> | <p>7. Testech Sales Engineers
Richardson, TX
972-644-5010</p> <p>Austin, TX
972-644-5010</p> <p>Houston, TX
972-644-5010</p> <p>Edmond, OK
972-644-5010</p> <p>8. Technical Marketing Specialists
Greenwood Village, CO
800-342-8408</p> <p>Tempe, AZ
800-342-8408</p> <p>Albuquerque, NM
800-342-8408</p> <p>Salt Lake City, UT
800-342-8408</p> | <p>9. PSI Solutions Inc.
Tacoma, WA
OR, SW WA, ID, and MT
253-838-9263</p> <p>WA, Alaska
253-838-9263</p> <p>10. Ward/Davis Associates
San Jose, CA
408-213-1090</p> <p>Redondo Beach, CA
310-643-6977</p> <p>San Diego, CA
310-643-6977</p> <p>11. ACA Tmetrix Inc.
Mississauga, ON Canada
800-665-7301</p> <p>12. Sistemas e Ingeniería de EMC (SIEMC)
Colonia Cuajimalpa
Mexico City (Mexico)
+52 (55) 2163 2148
+52 (55) 2163 2979</p> |
|---|---|--|



AR International Sales Associates

- | | | | |
|---|---|--|---|
| <p>Albania
AR Europe
+353 61 50 4300</p> <p>Argentina
Instrumental Tech
+54 911 33954300</p> <p>Australia
Scientific Devices
+61 3 9569 1366</p> <p>Austria
AR Deutschland GmbH
+49 6101 802700</p> <p>Bahrain
Motabaqah
Trading Company
+966 11 4160110</p> <p>Belarus
Radiant-Elcom
+7495 725 0404</p> <p>Belgium
AR Benelux B.V.
+31 1724 23000</p> <p>Brazil
Boreal Communications
+55 (19) 3258-2210</p> <p>Bulgaria
Test Solutions
+359 2 970 19 90</p> <p>Canada (Except BC)
Tmetrix
(905) 502 2005</p> <p>Canada, British Columbia
ACA Tmetrix Inc.
800-665-7301</p> <p>Central America
SIEMC
+52 (55) 2163 2148
+52 55 2163 2979</p> <p>Chile
Boreal Communications
+55 (19) 3258-2210</p> <p>China
Yifeng Tech
+86 10 6788 6078</p> <p>Croatia
AR Europe
+353 61 50 4300</p> <p>Cyprus
Vector Technologies Ltd
+30 210 6858008</p> <p>Czech Republic
Tectra
+420 281921650</p> <p>Denmark
Altoo Measurement Science ApS
+45 30 38 23 82</p> | <p>Egypt
SHIMCO
Engineering Consultants
+20 122 213 9410</p> <p>Estonia
Testhouse Finland
+358 40 544 8283</p> <p>Finland
Testhouse Finland
+358 40 544 8283</p> <p>France
AR France SAS
+33 1479 175 30</p> <p>Germany
AR Deutschland GmbH
+49 6101 802700</p> <p>Greece
Vector Technologies Ltd
+30 210 6858008</p> <p>Greenland
Altoo Measurement Science
ApS
+45 30 38 23 82</p> <p>Hungary
Tectra
+36 12970485</p> <p>Iceland
Altoo Measurement Science ApS
+45 30 38 23 82</p> <p>India
Complus Systems Pvt Ltd
+91 (80) 41683883</p> <p>Indonesia
Precision Technologies
PTE, Ltd. Singapore
+ 65 6 2734573</p> <p>Ireland
OTC
+353 8722 89801</p> <p>Israel
MTI Summit Electronics
+972 3 9008900
+972 54 3181903</p> <p>Italy
DELO Instruments
+39 029 072 2441</p> <p>Japan
Nippon Automatic
Control Company
+81 3 5434 1600</p> <p>Korea (South)
EMC Solutions, Inc.
+82 70 7805 5100</p> <p>Kuwait
Motabaqah
Trading Company
+971 2 6222 341</p> <p>Latvia
SIA "SKAILOKS"
+371 26599887</p> | <p>Lithuania
UAB "LOKMIS"
+370 5215 1895</p> <p>Luxembourg
AR Benelux B.V.
+31 1724 23000</p> <p>Malaysia
Precision Technologies
PTE, Ltd. Singapore
+ 65 6 2734573</p> <p>Macedonia
Test Solutions
+359 2 970 19 90</p> <p>Montenegro
Test Solutions
+359 2 970 19 90</p> <p>Mexico
SIEMC
+52 55 2163 2148
+52 55 2163 2979</p> <p>Malta
DELO Instruments
+39 029 072 2441</p> <p>Moldova
Lokmera
+373 22 92 02 33</p> <p>Montenegro
Test Solutions
+359 2 970 19 90</p> <p>Netherlands
AR Benelux B.V.
+31 1724 23000</p> <p>New Zealand
Scientific Devices
+61 3 9569 1366</p> <p>Norway
4Test AS
+47 40 28 09 94</p> <p>Oman
Motabaqah
Trading Company
+971 2 6222 341</p> <p>Pakistan
TELEC Electronics &
Machinery Ltd.
+92 (21) 5217201</p> <p>Philippines
Precision Technologies
PTE, Ltd. Singapore
+ 65 6 2734573</p> <p>Poland
ASTAT sp. z o.o.
+48 61 435 95 12</p> <p>Portugal
INVCOM
+34 976 013 300</p> <p>Romania
COMTEST SRL
+402 1211 0883</p> | <p>Russia
Radiant-Elcom
+7495 725 0404</p> <p>Saudi Arabia
Motabaqah
Trading Company
+966 11 4160110</p> <p>Serbia
Test Solutions
+359 2 970 19 90</p> <p>Singapore
Precision Technologies
PTE, Ltd. Singapore
+ 65 6 2734573</p> <p>Slovakia
Tectra
+420 281921650</p> <p>Slovenia
AR Europe
+353 61 50 4300</p> <p>South Africa
Prolea Electronics Pty Ltd
+27 117195791</p> <p>South America
Boreal Communications
+55 (19) 3258 2210</p> <p>Spain
INVCOM
+34 976 013300</p> <p>Sweden
Precision Sweden
+46 706 293661</p> <p>Switzerland
Emitec Messtechnik AG
+41 417486010</p> <p>Taiwan
Evergo Microwave Inc.
+886 2 2601 9679</p> <p>Thailand
Precision Technologies
PTE, Ltd. Singapore
+ 65 6 2734573</p> <p>Turkey
ORKO Mumessillik
+90 3124382213</p> <p>Ukraine
AR Europe
+353 61 50 4300</p> <p>United Arab Emirates
Motabaqah
Trading Company
+971 2 6222 341</p> <p>United Kingdom
AR United Kingdom Ltd.
+44 1908 282 766</p> <p>Vietnam
Precision Technologies
PTE, Ltd. Singapore
+ 65 6 2734573</p> |
|---|---|--|---|



Contact Service

We believe local after sales support and service are essential, and we strive to provide the best service possible.

Our highly trained technicians maintain equipment so that even older or rebuilt AR products continue to perform the same as they did on Day 1. There are rebuilt AR amplifiers over 20 years old that are still going strong and delivering precision results.

You can depend on AR's service from calibration and regular maintenance to troubleshooting and repairs.

Three-Year, No Questions Asked Warranty

We set a new standard when introducing our three-year warranty (one-year warranty for TWTs and powerheads). It's easy to stand behind your products when their quality is unsurpassed. Making sure that AR products exceed your expectations is our goal. We do whatever it takes to achieve that.

In the US, contact AR's Customer Service Department at 215.723.0275 or service@arworld.us. Outside of the US, contact the AR distributor nearest you. (Maybe reference previous page?)

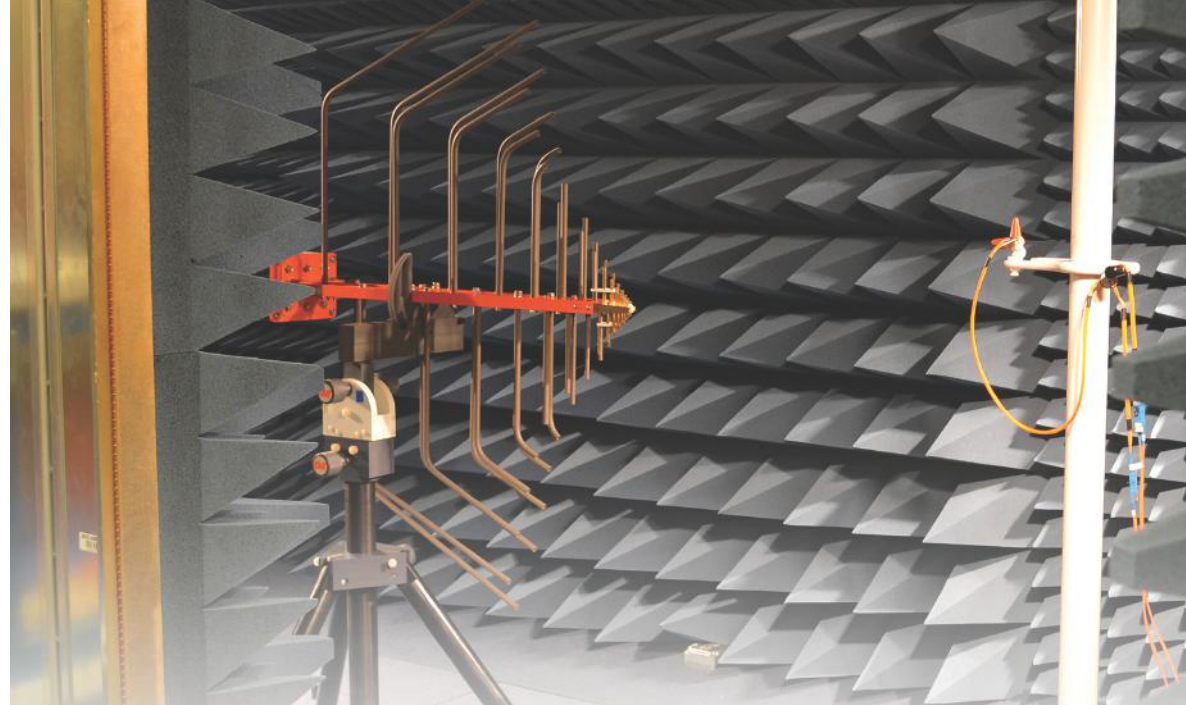

	Basic Warranty	Assured	Enhanced	Performance
Technical Support (HW and SW)				
Email / Phone Case Response Time	24 hrs.	8 hrs	4 hrs	2 hrs
24 x 5 Technical Support				✓
On-Site Post-Sales Support				✓
Hardware Support				
Repair Service Coverage Turnaround Time	15 business days	14 business days	10 business days	7 business days
Calibration Service Turnaround Time	15 business days	10 business days	5 business days	3 business days
Firmware Release and Updates	✓	✓	✓	✓
Spare Parts/Consignment Inventory			optional	✓
Product Maintenance	optional	optional	optional	optional
Software Support				
Updates and Maintenance Releases	✓	✓	✓	✓
Proactive Release Notification	✓	✓	✓	✓
Success Services				
Customer Success Manager—Advocate, Escalation Point			✓	✓
Onboarding and Support Performance Metrics Report		✓ Annual	✓ Bi-Annual	✓ Quarterly

1. Response time based on AR standard business hours and hardware support turnaround time excludes component lead time.
2. AR Software Agreement required for software support.
3. All the offered services are subject to availability of capabilities in country and legal terms and conditions.
4. Contact your local AR sales representative for more information.



AR's Competitive Edge

At AR, there's no substitute for customer responsiveness. It's the foundation of our business and the AR value that's recognized around the globe. It's one of the key reasons AR has become the worldwide leader in EMC, wireless and beyond.

AR products do more, last longer, work harder, and make your job easier. And that gives you a fierce competitive edge. Only AR delivers innovative technology, advanced design, quality build and workmanship, mismatch capability, durability and longevity, less cost per watt, and a worldwide support network that's here for you today and tomorrow. With the combined resources of all the AR companies, we simply have more of the best people making the products to overcome your toughest challenges.

AR RF/Microwave Instrumentation

- RF & Microwave Solid State Amplifiers ranging from: 1-50000 watts, 10 Hz - 50 GHz
- Antennas to 15000 watts input power, 10 kHz - 50 GHz
- EMC and Wireless Test Systems
- Multi-tone test systems
- Field measuring equipment
- EMC test software
- EMC & RF test accessories
- Positioning equipment
- Chambers and accessories

Connect with us!



facebook.com/ARRFMicrowave



linkedin.com/company/ar-rf-microwave-instrumentation

AR Modular RF

- Tactical Booster RF Amplifiers for Military Radios
- RF Amplifiers and Modules for Industrial, Medical, Scientific and Communication Applications
- RF Rack Mount Amplifiers for Industrial, Medical, Scientific and Communication Applications

SunAR RF Motion

- Positioning equipment, turntables and towers
- Distributed antenna systems
- Reverberation chamber stirrers
- EMC Test Antennas

AR Europe

- Offering a complete line of RF Products and

AR RF/Microwave Instrumentation

160 Schoolhouse Road
Souderton, PA 18964, USA
Tel 215-723-8181

AR Modular RF

21222 30th Dr. SE, Building C, Suite 200
Bothell, WA 98021, USA
Tel 425-485-9000 • Fax 425-486-9657

SunAR RF Motion

6780 Sierra Court, Suite R
Dublin, CA 94568, USA
Tel 925-833-9936 • Fax 925-833-9059

AR Europe

National Technology Park, Ashling Building
Limerick, Ireland V94 W9FP
+353 61 504300 • Fax +353 61 504301
AR Benelux +31 172 423000
AR France +33 147 917530
AR Deutschland GmbH +49 6101 80270 0
AR United Kingdom +44 1908 282766

AR RF/Microwave Instrumentation is ISO Certified.

Want to know more about AR? Need help with any RF solutions or testing procedures?



Here's how to reach AR and get all the help you need:

www.arworld.us

AR Global Promise

The AR warranty is more than just a warranty, it's a promise, backed by a knowledgeable support team that's always there for you to help solve any problems and answer any questions, today and tomorrow. AR warrants its amplifiers, antennas, test systems, power meters, field monitoring equipment, conducted immunity generators, couplers and tripods to be free of defects in materials and workmanship for a period of three years from date of shipment. Vacuum, traveling wave tubes and powerheads carry a one year warranty.

