

IEC 60601-1-2 ED. 4.1 / IEC 61000-4-39

New requirement, immunity to proximity magnetic fields based on IEC 61000-4-39

Equipment designed for the task



The IEC 60601-1-2 standard is the international standard for testing medical equipment to EMC. The latest update adds a new test as more transmitter products are present in homes, offices (locations where medical equipment may be used), and hospitals. Three frequencies that are in use are: 30 kHz, 134.2 kHz, and 13.56 MHz. The standard IEC 61000-4-39 for testing fields in close proximity is referenced for this testing. With our IEC 60601-1-2 setup these test fields can be produced.

Requirements: IEC 60601-1-2

Test Frequency	30 kHz	134,2 kHz	13,56 MHz
Modulation	Continuous wave	Pulse modulation 2,1 kHz	Pulse modulation 50 kHz
Immunity Test Level (A/m)	8	65	7,5

Requirements: IEC 61000-4-39

Frequency range	9 kHz to 150 kHz	150 kHz to 26 MHz
Level	Test field strength (A/m)	Test field strength (A/m)
1	1	0,1
2	3	0,3
3	10	1
4	30	3
X	Special	Special
Modulation	Amplitude modulation	Pulse modulation
Frequency	1 kHz	2 Hz, 1 kHz
Parameter	80%	50% duty cycle



IEC 60601-1-2 ED. 4.1 / IEC 61000-4-39

New requirement, immunity to proximity magnetic fields based on IEC 61000-4-39

The magnetic loops are specified in IEC 61000-4-39 and are readily available. However, producing a field through the loops might not be straight forward. The loop impedance changes over its frequency range, and the amplifier being used will not match this impedance. The result would be a much higher power requirement. In this case, we are not covering a frequency range but individual frequency points. This allows a matching network to be created to match the loop to the amplifier's impedance.

Basic Setup

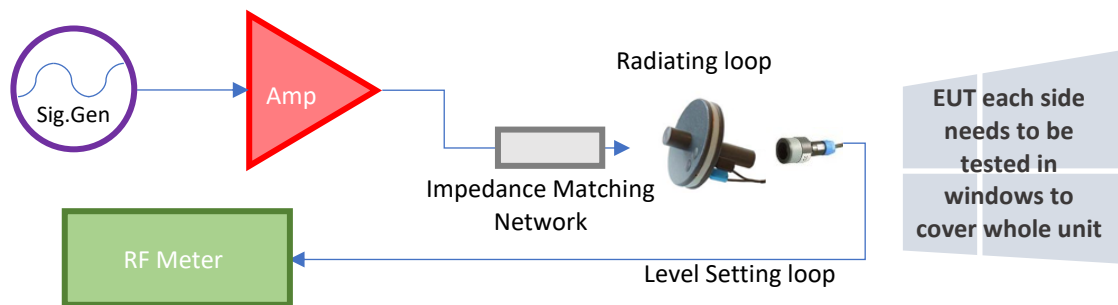

Schlöder has created a system to match this requirement. The system is computer-controlled to set the field level and perform testing with report generation.

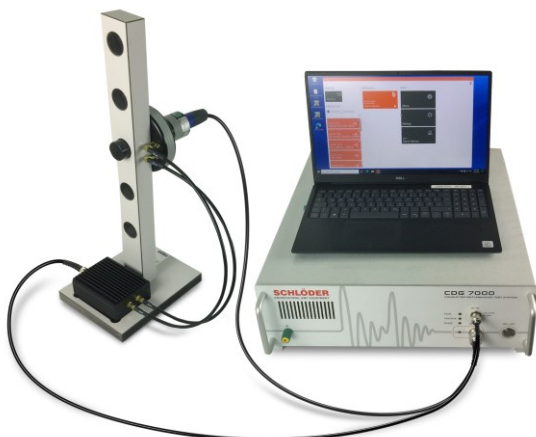
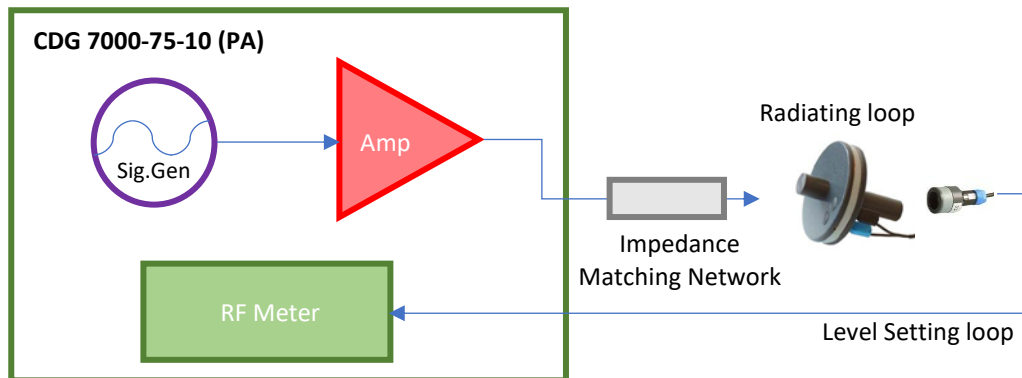

In combination with the CDG 7000-75-10 (PA) and a complete set for the corresponding frequency range, international standards (IEC 60601-1-2 ED. 4.1 / IEC 61000-4-39) for testing medical devices for electromagnetic compatibility can be carried out. These complete sets include a radiating loop, a loop sensor, the matching network for the impedance and a corresponding stand for the loops.



IEC 60601-1-2 ED. 4.1 / IEC 61000-4-39

New requirement, immunity to proximity magnetic fields based on IEC 61000-4-39

EN 61000-4-39 describes magnetic field tests in the near field in two frequency ranges from 9 kHz - 150 kHz and from 150 kHz - 26 MHz. For both ranges, complete sets are offered for operation on a typical RF broadband amplifier. *(Take the required sets for your tests from the "Equipment or complete sets.." compilation).*

Frequency range 9 kHz – 150 kHz	Frequency range 150 kHz – 26 MHz
<p>IEC 61000-4-39</p> <p>RL 120 transmitting coil with LS 040 loop sensor (electrostatic shielded) from MIL-STD-461:</p> <ul style="list-style-type: none"> ▪ Field strengths 1 ... 30 A/m ▪ Modulation AM 80% 1 kHz sine ▪ Illumination area 100 x 100 mm ▪ Distance 50 ±3 mm ▪ Test frame with coil mounting holes on 150, 250, 350, 450 mm. ▪ Matching network with 2x10 Ω series resistors for matching to RF amplifiers at low frequencies ▪ Power consumption < 46 dBm (just under 40 W) at 150 kHz and 30 A/m incl. modulation 	<p>IEC 61000-4-39</p> <p>For the upper frequency range, the 61000-4-39 defines a new 100 mm transmitting coil with 3 turns. The generated field is measured with a loop sensor, also newly defined, with a diameter of 40 mm and only 1 turn. In the standard, only the loop sensor is electrostatically shielded. To prevent the radiation of an electric field at higher frequencies, the RL 100-3 is also electrostatically shielded and symmetrically controlled via a balun:</p> <ul style="list-style-type: none"> ▪ Field strengths 0.1 ... 3 A/m: A preamplifier (PA) is required to measure this low field strength! ▪ Pulse modulation with 50% duty cycle and 2 Hz or 1 kHz modulation frequency ▪ Illumination area 80 x 80 mm ▪ Test frame with coil mounting holes on 120, 200, 280, 360, 440 mm ▪ Matching network with balun for balanced drive and 2 x 10 Ω series resistors for matching to RF amplifiers at low frequencies ▪ Power consumption < 44 dBm (appr. 25 W) at 26 MHz and 3 A/m
<p>IEC 60601-1-2</p> <p>In 60601-1-2, magnetic field tests are required with RL 120, but only at two defined frequencies with modified levels and modulations:</p> <ul style="list-style-type: none"> ▪ 30 kHz with 8 A/m continuous wave ▪ 134.2 kHz with 65 A/m, 2.1 kHz pulse-modulated <p>The required power here is max. 46.3 dBm (approx. 43 W).</p> <p>To reduce the power to approx. 43.1 dBm (approx. 20 W), an optional resonant capacitor can be connected in series.</p>	<p>IEC 60601-1-2</p> <p>In 60601-1-2, magnetic field tests are required with RL 100, but only at 13.56 MHz. Level and modulation have also been changed here.</p> <ul style="list-style-type: none"> ▪ 13.56 MHz with 7.5 A/m, 100 kHz pulse modulation <p>Without resonant network, more than 49.3 dBm (approx. 85 W) is required. With resonant network, the power requirement is reduced to about 35 dBm (approx. 3.2 W).</p> <p>Thus, 30 A/m can be achieved for a short time with about 50 W amplifier power.</p> <p>VSWR is < 1:2 in resonance.</p>



IEC 60601-1-2 ED. 4.1 / IEC 61000-4-39

New requirement, immunity to proximity magnetic fields based on IEC 61000-4-39

Construction coil set

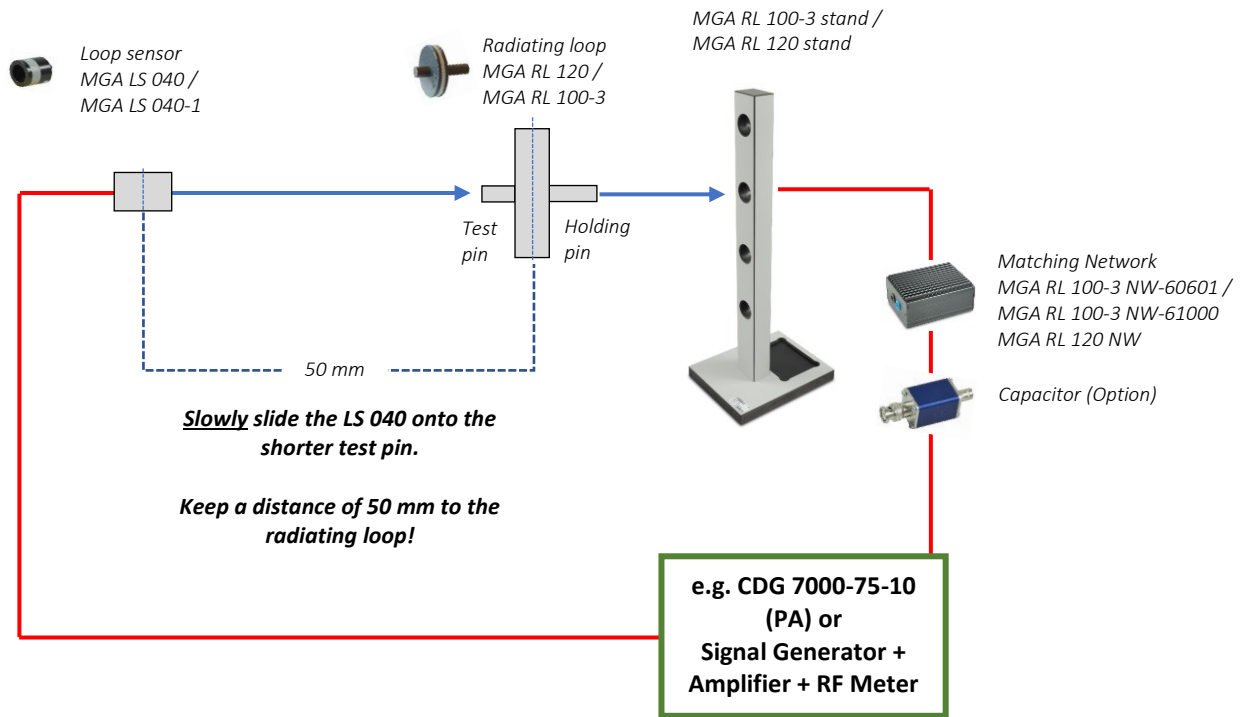

Construction radiating loop MGA RL 100-3



Construction radiating loop MGA RL 120



There is no special cable assignment required between MGA RL 100-3 and the matching transformer.



IEC 60601-1-2 ED. 4.1 / IEC 61000-4-39

New requirement, immunity to proximity magnetic fields based on IEC 61000-4-39

Sensor Loop LS 040-1, Transducer Factor

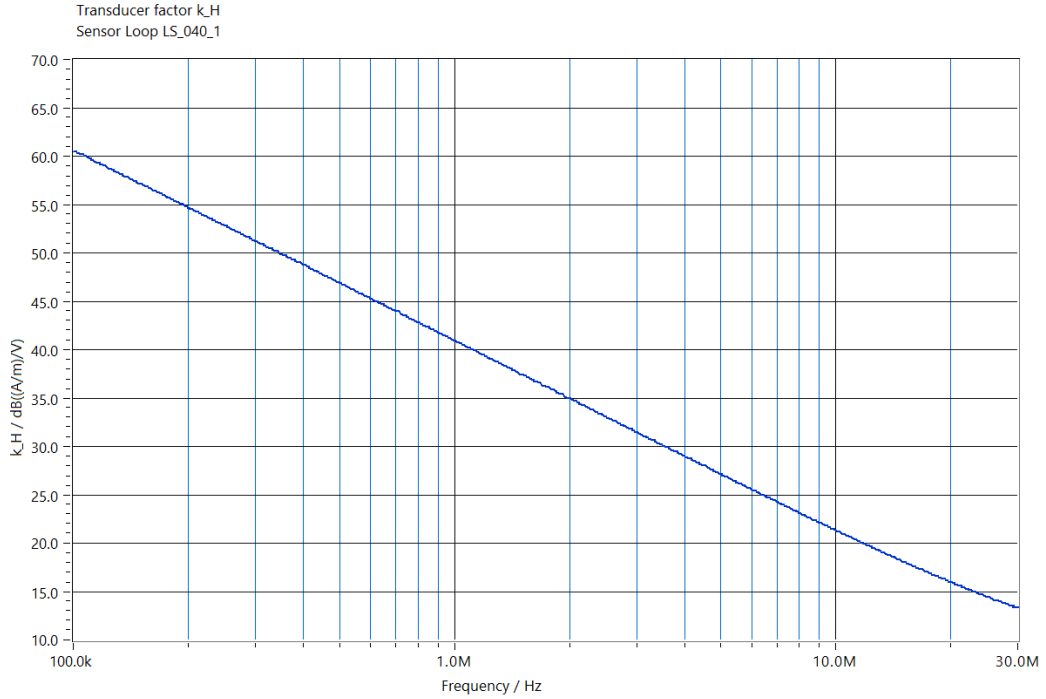

Radiating loop RL 100-3, Magnetic Field Strength

Magnetic field strength, amplifier output power: 35 dBm (3.2 W)
Radiating loop RL 100-3, with matching network (60601-1-2)

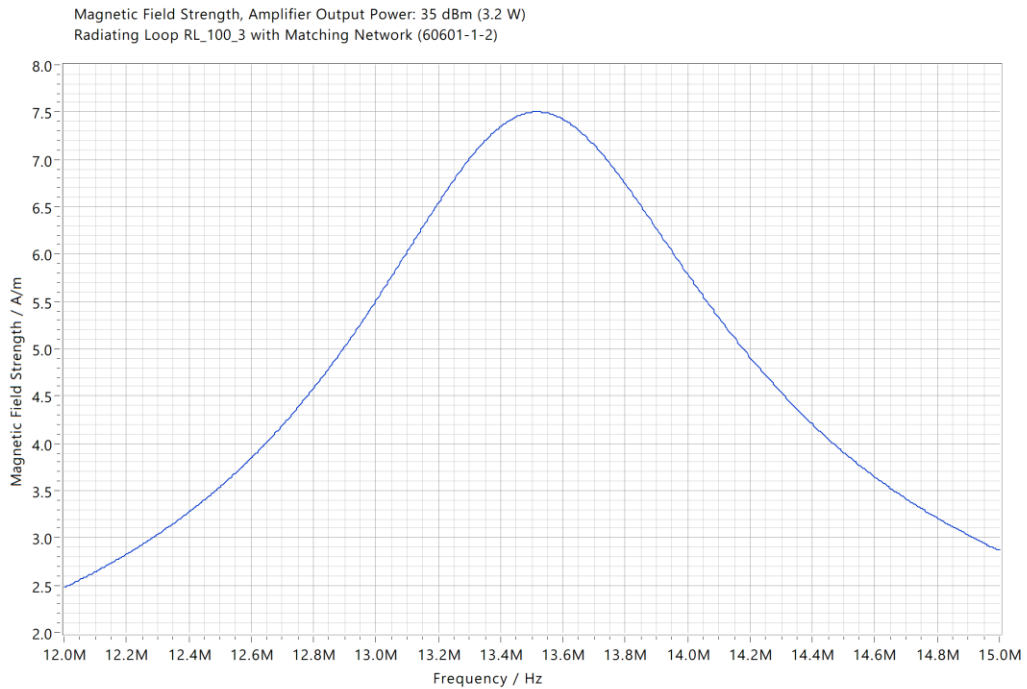

IEC 60601-1-2 ED. 4.1 / IEC 61000-4-39

New requirement, immunity to proximity magnetic fields based on IEC 61000-4-39

Radiating loop RL 100-3, Amplifier Output Power for different Magnetic Field Strengths

**Amplifier output power for different magnetic field strengths
Radiating loop RL 100-3, with matching network (61000-4-39)**

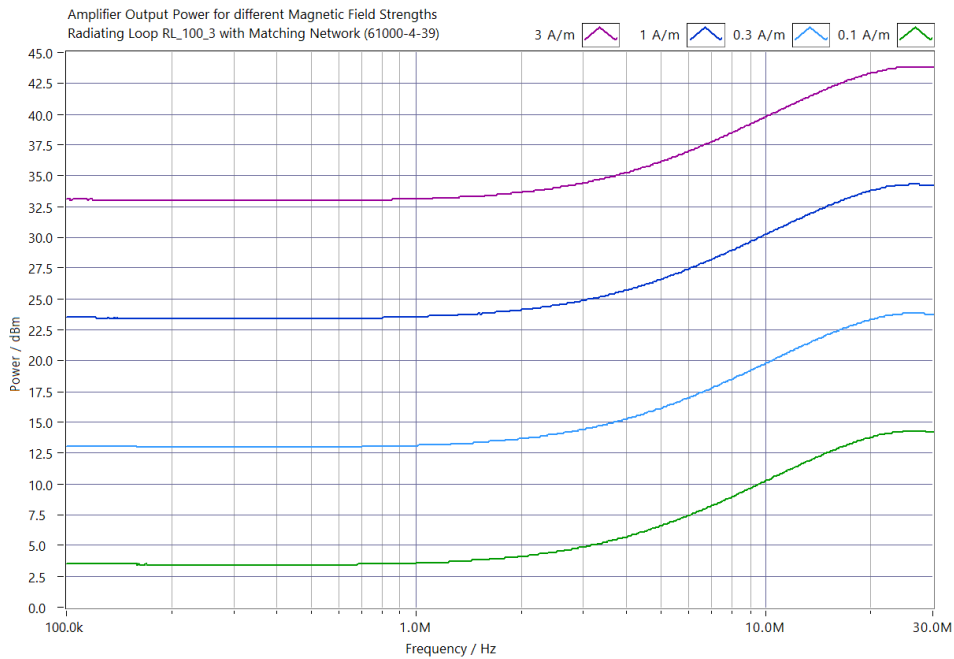

Radiating loop RL 120, Amplifier Output Power for different Magnetic Field Strengths

**Amplifier output power for different magnetic field strengths (incl. 80% AM)
Radiating loop RL 120, with matching network**

For IEC 60601-1-2, approximately 46.3 dBm is required for 65 A/m at 134.2 kHz with the same setup. This can be realized with the 75W-10 kHz amplifier. With a resonance capacitor in series with the matching network, this required power can be halved to 43.1 dBm.

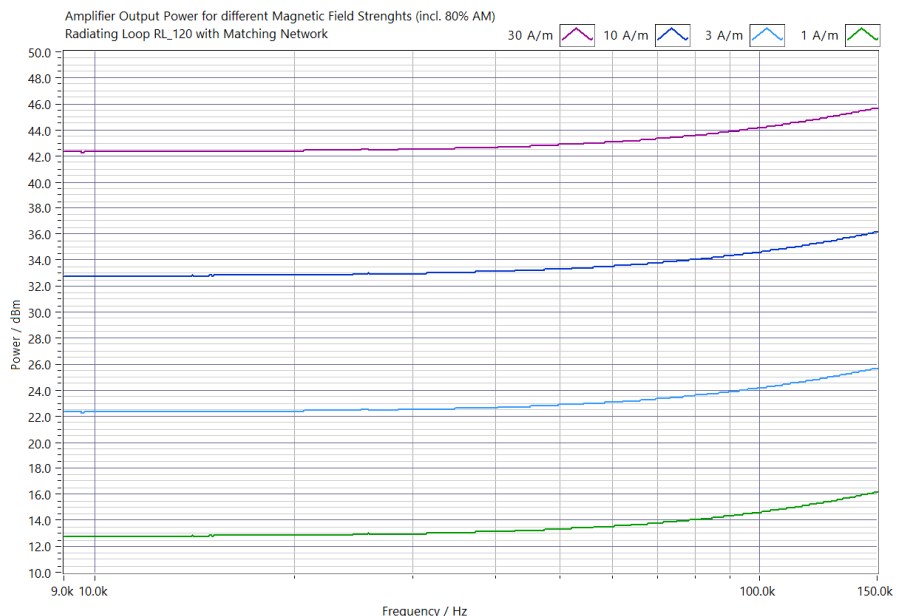

IEC 60601-1-2 ED. 4.1 / IEC 61000-4-39

New requirement, immunity to proximity magnetic fields based on IEC 61000-4-39

The following complete sets or equipment is required for the tests:

Generator, software and measurement

- **CDG 7000-75-10** - 10 kHz - 250 MHz, 75 Watt, amplifier, RF Generator, RF Meter x3 (monitored level, forward & reverse power) **only IEC 60601-1-2**
- **Option: PreAmp 150kHz-26MHz -4-39**
Preamplifier for CDG 7000-75-10 for tests according to **IEC 61000-4-39** (sensor coil LS 040-1 provides too low an output level for the CDG 7000 for the lowest standard levels at low frequencies)
- **HELIA 7-MGA software:** The system includes all cabling and HELIA 7 software required to meet the standard's requirements.

Complete set for frequency range: 9 kHz – 150 kHz

Article No.: Set 9kHz-150kHz -1-2/-4-39

Coil set RL-120 & LS-040 incl. stand and matching network for tests according to **IEC 60601-1-2 Ed. 4.1 (30 kHz, 134.2 kHz) and IEC 61000-4-39 (9 kHz to 150 kHz)**

- **MGA RL 120** – Radiating loop 120 mm as specified in IEC 61000-4-39 for 9 kHz – 150 kHz, IEC / EN 60601-1-2 and MIL-STD-461 / RS101, 3 m cable
- **MGA RL 120 NW** – Matching Network for MGA RL 120, matches loop to 50 Ohms of the CDG 7000 amplifier acc. to IEC 61000-4-39 and IEC / EN 60601-1-2 for Immunity to magnetic fields 9 kHz - 150 kHz
- **MGA RL 120 Stand** – Stand for MGA RL 120 for tests
- **MGA LS 040** – Loop sensor 40 mm
- **Cable set**

Scope of delivery:

61000-4-39
9 kHz - 150 kHz

60601-1-2
134,2 kHz

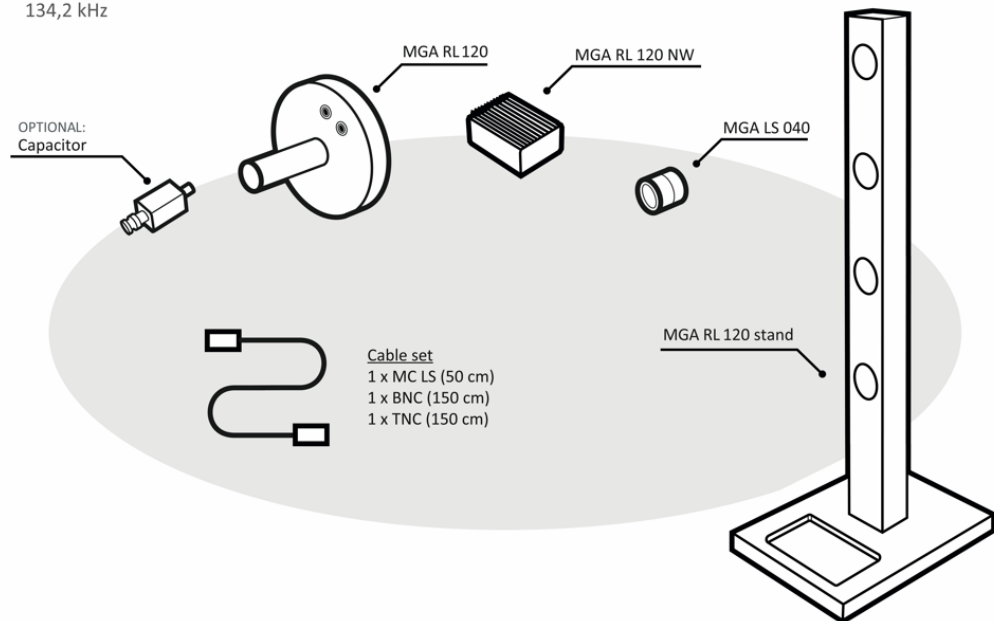

IEC 60601-1-2 ED. 4.1 / IEC 61000-4-39

New requirement, immunity to proximity magnetic fields based on IEC 61000-4-39

**Complete set for
frequency range:
150 kHz – 26 MHz**

Article No.: Set 150kHz-26MHz -1-2/-4-39

Coil set RL-100-3 & LS-040-1 incl. stand and matching network for tests according to **IEC 61000-4-39 (150 kHz to 26 MHz) and IEC 60601-1-2 (13.56 MHz)**

- **MGA RL 100-3** – Radiating loop as specified in IEC 61000-4-39 and IEC / EN 60601-1-2 for 150 kHz – 26 MHz
- **MGA LS 040-1** – Loop sensor 40 mm that attaches to MGA RL 100-3 at the correct distance of 50 mm as specified in IEC 61000-4-39 and IEC / EN 60601-1-2
- **MGA RL 100-3 stand** – for tests in stronger magnetic fields
- **MGA RL 100-3 NW-60601** – Matching Network 60601 for MGA RL 100-3, matches MGA RL 100-3 to the IEC 60601-1-2 requirements
- **MGA RL 100-3 NW-61000** – Matching Network 61000 for MGA RL 100-3, matches MGA RL 100-3 to the IEC 61000-4-39 requirements
- **Cable set**

Scope of delivery:

61000-4-39
150 kHz - 26 MHz

60601-1-2
13,56 MHz

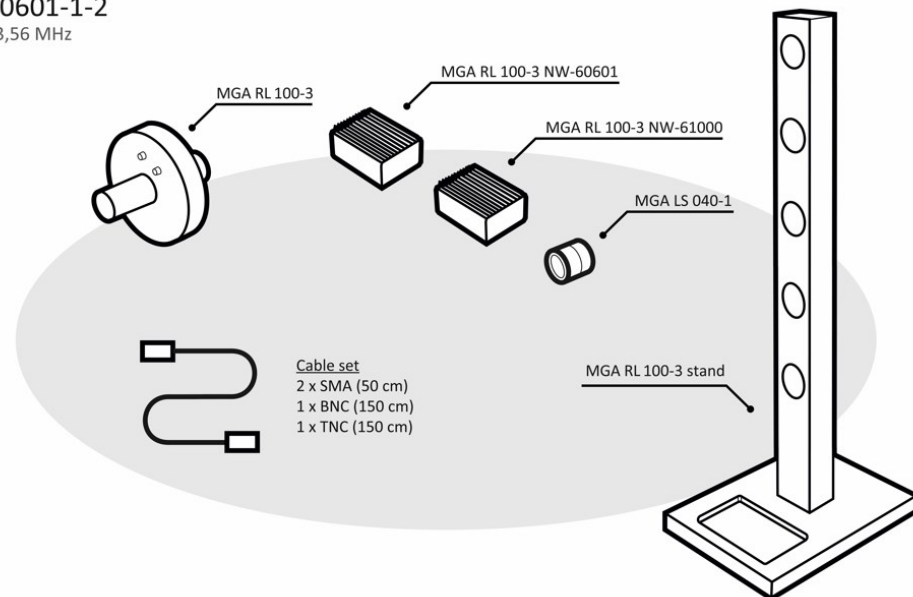

IEC 60601-1-2 ED. 4.1 / IEC 61000-4-39

New requirement, immunity to proximity magnetic fields based on IEC 61000-4-39

**Set -4-39
for
frequency
range:
150 kHz –
26 MHz**

Article No.: Set 150kHz-26MHz -4-39

Coil set RL-100-3 & LS-040-1 incl. stand and matching network for tests according to **IEC 61000-4-39 (150 kHz to 26 MHz)**

- **MGA RL 100-3** – Radiating loop as specified in IEC 61000-4-39 and IEC / EN 60601-1-2
- **MGA LS 040-1** – Loop sensor 40 mm that attaches to MGA RL 100-3 at the correct distance of 50 mm as specified in IEC 61000-4-39 and IEC / EN 60601-1-2
- **MGA RL 100-3 stand** – for tests in stronger magnetic fields
- **MGA RL 100-3 NW-61000** – Matching Network 61000 for MGA RL 100-3, matches MGA RL 100-3 to the IEC 61000-4-39 requirements
- **Cable set**

Scope of delivery:

61000-4-39
150 kHz - 26 MHz

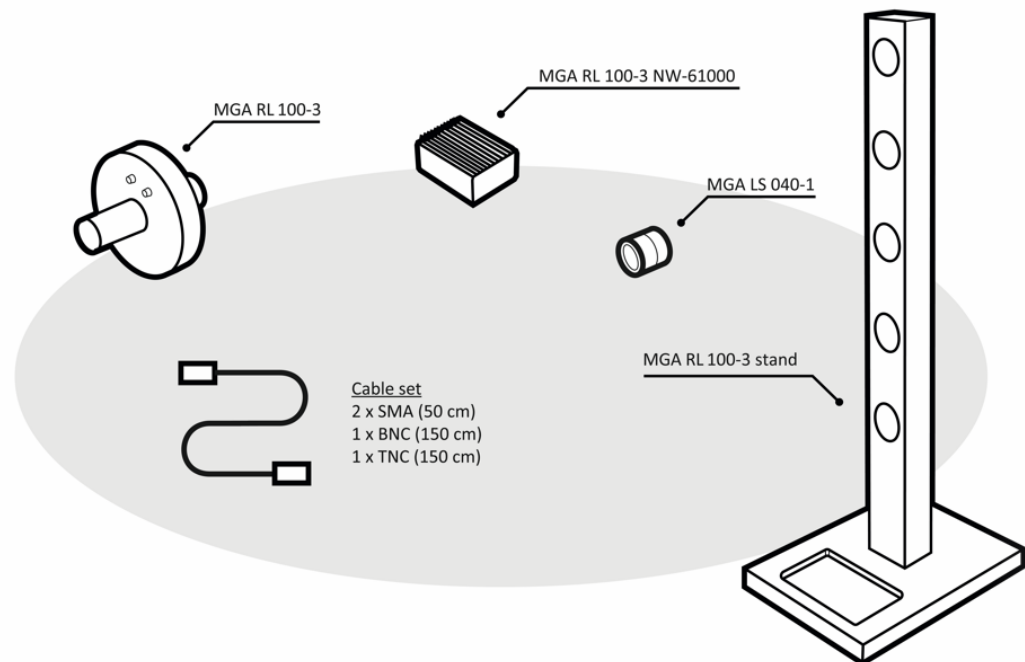

IEC 60601-1-2 ED. 4.1 / IEC 61000-4-39

New requirement, immunity to proximity magnetic fields based on IEC 61000-4-39

Set -1-2

for frequency
range:

150 kHz –
26 MHz

Article No.: Set 150kHz-26MHz -1-2

Coil set RL-100-3 & LS-040-1 (incl. stand and matching network) for tests according to IEC 60601-1-2 (13.56 MHz)

- **MGA RL 100-3** – Radiating loop as specified in IEC 61000-4-39 and IEC / EN 60601-1-2
- **MGA LS 040-1** – Loop sensor 40 mm that attaches to MGA RL 100-3 at the correct distance of 50 mm as specified in IEC 61000-4-39 and IEC / EN 60601-1-2
- **MGA RL 100-3 stand** – for tests in stronger magnetic fields
- **MGA RL 100-3 NW-60601** – Matching Network 60601 for MGA RL 100-3, matches MGA RL 100-3 to the IEC 60601-1-2 requirements
- **Cable set**

Scope of delivery:

60601-1-2

13,56 MHz

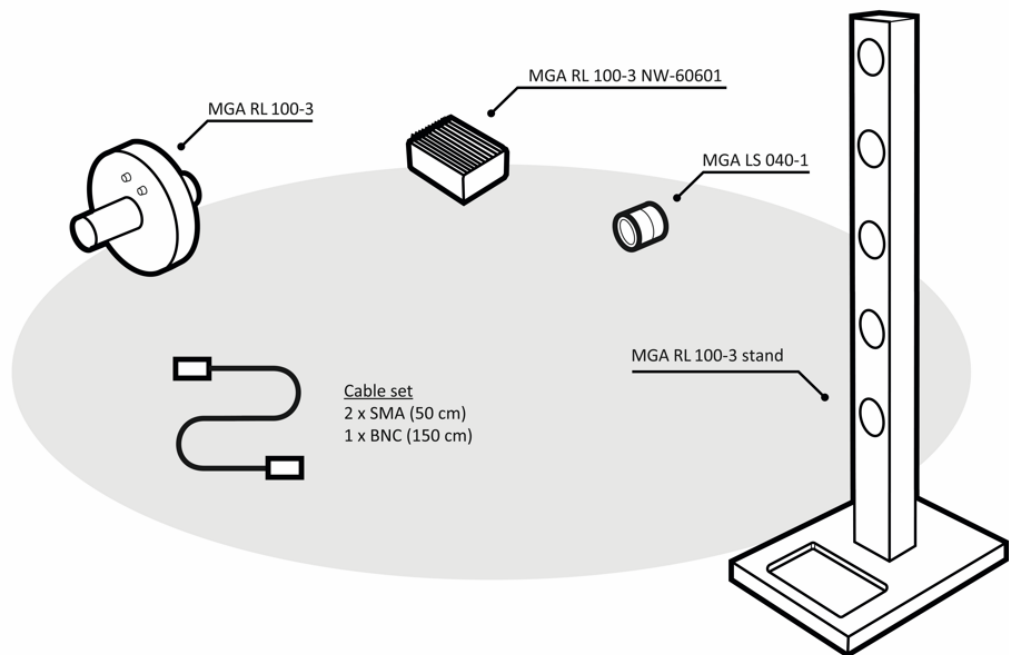

IEC 60601-1-2 ED. 4.1 / IEC 61000-4-39

New requirement, immunity to proximity magnetic fields based on IEC 61000-4-39

Upgrade for frequency range: 9 kHz – 150 kHz <i>(with existing equipment RL 120 / LS 040)</i>	Article No.: Upgrade 9kHz-150kHz -4-39 Stand and matching network for coil set RL-120 & LS-040 for tests according to IEC 61000-4-39 (9 kHz to 150 kHz) <ul style="list-style-type: none">▪ MGA RL 120 NW – Matching Network for MGA RL 120, matches loop to 50 Ohms of the CDG 7000 amplifier acc. to IEC 61000-4-39 and IEC / EN 60601-1-2 for Immunity to magnetic fields 9 kHz - 150 kHz▪ MGA RL 120 Stand – Stand for MGA RL 120 for tests▪ Cable set
Capacitor	Article No.: Capacitor 1/2W 134,2 kHz -1-2 Capacitor in housing (resonance matching) for RL-120 with matching network BNC male/BNC female. When testing for IEC 60601-1-2: 134.2 kHz, 65 A/m, the required power can be halved from 46.3 dBm / 43 W to 43.1 dBm / 20 W with the optional resonance matching. The capacitor in the housing is plugged in front of the matching network.

Added system advantage

EUT monitoring: with Digital TTL signals & analog 0-10 VDC (automate threshold and report)

EUT Fail port: Stop test or mark report

SCPI interface control for universal support (11452-4)

Conducted immunity testing to **IEC 61000-4-6, ISO, MIL, and other standards** with the use of additional accessories CDNs, EMC clamps, BCI clamps



All information regarding appearance and technical data correspond to the current state of development at the time of release of this data sheet. We reserve the right to make technical changes. 302111

