

VNA Mode for Real-Time Spectrum Analyzers



Great in Price and Performance!

Vector Network Analysis Mode (VNA, Standard):

- S11, S21 and Distance-to-error Measurement (DTF)
- Smith, Polar, SWR and Group Delay can be displayed

RTSA Mode (Real-time):

- Up to 40 MHz Real-time Bandwidth
- FMT, Density, PVT, Spectrogram

EMI Mode (Option):

- CISPR filters and QP/CISPR AV detectors included
- Automatic tests for pass/fail analyses



RSA5032N / RSA5065N

- 9 kHz to 3,2 or 6,5 GHz Frequency Range

GPSA Mode (Search):

- -165 dBm (typ.) Displayed Average Noise Level (DANL)
- -108 dBc/Hz Phase Noise

Special Offer → Until 30 June 2021 including 40 MHz real-time bandwidth and PA option

from € **7,895**
plus VAT



RSA3015N / RSA3030N / RSA3045N

- 9 kHz to 1,5 / 3 or 4,5 GHz Frequency Range

GPSA Mode (Search):

- -161 dBm (typ.) Displayed Average Noise Level (DANL)
- -102 dBc/Hz Phase Noise

Special Offer → Until 30 June 2021 including EMI and PA option

3 Years Warranty
Extendable!

from € **2,099**
plus VAT



Please sign up for our newsletter →



RIGOL's new Solution for EMI pre-compliance tests

Enhanced EMI measurement function and a simple user-friendly operating environment complete RIGOL's real time spectrum analyzer versions RSA3000N and RSA5000N.

Electromagnetic compatibility [EMC] has become one of the most important topics in the last 23 years. EMC activities during design phase are absolutely mandatory to ensure the functionality of development and to protect the environment from electro smog. Each new development must be tested in a test laboratory in accordance with related standards in order to be CE certified. This certification is necessary to bring a new product to the market. Different standards are used depending what kind of product is designed. For example standard CISPR 22 (EN55022) needs to be passed for an "information technology equipment" [ITE] like a MP3 player or a modem (telecommunication). Each standard specifies frequency ranges for conducted and radiated emission of a product and defines maximum limits in dB μ V for each analysis. Pre-compliance analysis is very important during design stage because it's estimated that ~50% of products fail the first acceptance test. A second full compliance test is very expensive and time consuming. But also a re-design has a strong financial impact and uncalculated additional time is necessary which is a question of cost in the end as well. In order to avoid this scenario, initial EMC analysis and measurements are necessary at a very early stage of development and must be carried out throughout development, including pre-compliance checks. A survey¹ shows that the average cost of EMC activities during development is at ~3-5% of whole development cost. However, if these activities will not be performed and the compliance test is failed, the cost of post-development can be arise up to 50% to 100% of the actual planned cost. For EMC analysis and pre-compliance control, RIGOL has been offering since years solution with spectrum analyzers of the series DSA800 (including 6 dB filters and quasi-peak value detector [QP]) and PC Software S1210, as well as a near-field probe set NFP-3. This solution has now been extended and optimized in the RSA3000N/RSA5000N series. This makes it possible to simplify EMC analysis considerably and also offers even more advanced analysis capabilities.

EMI Problematic

EMC² was implemented to generate a peaceful coexistence between transmitter and receiver of electromagnetic energy. Also unwanted transmitting and receiving are within this

¹ Source: „NF- und HF Messtechnik, Herbert Bernstein, ISBN: 978-3-658-07377-0, edition: 2015, §4.2.1 (page: 269)“

² EMC (Electro Magnetic Compatibility) combines EMI (EM Interference) and EMS (EM Susceptibility).

definition. Furthermore EMC should protect the recourse “electromagnetic spectrum”. Three main elements are defined in EMI (*see figure 1*)

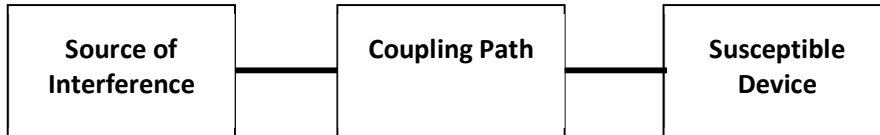

Figure 1: Elements of EMI

The source of interference could come from e.g. parasitic back coupling effects from an amplifier or an electromagnetic transmission of an electric / electronic facility. Due to different coupling path the disturbance will be coupled to the susceptible device. This interference could cause different failure rates in functionality at the EMI receptor (susceptible device):

- 1.) Performance degradation
- 2.) Function failure
- 3.) Equipment damage (worst case)

To avoid such kind of scenario it is important to detect the root cause including coupling mechanism at DUT. The EMI interferences could be transmitted via different coupling path. For lower frequency ranges the interferences are mainly transmitted via line connection (like for power, data bus, analog lines, RF connection) because the wavelength (λ)³ is bigger than the geometry and electrical and magnetically field are independent. Both fields don't propagate and a quasi-static approach is necessary (analysis of inductive / capacitive elements). The line connections need to be tested if unwanted interferences occurring during / after activation of DUT at these lines. This kind of test is named conducted emission.

When the wavelength of a DUT is equal or smaller than its frame, then magnetic and electric field are no longer independent and they start to combine to an electromagnetic field (EM). If e.g. the geometry has $6 * \lambda$ then the EM field is no longer only at the source, propagation happens and the DUT start to send out an EM wave (its acting as an antenna). Unwanted interferences with EM waves are named radiated emission. In the near field of the EM source a quasi-static approach is necessary.

The occurrence of interferences is in most cases unforeseen and difficult to detect because different coupling effects could be root cause of interferences. For a device under test there are two main influences of interferences. First one is an interference which is related within one DUT and has an influence of functionality within the device under design. These interferences are intra-system disturbances which will be occurred e.g. crosstalk effects.

³ Wavelength (λ) of a frequency (f) is defined with the speed of light ($C = 3 * 10^8$ m/sec.): $\lambda = C / f$. For example the wavelength of 1 GHz: $\lambda = 0,3$ m (30 cm). With e.g. geometry of 1.2 m a 1 GHz wave (or higher frequencies) will be propagated.

On the other side, the DUT might be affecting a complete different independent system with EMI interferences which are inter-system disturbances. For example, at a radio it could be happened that a specific noise is hearable over the speaker when a mobile phone is ringing.

Interferences could be coupled by:

- Galvanic coupling (G-C): when two electric circuits using same impedance (e.g. same GND)
- Inductive coupling (I-C): when two (or more) conductor loops with current flow influence each other with magnetic field
- Capacitive coupling (C-C): when two electric circuits have different voltage potential
- Electromagnetic coupling (EM-C): Wavelength is smaller than the geometry and EM wave radiated to environment of DUT and / or other sections of DUT.

To find a root cause coupling path in a DUT is very difficult, because coupling path could also be a combination of different couplings (e.g. G-C and C-C. at the same time). To find a solution for a detected coupling path is comparatively simple.

The next part of this document describes the test tool RSA5000N with the new EMI mode which is the tool for pre-compliance analysis.

EMI Mode of Real Time Spectrum Analyzer RSA5000N / RSA3000N

The RSA5000N / RSA3000N are multifunctional spectrum analyzer including a general purpose spectrum analyzer [GPSA], a real time analyzer [RTSA], a vector signal analyzer [VSA], vector network analyzer [VNA] and an EMI mode for pre-compliance tests. Therefore these devices are the best combination of high performance and flexibility and an optimal test solution for EMI pre-compliance analysis. For some EMI measurements, the real time mode could be a big benefit for some analysis to get a better overall picture of the problem or see more behavior of DUT. The GPSA mode could be used to measure single components of a DUT like an amplifier and with VSA mode, the modulation quality or BER of an RF output could be measured e.g. during susceptibility stress.

The new EMI mode offers a lot of new functionalities and advantages for pre-compliance tests and will be described in detail:

Scan Table

During the conformity check (conducted and radiated emission / susceptibility), a test receiver [TR] is generally used in a test laboratory. However, a TR has several disadvantages. It is a very expensive test tool and only usable in the field of EMC. A spectrum analyzer [SA] on the other hand, measures faster and can be used for different applications and is significantly cheaper, especially at RIGOL. However, a TR has significant advantages in EMC measurements comparing to an SA. TR using a pre-selection which allows to use a different

dynamic range for each partial measurement. In addition, the desired frequency resolution (usually RBW/2 and sometimes RBW/4) is easily achieved in a TR. The SA fulfils the most of CISPR 16.1 requirements and the results are a very good approximation, which is absolutely sufficient to perform pre-compliance tests. A TR fulfills CISPR 16.1 for 100% and can also be used for compliance tests. RIGOL's new EMI solution in the RSA5000N / RSA3000N compensates most of the disadvantages with the scan table. The most used frequency ranges inclusive the correct 6 dB RBW filter for EMC tests are pre-defined in 10 individual ranges (see figure 2). All pre-defined settings can be modified / stored according to the own need. In order to compensate these disadvantages in a SA, the EMI solution of RIGOL stores the basic setting of the most important frequency bands, including the 6 dB RBW required, in a scan table in advance (see figure 2) in individual areas [Ranges]. All parameters can be adjusted separately per area according to your own wishes.



Figure 2: Scan table

For example, it is possible to use up to 10,000 measurement points per area. The basic settings of measurement points refer to a frequency resolution of RBW/2. For a higher resolution, different ranges can be combined for one test. With a combination of e.g. 3 ranges it is possible to use 30.000 measurement points over the whole frequency to reach expected resolution if necessary. The integrated pre-amplifier (option) and internal attenuator (0 to 50 dB) can be varied per range as well. With combination of different ranges it is possible to increase the dynamic range of the complete measurement without interrupting the measurement itself, because the dynamic range can be adjusted for each single range. The disadvantage of frequency resolution and dynamic range in an SA can be compensated in EMI mode. Additionally to the standard 3 dB RBW filter, the EMI solution contents also the

integrated 6 dB filters (200 Hz, 9 kHz, 120 kHz and 1 MHz). Especially RSA5000N providing real time and vector signal analysis capabilities, which is not the case with a TR.

Integration of Limits According to Standards

After the desired frequency range has been selected, you can load the pre-defined and stored limit lines of the desired standard (e.g. EN55022, Class B, AV or/and QP) and display it on the fully logarithmic trace display. A measuring curve can be assigned to each limit. It is possible to activate a measurement curve with a separate detector setting for each pass/fail limit. Different measuring curves can also be measured at the same time. For each limit line it is possible to activate an additional security margin, which is considered in the Pass/Fail viewing. Especially in the pre-compliance check the result should be at least 5-6 dB below the defined limit line to ensure, that the compliance check will be passed.

Advanced Meter/Additional Detectors/Corrections

Another advanced measurement mode is the measurement meter. It is possible to activate up to 3 meters in parallel. Each of them can be used with different detectors and separate limit values. For example, the peak value detector [peak] can be set for first meter, second meter is set to QP detector and third meter to the new CISPR Average [C-AV] detector. The respective measuring meters can be set to the peak under focus via meter marker. The meters measures continuously. This means, for example, with an elevated peak value, the DUT can be reworked and the influence on this value can be immediately represented. A design improvement is immediately visible. With using three meters in parallel it is possible to see the peak measurement (worst case) but also the repetition pulse rate of this signal over a certain time with QP detector can be displayed. In addition a weighted average detector can be used for pulsed sinus-shaped signals with low repetition rate (C-AV⁴) which displays the maximum linear average value during the measurement.

The meters can be coupled with a signal which is selected in the signal table. An additional fine-tuning of the meter frequency is not necessary. So each peak in signal table can be selected and measured by marker, as well. Alternatively, the meters could be coupled to a marker. For conducted emission tests additional components are used (e.g. line stabilization network (LISN) transient limiters, external attenuator, etc.). Each of the components has a direct influence of test result over frequency range. Therefore, it is possible to activate different corrections in RSA3000N / RSA5000N EMI mode. During the test, the correction will be respected in the result. Correction values can be stored internal the instrument, as a *.csv file. These can also be generated in the PC and loaded later on into the analyzer.

⁴ CISPR Average detector is a new definition in CISPR16.1 and replaces the Average detector for some standards. C-AV contents an instrument time constant according used low pass filter for Band A, B, C/D and E. IF bandwidths are the same as for QP (200 Hz, 9 kHz, 120 kHz, 1 MHz). C-AV is used to measure low frequency pulsed sinusoidal signals (signals with fp < 6Hz). C-AV is calibrated with unmodulated sinusoidal signal (rms).

Measurement

Different conditions can be set for the measurement. On the one hand, variable traces can be recorded at the same time with one or more detectors. Alternatively, only the worst case situation (peak detector) can be recorded. Afterwards each peak in the signal table will be measured with QP and C-AV detector, as well. It is no longer necessary to perform a whole trace with QP and C-AV (duration can be several hours) because these detectors are only interesting when peaks are visible and the test engineer has the information in some minutes and saves a lot of time during pre-compliance evaluation.

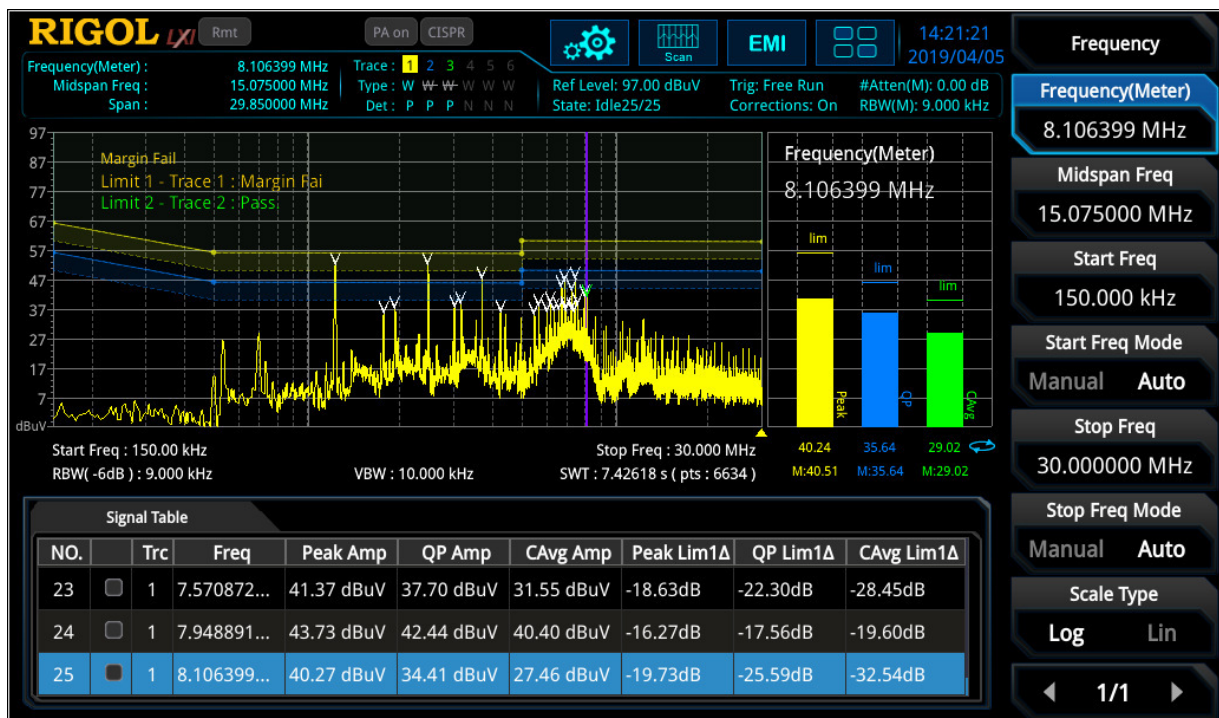

Figure 3: View of EMI measurement with the trace, meters (right side) and signal table (below) with results

The number of readings in the signal table can be pre-defined. In order to get a detailed view of a peak value, a zoom is available to enlarge a detailed view of a peak. After analysis, the view can be zoomed out to get back the original view.

In case that the full screen of the trace is required, the measurement meter and the signal table can be turned off on the screen.

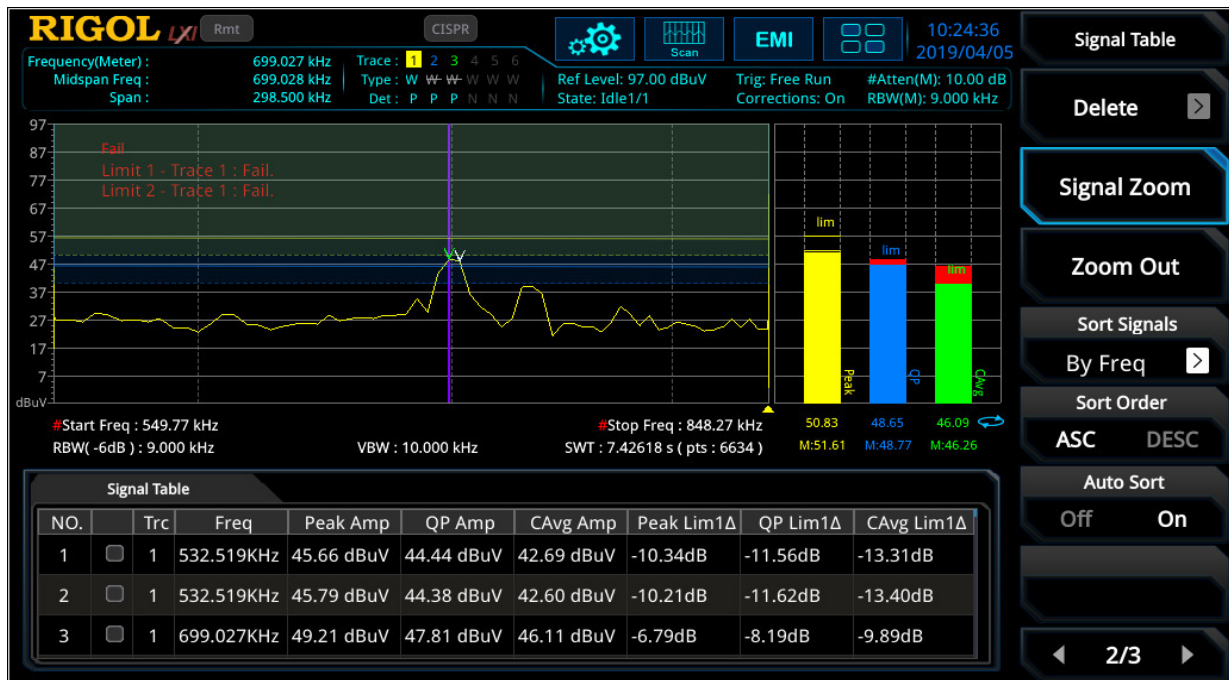

Figure 4: Zoom View of a Peak Signal

Documentation

In the EMI mode of RSA5000N / RSA3000N series, the measurements can be stored in different ways. For example, the complete signal trace can be stored as a *.csv file or a test report including settings, limits, an image of the graph including meter result and the signal table can be created as HTML or *.pdf in the analyzer itself or on an external USB stick. It is possible to modify the header of the test report with information like temperature / humidity, name of operator or test location, etc.

The next part of this document will go through some measurement examples with conducted / radiated emissions and near field probing.

Conducted Emission

As already mentioned, conducted emission is mainly measured up to 30 MHz at lines (e.g. power, analog / digital signals, etc.). For conducted emission test on power line it is necessary to supply the DUT with power. At the same time the disturbances from DUT shall be measured. The problematic is, that also from the power supply disturbances could be send out which shall not be measured. Another aspect is the impedance matching to avoid a wrong result based on an impedance mismatch. The solution for this problematic is the usage of a line impedance stabilization network [LISN]. A LISN blocks all interferences (via inductive component) from power supply to SA, but supplies a DUT with power. Depending on inductive size, a LISN can be used for DC (5 μH) or AC (50 μH) power source. The power will

be blocked on the way to SA (via a capacitance) but the DUT disturbances won't be blocked and transferred to the SA. The impedance at SA connection is 50 Ω.

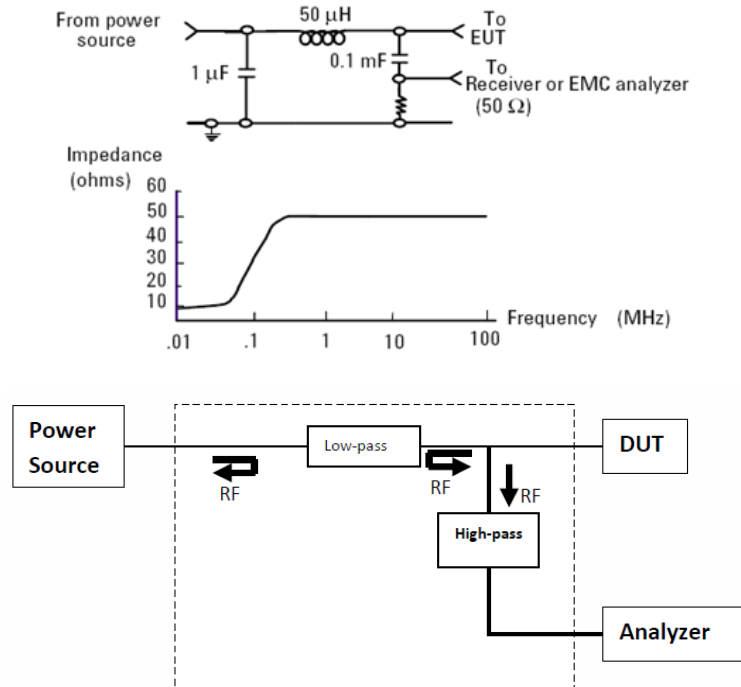

Figure 5: Block Diagram of an AC LISN

Two security mechanisms are important using a LISN. When a LISN or a DUT will be activated, then the electric charge of capacitance changing and current flows for a short period. This transient current can destroy the first mixer diode in a spectrum analyzer. It is recommended to use a transient limiter between LISN and SA, to protect the analyzer⁵. For the first test it is also recommended to use an external attenuator for the test to see if high disturbances will occur from DUT. The attenuator can be removed after first test, when the user is sure, that the disturbance peaks are at a normal level.

In each standard it is defined how the test setup has to be performed. **In figure 6** there is the physical connection of a test setup displayed:

⁵ Several LISN already have a transient limiter integrated. Please check data sheet of a LISN for more information

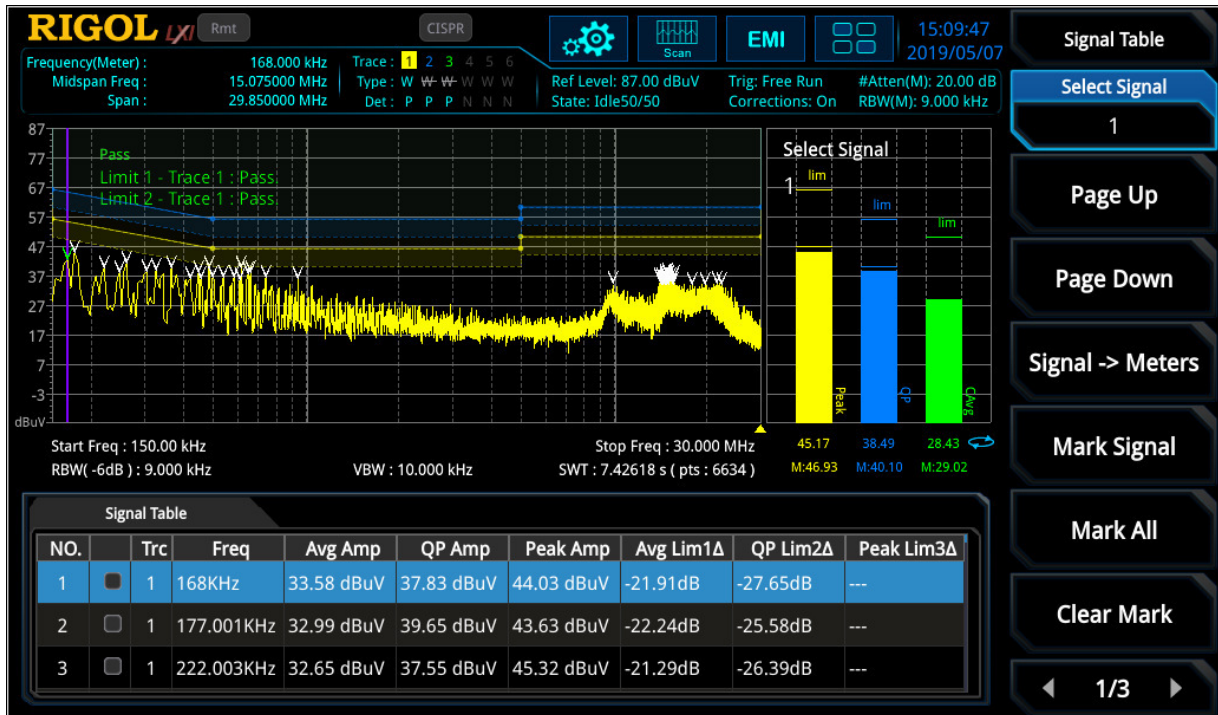

Figure 7: Conducted emission test (acc. to EN55022, Class B) for a power supply of an ITE device

Additionally to EMI analysis the frequency band can be analyzed in real time [RT] as well. This mode uses a very fast FFT algorithm to calculate the frequency spectrum. The calculation time is smaller than one FFT frame. Therefore a seamless capture of time signal is possible and no signal information⁷ will be lost. In RT mode different displays can be used. For example within density mode it is possible, to see a signal repetition over test time in different color grades and therefore it's possible to see more details. Density or Normal view could be combined with spectrogram (time waterfall over frequency range) where different amplitude values are displayed in diverse color grades (*see figure 8*).

⁷ POI: 7,45 μsec @40 MHz RTBW

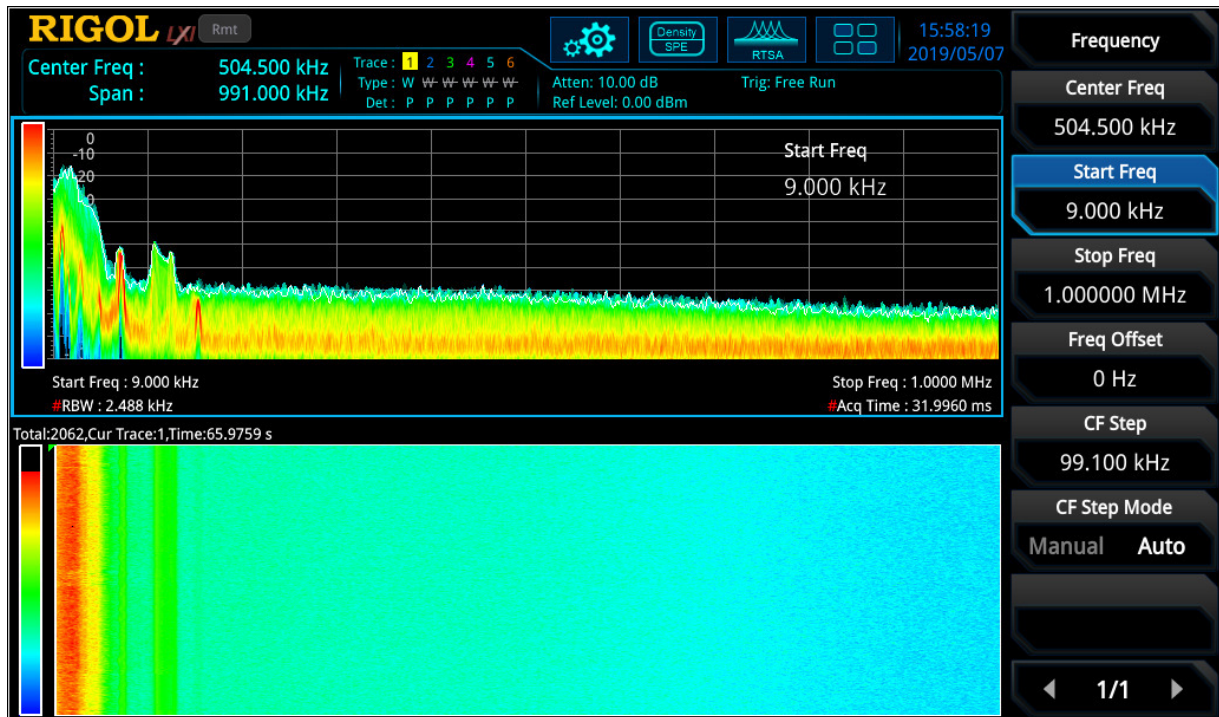

Figure 8: Real-time view (Density Spectrogram) of a power supply with interferences in low frequency range

An additional strong tool is the combination of frequency view and power vs time (with bandwidth up to 40 MHz⁸) in parallel. For a SA it is only possible to view the frequency spectrum or zero span with the max bandwidth of used RBW but not both in parallel. In **figure 9** the same DUT was tested with smaller frequency range and with normal spectrum in combination of spectrogram. For this measurement it's possible to speed up test time to 100 μ sec. The interference pulses are now visible in spectrogram. With a Z marker it is possible to measure the difference in frequency, amplitude and time of an interference signal.

⁸ RSA5000: Standard BW is 25 MHz, 40 MHz is an option. RSA3000: Standard BW is 10 MHz, 25 MHz or 40 MHz is an option

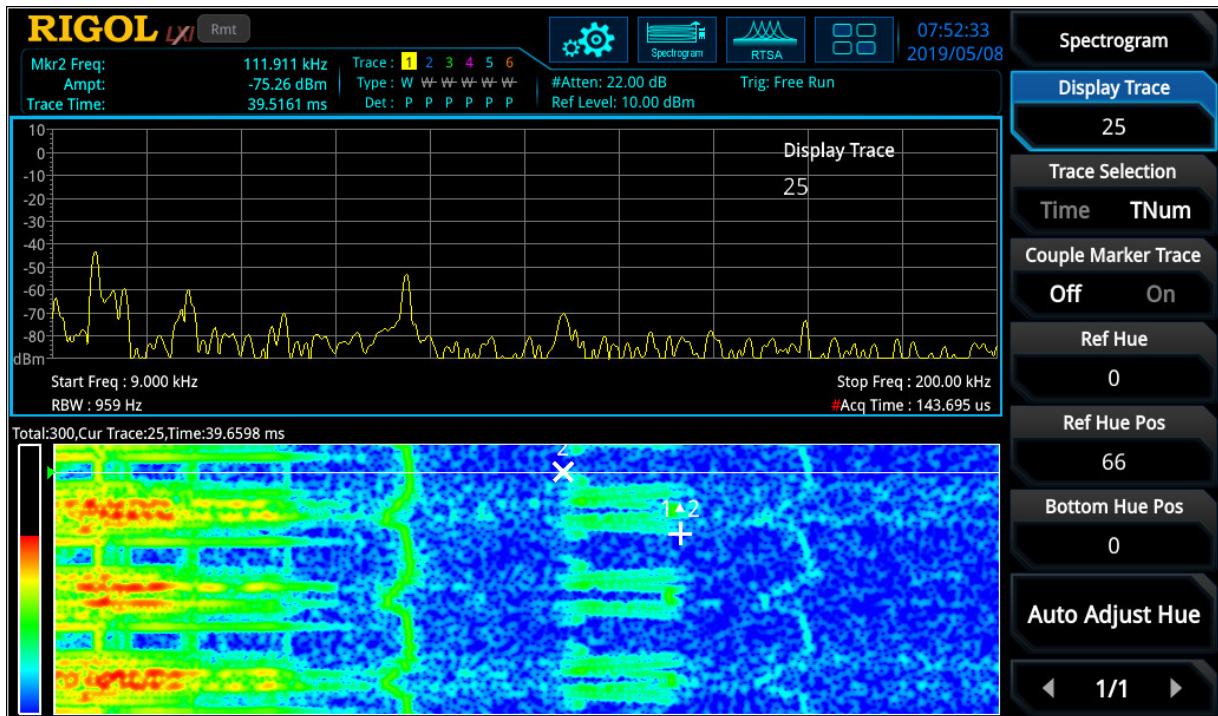

Figure 9: Interference measurement of power supply with acq. time of 143 μsec and Z marker evaluation

Near Field Probing

Near field analysis is a very important part in pre-compliance analysis and root cause debugging. RIGOL offers with the set of near fields (NFP-3) 4 different H probes for failure detection (*see figure 10*). It is a special form of emission analysis, because the measurement is done in reactive nearfield range (up to $0.159 * \lambda$)⁹. In near field magnetic and / or electric field needs to be measured separately because both have a phase shift of up to 90° and nearfield stores blind energy without radiation. For most radiated emission root causes can be detected with locating the near field strength.

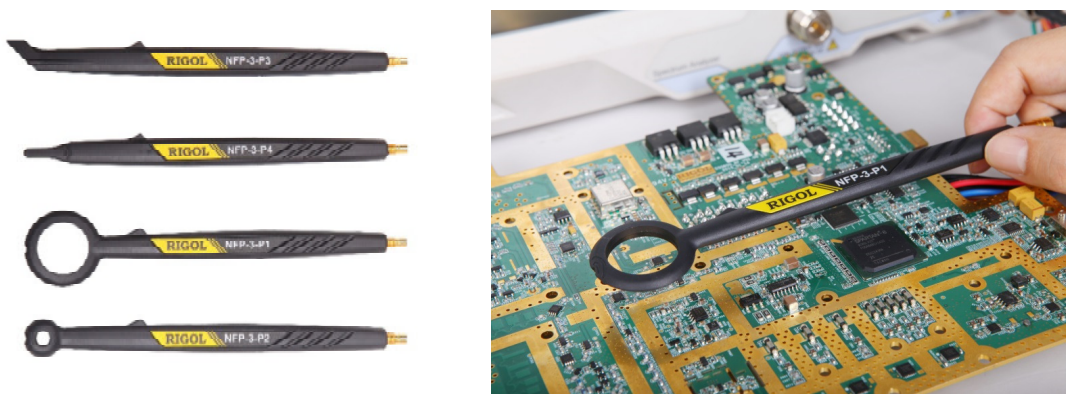

Figure 10: NFP-3 (near field probe set) for EMI debugging

⁹ Near field distance of 3 GHz: up to 0,0159 m (1,59 cm); near field distance of 30 MHz: up to 1,59 m

Tests on housing leakage could be detected as well as strong disturbance components like ribbon cables or LCD panels. Bigger probes are usable to find the area of interferences. Smaller probes can be used to detect the exact source.

One approach for near field analysis is to use the spectrum analyzer with linear frequency scale / no limit lines and test e.g. a frequency range of 30 MHz to 500 MHz with a RBW of 100 kHz and activation of pre-amplifier (internal attenuator: 0 dB) to get a first view the interference peaks of DUT (*see figure 11*).

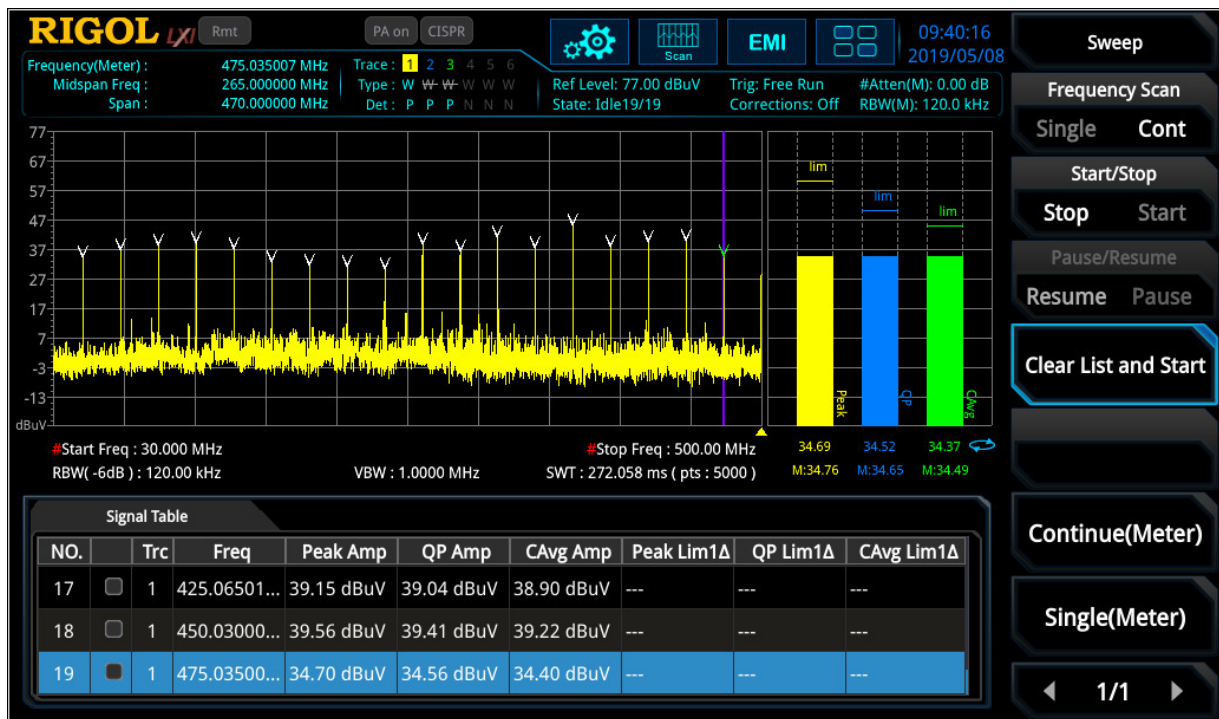

Figure 11: First overview of DUT interferences with near field probing

Radiated Emission

According to the description at the beginning, propagation starts when λ is small to the geometry and E & H are no longer independent. Both are in-phase and propagate to the environment. Radiated emission is not easy to test. In a test laboratory a big hermetic test chamber is used where far field conditions are fulfilled and other influences (due to external components like a mobile phone, etc.) are not visible in the result. Far field condition starts with a distance of $4 * \lambda$ and the characteristic wave impedance is $120 * \pi \Omega (= 377 \Omega)$. The hermetic room has in most cases at the wall broadband absorber for impedance matching of EM wave to avoid reflections. The altitude of broad band antenna can be changed during a test to find the highest peak at DUT during the test¹⁰.

¹⁰ Because of „2 way propagation“ with direct beam and one reflection point on earth

In most cases such kind of test chamber is not available for pre-compliance analysis. Therefore alternative ways has to be evaluated.

First of all, it is possible perform a free field measurement with the distance of radiated near field which is defined for $0.159 * \lambda$ to $4 * \lambda$. In this region a far field evaluation is possible (with using correction values). To detect the test area attenuation¹¹ from environment it is possible to perform a test with a counter antenna instead of DUT and the results will be compared with defined formula of theoretical value. The difference is the test area attenuation. Depending on the distance between antennas, variable correction factors are used. This test needs a very good conductive ellipsis area¹². There shall be no conductive obstacles greater than 5 cm within the ellipsis (*see figure 12*). DUT and test antenna are located within the focus of ellipsis. It is necessary to perform an altitude variation of test antenna to detect maximum.

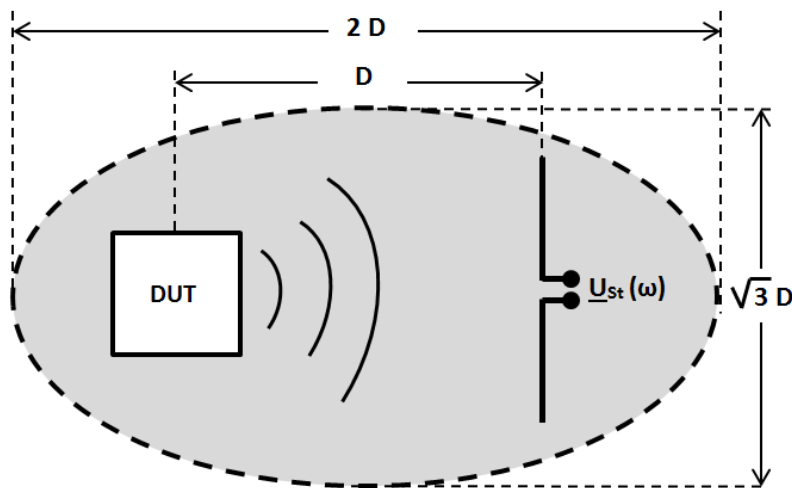

Figure 12: free field measurement for radiated emission

This test is very time intensive and expensive. A more simple way of radiated emission analysis for pre-compliance test is, to use a TEM cell.

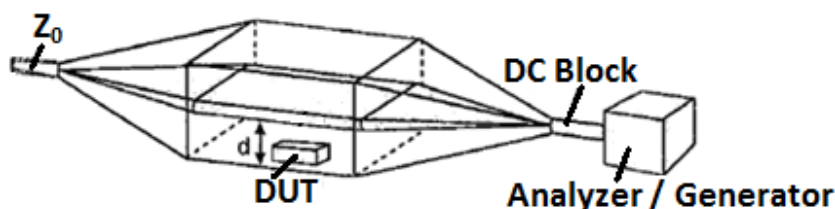

Figure 13: Double port TEM cell

¹¹ It could happen that obstacles outside the ellipsis occurs unwanted reflections. Therefore the test area attenuation needs to be evaluated, first.

¹² This could be realized with metal foil or with a wire mesh area

A characteristic for radiation of antennas is the far field. According to the description above, the characteristic wave impedance $Z_F = \underline{E} / \underline{H}$ which is in far field, is 377Ω . The idea of a TEM¹³ cell is the medium of a coax cable which is suitable for a TEM wave propagation. The characteristic wave impedance in a coax cable is independent of the mechanical structure and always 377Ω . A TEM cell is displayed *in figure 13*¹⁴. A common use for pre-compliance analysis is, to use an open TEM cell with disadvantage to see influence from environment. But this could be evaluated as a reference measurement with deactivated DUT. The two bends on the roof are necessary for the matching, but results into a frequency limit (max frequency range) is the cut off frequency based on the generation of higher wave guide modes on these bends which have an influence on test results. This cell can be used for susceptibility stress of a DUT but can also be used for repeatable pre-compliance radiated emission approximations which are sufficient for pre-compliance analysis. The connection to a spectrum analyzer needs a DC blocker because the lowest cut off frequency of a coaxial cable is 0 Hz (= DC) which could destroy a spectrum analyzer. For impedance matching of septum¹⁵ it is necessary to use a 50Ω Termination on second port to avoid reflections. The DUT is placed between septum and lower shielding plate. A test setup is visible *in figure 14*. The advantage of open TEM cells, failures can also be analyzed in parallel with a near field probe to detect the root cause area of DUT.



Figure 14: Repeatably radiated emission analysis with an open TEM cell

¹³ TEM wave is a transversal electromagnetic wave which describes a homogeneous plane wave.

¹⁴ Source of picture: „Elektromagnetische Verträglichkeit, Adolf J. Schwab / Wolfgang Kürner, ISBN: 978-3-642-16609-9, edition: 6, §5.7.3 (page: 231)“

¹⁵ Septum of TEM cell is the center core of coaxial structure. The mechanical design is to reach the impedance of 50Ω over specified frequency range.

Susceptibility Analysis

Near field probes, current probes and TEM cells can also be used for conducted / radiated susceptibility stress of a DUT. RIGOL’s RF generator series DSG800 or DSG3000B are an optimal tool in combination with those components, to stress a DUT with an amplitude modulation [AM] e.g. according to IEC 61000-4-3¹⁶, A functionality during stress might be controlled via the oscilloscope MSO8000 to see e.g. influence to jitter of clock signals or wrong decoding of bus systems or to see crosstalk effects on strip lines. Conducted susceptibility could be done with a current probe over the related stress cable. Also the real time spectrum analyzer can be used to measure, in parallel, sporadic interference reaction at DUT due to susceptibility stress. The real time functionality offers different trigger types. One is the frequency mask trigger [FMT] which is a defined field (different color) and the RTSA measures only, when the conditions of the field is fulfilled (e.g. measure, when a signal is inside the FMT field, *see figure 15*).

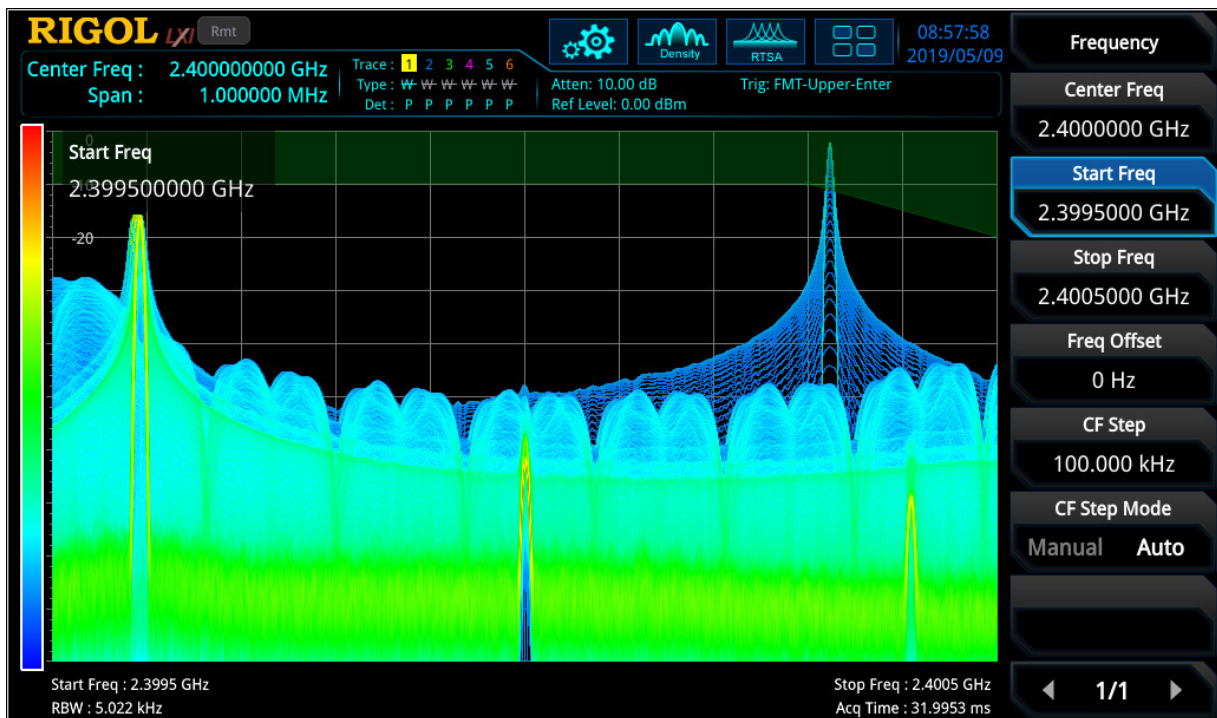

Figure 15: Measurement of sporadic interference reaction due to susceptibility stress

¹⁶ Sine wave, 1 kHz, 80% modulation depth, sweep from 80 kHz to 1 MHz

The quality of digital modulation of RF interface during absorption stress can be tested via RSA5000N VSA (*see figure 16*). Here it is possible to display also I and Q stream separately to see which part of transmitter is affected by the interference. Additionally a BER test could be performed during stress situation.

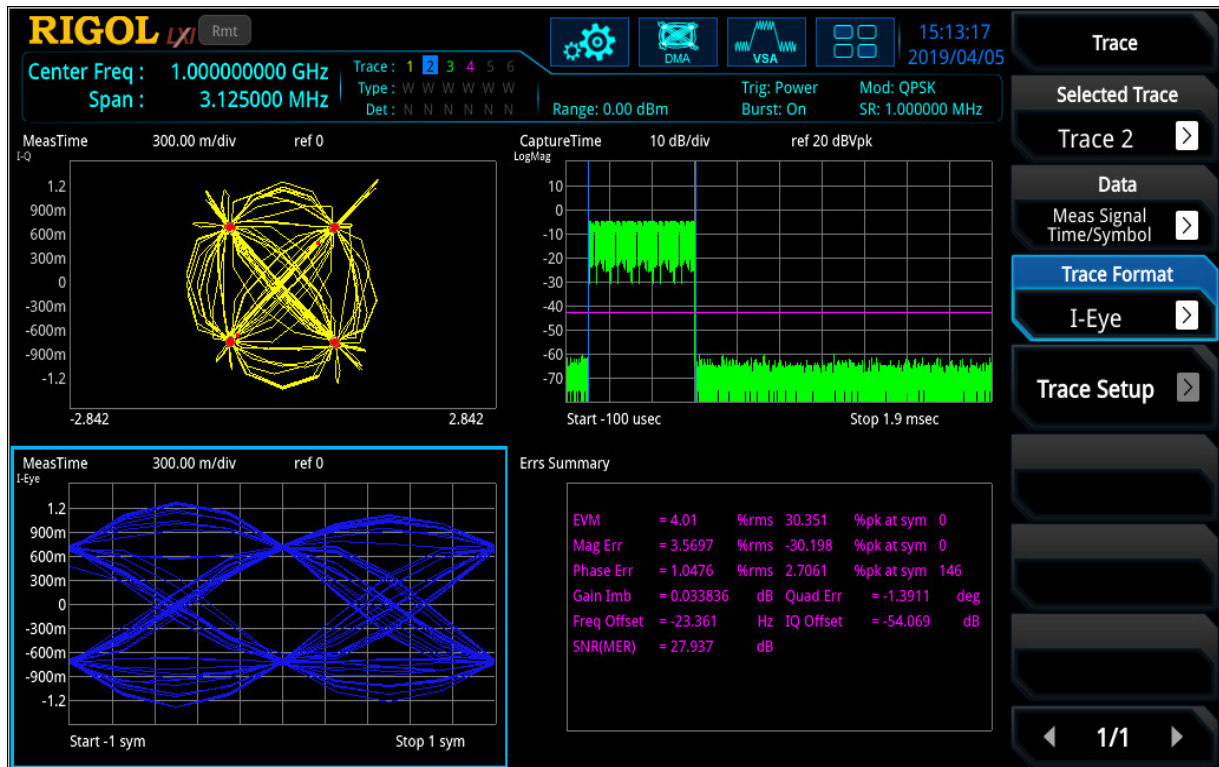

Figure 16: Digital modulation analysis at RF interface during stress situation

Additionally, with the vector network analyzer function [VNA] it is possible to measure out related antennas or other components to see if a possible degradation of performance is visible (*see figure 17*).



Figure 17: VNA Mode with different window of S₁₁ parameter like smith- and Polar Plane, logarithm. Magnitude and SWR

Summary

RIGOL offers a new dimension of pre-compliance testing with the new EMC solution for the series RSA3000N/RSA5000N. With the additional meter measurement method high peak values can be determined and improved at a very early design stage. This test solution eliminates the need for PC test software. The EMV analysis is also greatly simplified by the pleasant operation of the device (touchscreen or operator panel as well as USB mouse or USB keyboard). In addition, the real-time capacities (real-time is integrated as standard) of the RSA series provide an expanded insight into EMC analysis.