



**Space Qualified
Components**



Waveguide Products



**Standard Gain and
Wide Band Horns**



Waveguide Terminations



Coaxial Products



**Phase Shifters
and Attenuators**

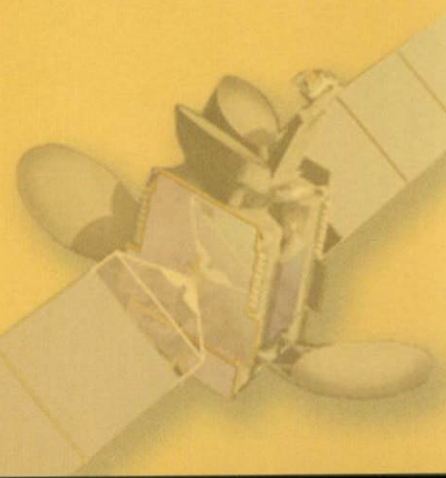
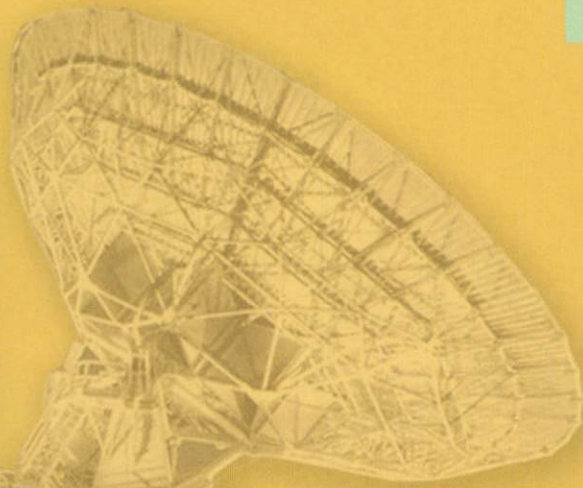



ATM: WHO WE ARE AND WHAT WE DO

Advanced Technical Materials [ATM] is a precision microwave component engineering and manufacturing company providing a wide range of RF and Microwave [to 60GHz] components [both Waveguide and Coaxial], assemblies and custom products.



National Quality Assurance accredited



Space Systems Qualified



RoHS Compliant



Reach Compliant



ITAR Registered

- WAVEGUIDE PRODUCTS** Rectangular [WR] and Double Ridge [WRD], Rigid, Flexible WG, Directional Couplers [Crossguide, Loop and Multihole], Adapters and Horn Antennas, Terminations, Windows, Quick Disconnects, Arc Detectors
- COAXIAL PRODUCTS** Variable and Fixed Attenuators, Phase Shifters and Line Stretchers, Power and Hybrid Divider/Combiners, Directional Couplers, Microwave Noise Sources and Flexible Cables
- CUSTOM PRODUCTS** Microwave components and assemblies designed to meet customer specs from simple modifications of standard products to complex assemblies. Space Qualified components for flight vehicles and Vacuum conditions..

ATM was founded in 1990. Main engineering and manufacturing are in Patchogue, Long Island, New York, USA. ATM uses the latest 3D modeling CAD and NC manufacturing methods to achieve state of the art precision products having repeatable superior performance with decreased cost and delivery times. See a selection of our products in this catalog, and be sure to visit ATM on line at www.atmmicrowave.com for the full range of products with specs and drawings.

PRODUCT INDEX

COAXIAL PRODUCTS	Page	WAVEGUIDE PRODUCTS	Page
ATTENUATORS - FIXED		ADAPTERS - Waveguide to Coax	
Fixed (DC-40GHz)	5	Rectangular & Double Ridge, Right Angle & End Launch . . .	8
ATTENUATORS - CONTINUOUSLY VARIABLE (CVA)		ATTENUATORS	
Flat, Level Adjust, Multiband (0.7-40GHz, 5W)	2	Hi Power Fixed	12
High Power (30W, 50W, 250W)	3	Continuously Variable Attenuators [CVA]	12
Miniature (DC-1GHz)	3	BENDS & TWISTS & MITERS [Rectangular and Double Ridge]	7
Rotary Step (DC-2.50GHz)	3	COMBINER-DIVIDER Short Slot Hybrid (4 port)	9
CABLES - FLEXIBLE	6	COUPLERS	
CIRCULATORS / ISOLATORS	6	Broadwall, Crossguide, Loop [WR & WRD]	9 & 10
COMBINERS, POWER		Short Length High Directivity	10
2, 4, 8 Way, 30W, SMA or N	4	FLEXIBLE WAVEGUIDE - Rectangular and Double Ridge	
90 degree Hybrid 3dB	4	Flex, Flex/Twist and Armored Flex	7
COUPLERS - Single and Dual		GASKETS - Conductive and Non Conductive	13
Directional (50W)	5	HORNS - ANTENNAS - Rectangular and Double Ridge	
High Power (200W, 600W, 900W, 1400W)	5	Standard Gain & Wide Band	8
DC BLOCKS		QUICK DISCONNECT - Rectangular and Double Ridge	13
Inner, Outer, Inner/Outer (SMA or N)	5	PRESSURIZING SECTIONS & INLETS	13
DIVIDERS, POWER		POWER SAMPLERS - Rectangular and Double Ridge	10
2, 4, 8 Way, 30W, SMA or N	4	STRAIGHT SECTIONS - Rectangular and Double Ridge	7
90 degree Hybrid 3dB	4	TERMINATIONS - Rectangular and Double Ridge	
LINE STRETCHERS - DC-26.5GHz	1	Short, Low [Precision], Medium, Hi Power, Water Cooled . . .	11
NOISE GENERATORS - 0.10-40.0GHz	6	Very Hi Power Double Ridge Models	12
PHASE SHIFTERS, VARIABLE & LINE STRETCHERS		WINDOWS - Rectangular and Double Ridge	10
Broadband and SatCom Bands (DC - 40GHz)	1	Standard [Teflon- Fiberglass] & Vacuum [Kapton]	10
Motor Driven	1	Ka-BAND SATCOM COMPONENTS	14
SWITCHES	6	SPACE QUALIFIED, FLIGHT and VACUUM CHAMBER COMPONENTS . . .	15
TERMINATIONS		CUSTOM PRODUCTS - Waveguide & Coax	15 & 16
DC - 40GHz	5		

INDEX

CLICK FOR COAXIAL COMPONENTS

CLICK FOR WAVEGUIDE COMPONENTS

Select Product Type from Menu then Click for Detailed Specifications, Data sheets, & Drawings

Freq GHz	Imp. dB	VSWR max.	In. max.	IL	Amp Bat (+/- Deg)	Phase Bat (+/- Deg)	Model No.	Outline Drawing
0.5 - 1.0	22	1.25	1.15	0.40	0.2	2.0	P212	Fig 1
1.0 - 2.0	20	1.25	1.15	0.35	0.2	2.0	P213	Fig 2
2.0 - 4.0	20	1.30	0.40	0.2	0.2	2.0	P214	Fig 3
4.0 - 8.0	30	1.35	1.25	0.50	0.2	3.0	P215	Fig 3
8.0 - 12.4	30	1.35	1.30	0.50	0.2	2.0	P216	Fig 4
12.0 - 18.0	18	1.40	1.35	0.60	0.3	6.0	P217	Fig 4
14.0 - 21.0	15	1.70	1.70	0.60	0.2	8.0	P218	Dwg

WG Size	Freq (GHz)	Model No. *	Class	Power (W)	VSWR (max)	Imp. (dB)	Phase (Deg)	Outline Drawing
WR284	2.00 - 3.95	284-25P4-A	SMA female	1.15	50	3	0.15	Dwg
WR228	2.30 - 4.30	228-25P4-B	SMA female	1.15	50	3	0.16	Dwg
WR187	3.95 - 5.85	187-25P4-A	SMA female	1.15	50	3	0.17	Dwg
WR150	4.95 - 7.40	150-25P4-B	SMA female	1.15	50	3	0.18	Dwg
WR137	5.85 - 8.30	137-25P4-B	SMA female	1.15	50	3	0.20	Dwg
WR112	7.20 - 10.6	112-25P4-A	SMA female	1.15	50	3	0.22	Dwg
WR102	7.90 - 11.8	102-25P4-A	SMA female	1.15	50	3	0.22	Dwg
WR90	8.20 - 12.4	90-25P4-A	SMA female	1.15	50	3	0.23	Dwg
WR75	10.0 - 15.0	75-25P4-B	SMA female	1.15	50	3	0.25	Dwg
WR62	12.4 - 18.0	62-25P4-B	SMA female	1.15	50	3	0.27	Dwg
WR51	15.0 - 22.0	51-25P4-B	SMA female	1.15	50	3	0.29	Dwg
WR42	18.0 - 26.0	42-25P4-B	Type K female	1.15	50	3	0.30	Dwg
WR34	22.0 - 33.0	34-25P4-B	Type K female (2.5mm)	1.15	50	3	0.30	Dwg
WR28	26.0 - 40.0	28-25P4-B	Type K female (2.5mm)	1.15	10	3	0.30	Dwg

CLICK FOR DRAWING

CLICK FOR DRAWING

SIZE	A	B	C	D	E	F
1	1.24	1.38	0.62	0.62	1.15	0.50
2	0.82	1.30	0.48	0.48	1.07	0.50
3	0.62	0.95	0.48	0.48	0.81	0.50
4	0.79	0.94	0.39	0.39	0.81	0.50
5	0.88	1.01	0.39	0.39	1.01	0.50
6	1.10	1.32	0.39	0.39	1.10	0.50
7	1.01	1.02	0.40	0.40	1.00	0.40
8	1.02	1.00	0.75	0.87	0.95	0.40
9	1.00	1.00	1.00	1.00	1.00	0.50
10	1.00	1.00	0.50	0.50	0.84	0.50
11	0.94	1.04	1.00	1.00	0.75	0.50

SIZE	A	B	C	D	E	F
1	1.24	1.38	0.62	0.62	1.15	0.50
2	0.82	1.30	0.48	0.48	1.07	0.50
3	0.62	0.95	0.48	0.48	0.81	0.50
4	0.79	0.94	0.39	0.39	0.81	0.50
5	0.88	1.01	0.39	0.39	1.01	0.50
6	1.10	1.32	0.39	0.39	1.10	0.50
7	1.01	1.02	0.40	0.40	1.00	0.40
8	1.02	1.00	0.75	0.87	0.95	0.40
9	1.00	1.00	1.00	1.00	1.00	0.50
10	1.00	1.00	0.50	0.50	0.84	0.50
11	0.94	1.04	1.00	1.00	0.75	0.50

PHASE SHIFTERS

Mechanical Adjustment with Screw Driver Shaft and Lock.
For Digital Counting Dial add "D" suffix to the Model Number
Phase Shift is linear with frequency and continuously variable.

RF Power: 100 Watt Average
3 KW Peak
RF Connectors: SMA Female or
Type N Female



P1400 and P2400 series

Standard Size
3.75" X 2" X 1"

Model No.* (SMA)	Model No.* (Type N)	Freq (GHz)	Phase Adjust (min)	I.L. (dB max)	VSWR (max)
P1403	P2403	DC-2.3	30°/GHz	0.5	1.5
P1404	P2404	DC-4.3	30°/GHz	0.5	1.5
P1405	P2405	DC-8.3	30°/GHz	0.6	1.5
P1406	P2406	DC-12.7	30°/GHz	0.7	1.5
P1407	P2407	DC-18.6	30°/GHz	1.0	1.6
P1408	P2408	DC-26.5	30°/GHz	1.5	2.0
P1408-360	N/A	18.0-26.5	0°-360°	1.5	1.8
P1409-360	N/A	18.0-40.0	0°-360°	2.5	2.0

P1500 and P2500 series

Standard Size
5.5" X 2" X 1"

Model No.* (SMA)	Model No.* (Type N)	Freq (GHz)	Phase Adjust (min)	I.L. (dB max)	VSWR (max)
P1503	P2503	DC-2.3	60°/GHz	0.5	1.5
P1504	P2504	DC-4.3	60°/GHz	0.5	1.5
P1505	P2505	DC-8.2	60°/GHz	0.6	1.5
P1506	P2506	DC-12.7	60°/GHz	0.7	1.5
P1507	P2507	DC-18.6	60°/GHz	1.0	1.6
P1508	P2508	18-26.0	60°/GHz	1.5	2.0

P1600 and P2600 series

Standard Size
7" X 2" X 1"

Model No.* (SMA)	Model No.* (Type N)	Freq (GHz)	Phase Adjust (min)	I.L. (dB max)	VSWR (max)
P1603	P2603	DC-2.3	90°/GHz	0.5	1.5
P1604	P2604	DC-4.3	90°/GHz	0.5	1.5
P1605	P2605	DC-8.2	90°/GHz	0.6	1.5
P1606	P2606	DC-12.7	90°/GHz	0.7	1.5
P1607	P2607	DC-18.6	90°/GHz	1.0	1.6

* For a Digital Counting Dial add "D" suffix to model number

series P1210, P2210, P1100 and P2100

Standard Size
180° 12" X 2" X 1"
360° 24" X 3" X 1.2"

Model No.* (SMA)	Model No.* (Type N)	Freq (GHz)	Phase Adjust (min)	I.L. (dB max)	VSWR (max)
P1213	P2213	DC-2.3	180°/GHz	0.6	1.3
P1214	P2214	DC-4.3	180°/GHz	0.7	1.5
P1102	P2102	DC-1.0	360°/GHz	0.5	1.3
P1103	P2103	DC-2.5	360°/GHz	0.8	1.5

LINE STRETCHERS

Locking Device Included
Smooth Continuous Phase Change
Light Weight Aluminum Housing
50 Ohm impedance
Operating Temperature Range: -54°C to +115°C
SMA and Type N Connectors



Freq (GHz)	VSWR (max)	Min. Phase Adjust	I.L. (dB Max)	Model No. (SMA)	Model No. (Type N)
DC-2.3	1.25	15°/GHz	0.2	P1913	P2913
DC-4.3	1.30	15°/GHz	0.25	P1914	P2914
DC-8.2	1.40	15°/GHz	0.30	P1915	P2915
DC-12.7	1.50	15°/GHz	0.5	P1916	P2916
DC-18.6	1.50	15°/GHz	0.6	P1917	P2917
DC-26.5	1.60	15°/GHz	0.8	P1918	N/A

Phase Shifter Drive Options



Standard Type



Digital Counting Dial (-D)



Direct Reading (-DRE)



Motor Drive (-28) OR SM24

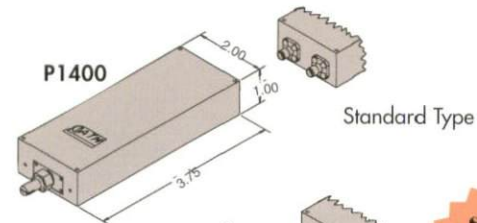

P1400

Standard Type

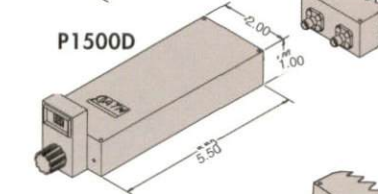

P1500D

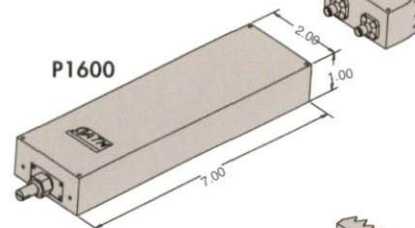

P1600

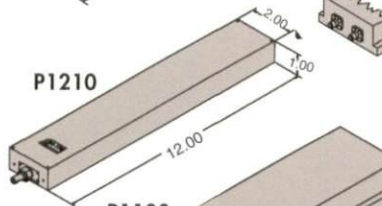

P1210

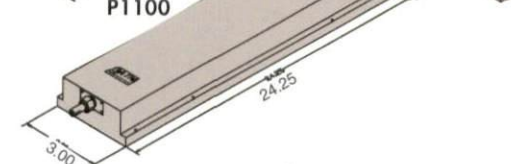

P1100

See ATM
Website
For
Additional
Models

Phase Shifter Drive Options

Standard Models are supplied with lock nut & Knob
For Digital Counting Dial add "D" suffix to Model number
For Direct Reading Dial add "DRE" suffix to Model number
For 28 Volt Motor Driver add -28 to the Model number
For Stepper Motor add -SM24 to the model number

CONTINUOUSLY VARIABLE ATTENUATORS

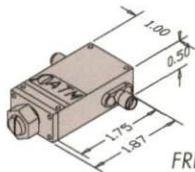

06 SERIES VARIABLE ATTENUATORS

FREQUENCY FLAT MODELS

Freq (GHz)	Atten Range (dB)	Flatness (+/- db)	Model No.
2.0-4.0	10	1.5	AF064-10
3.6-6.5	10	0.8	AF065C-10
5.8-6.5	20	0.5	AF06C2-20
*5.85-14.5	20	0.5/B	AF06CK-20
4.0-8.0	10	2.0	AF065-10
7.2-8.4	20	1.0	AF065X-20
8.0-12.4	10	1.0	AF066-10
10.7-12.7	20	0.8	AF066X-20
10.7-14.5	20	1.5	AF066K-20
13.0-14.5	30	0.5	AF067K-30
12.4-18.0	10	1.0	AF067-10
17.0-18.6	20	1.0	AF067J-20
8.0-18.0	20	1.8	AF066H-20
14.0-26.0	20	1.0	AF068-20
26.5-40	30	1.8	AF069-30

LEVEL ADJUST MODELS

Freq (GHz)	Atten Range (dB)	Flatness (+/- db)	Model No.
2.0-4.2	10	N/A	AV064-10
4.0-8.0	20	N/A	AV065-20
7.9-12.7	30	N/A	AV066-30
11.7-18.0	30	N/A	AV067-30
14.0-26.5	20	N/A	AV068-20
26.5-40	20	N/A	AV069-20

MULTIBAND MODELS

Freq (GHz)	Atten Range (dB)	Flatness (+/- db)	Model No.
2.0-8.0	10	N/A	AV064F-10
4.0-18.0	10	N/A	AV065H-10
6.0-18.0	30	N/A	AV066H-30
18.0-40	20	N/A	AV068Q-20

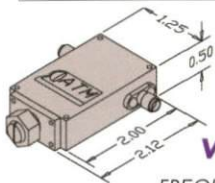

07 SERIES VARIABLE ATTENUATORS

FREQUENCY FLAT MODELS

Freq (GHz)	Atten Range (dB)	Flatness (+/- db)	Model No.
2.0-4.0	10	1.5	AF074-10
3.6-6.5	20	0.8	AF075C-20
3.6-4.3	20	0.5	AF075C1-20
5.8-6.5	20	0.5	AF075C2-20
*5.85-14.5	20	0.5/B	AF07CK-20
4.0-8.0	10	2.0	AF075-10
7.2-8.4	20	1.0	AF075X-20
7.9-8.4	20	0.5	AF076X2-20
8.0-12.4	10	1.0	AF076-10
10.7-12.7	20	0.8	AF076X-20
10.7-14.5	20	1.5	AF076K-20
12.4-18.0	10	1.0	AF077-10
17.0-18.6	20	1.0	AF077J-20
8.0-18.0	20	1.5	AF076H-20

LEVEL ADJUST MODELS

Freq (GHz)	Atten Range (dB)	Flatness (+/- db)	Model No.
1.0-2.0	10	N/A	AV073-10
1.5-2.0	15	N/A	AV073-15
2.0-4.0	20	N/A	AV074-20
2.0-8.0	20	N/A	AV074F-20
3.6-4.3	30	N/A	AV075C1-30
4.0-8.0	30	N/A	AV075-30
4.0-12.4	30	N/A	AV075G-30
8.0-12.4	40	N/A	AV076-40
8.0-18.0	40	N/A	AV076H-40

* Triband C, X, Ku

Attenuator Drive Options



Motor Drive (-28 or -SM24)



Knob Control



Turns Counting Dial



Direct Reading (calibrated in dB)

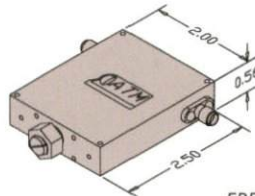

08 SERIES

FREQUENCY FLAT MODELS

Freq (GHz)	Atten Range (dB)	Flatness (+/- db)	Model No.
0.7-0.8	10	0.75	AF082L2-10
0.8-1.0	15	1.5	AF082L1-15
0.8-1.0	20	1.5	AF082L1-20
0.95-1.45	15	1.7	AF083L1-15
1.5-2.0	20	1.5	AF083L2-20
2.0-4.0	20	1.5	AF084-20
2.8-6.5	20	1.5	AF084F-20
3.4-4.2	20	1.0	AF085C3-20
3.6-6.5	30	1.2	AF085C-30
3.6-4.3	30	0.7	AF085C1-30
5.8-6.5	30	0.7	AF085C2-30
4.0-8.0	20	1.0	AF085-20
7.2-8.4	30	0.7	AF085X-30
8.0-12.4	20	1.0	AF086-20
10.7-12.7	30	1.0	AF086X-30
10.7-14.5	30	1.5	AF086K-30
12.4-18.0	20	1.0	AF087-20

LEVEL ADJUST MODELS

Freq (GHz)	Atten Range (dB)	Flatness (+/- db)	Model No.
0.7-1.0	10	N/A	AV082-10
0.8-1.6	15	N/A	AV083L-15
0.8-2.0	20	N/A	AV083L-20
1.0-2.0	20	N/A	AV083-20
2.0-4.2	20	N/A	AV084-20
4.0-8.0	30	N/A	AV085-30
7.9-12.7	30	N/A	AV086-30
11.7-18.0	30	N/A	AV087-30

MULTIBAND MODELS

Freq (GHz)	Atten Range (dB)	Flatness (+/- db)	Model No.
0.7-2.0	10	N/A	AV082D-10
1.0-4.0	20	N/A	AV083E-20
1.0-8.0	30	N/A	AV083F-30
2.0-18.0	10	N/A	AV084H-10
4.0-18.0	20	N/A	AV085H-20
6.0-18.0	60	N/A	AV086H-60

GENERAL SPECIFICATIONS FOR ALL UNITS

- RF CONN: SMA female (Type N also)
- INS LOSS: 0.5dB max
- VSWR: 1.5 max
- RF POWER*: 5 W avg, 3 Kw peak
- ATTEN RGE: Many other models to 60dB

*Higher Power Models Available - Contact Factory

ATTENUATOR DRIVE OPTIONS

Our Standard is a Screw Driver Shaft with a Lock Nut
The Part Number begins with AVO or AFO

For a **Knob Control Option** change the AVO or the AFO in the P/N to AV9 or AF9

Example: AF064-10 = AF964-10

For a **Turns Counting Dial Option** use AV8 or AF8

For a **Direct Reading Tape Drive Option** use AF7 for Full Frequency Range Calibration or AV7 for Single Frequency Calibration
(Specify Spot Frequency with Order)

For **28 Volt Motor Drive** add -28 to the Model Number

For **Stepper Motor Drive** add -SM24 to the Model Number

HIGH POWER VARIABLE ATTENUATORS

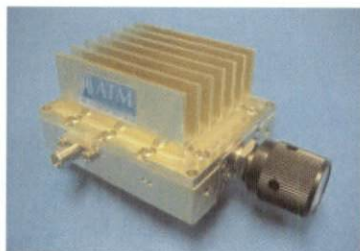

AH50V Series

50 WATTS*

RF CONN: SMA female
INS LOSS: 0.5dB max
VSWR: 1.5 max
RF POWER: 50 W avg
5 Kw peak

*Up to 250 Watts Available

Freq. (GHz)	Atten. Range (dB)	Flatness (+/- dB)	Model No.
0.5 - 1.0	6	N/A	AH50V082-6
0.8 - 1.6	10	N/A	AH50V083L-10
0.9 - 1.75	10	N/A	AH50V083L1-10
1.0 - 2.0	10	N/A	AH50V083-10
2.0 - 4.2	10	N/A	AH50V084-10
4.0 - 8.0	10	N/A	AH50V085-10
7.9 - 12.7	10	N/A	AH50V086-10
11.7 - 18.0	10	N/A	AH50V087-10

For 30W change AH50 to AH30

DC - 1 GHz VARIABLE ATTENUATORS

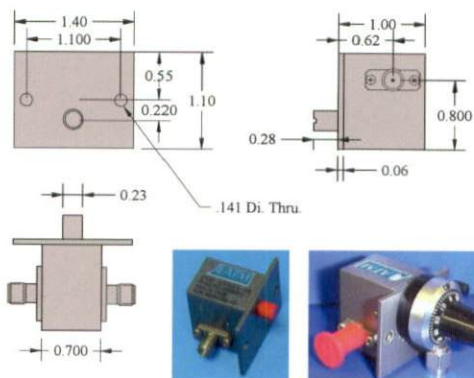

Standard Model

Dial Option*

AF03 Series

*Multi-Turn, SMA Connectors, Low Insertion Loss

Freq (MHz)	Atten (dB)	I.L. (dB max)	Flatness (+/- dB)	VSWR (max)	Model No. (50 Ohm)	Model No. (75 Ohm)
DC-100	0-15	0.5	0.5	1.8	AF030-15	AF030-15/75
DC-200	0-15	0.5	0.5	1.8	AF031-15	AF031-15/75
DC-500	0-15	0.5	1.0	1.8	AF032-15	AF032-15/75
DC-1000	0-15	1.0	1.5	2.0	AF033-15	N/A

AF02 SERIES

DC-100	0-15	0.5	0.5	1.8	AF020-15	N/A
DC-200	0-15	0.5	0.5	1.8	AF021-15	N/A
DC-500	0-15	0.5	1.0	1.8	AF022-15	N/A
DC-1000	0-15	1.0	1.5	1.8	AF023-15	N/A

*For Turns Counting Dial change P/N from AF0 to AF8



AF02 Series

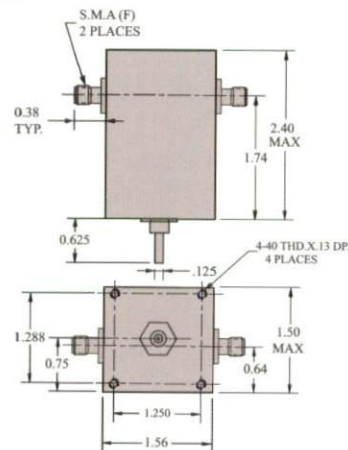

AF04 & AF05 Series

*Multi-Turn, SMA Connectors, Low Insertion Loss

Freq (MHz)	Atten (dB)	I.L. (dB max)	Flatness (+/- dB)	VSWR (max)	Model No. (50 Ohm)	Model No. (75 Ohm)
DC-100	0-30	1.0	1.0	1.5	AF040-30	AF040-30/75
DC-200	0-30	1.0	1.5	1.5	AF041-30	AF041-30/75
DC-500	0-30	1.0	1.5	1.8	AF042-30	AF042-30/75
DC-1000	0-30	3.0	N/A	2.0	AV043-30	N/A





Single-Turn, SMA, Low Insertion Loss, w/Calibration Dial

DC-100	0-30	1.0	1.0	1.5	AF050-30	AF050-30/75
DC-200	0-30	1.0	1.5	1.5	AF051-30	AF051-30/75
DC-500	0-30	1.0	1.5	1.5	AF052-30	AF052-30/75

For Lock Capability Add L to Model No.

ROTARY STEP ATTENUATORS

See ATM Website for Dimensions & Models

Model No. AS013-10-1	Model No. AS013-60-10	Model No. AS013-70-10	Model No. AS113-50-1 Dual Concentric	Model No. AS113-110-1 Dual Concentric
				
Freq. Range: DC-2500 MHz Atten Range: 0-10 dB in 1 dB steps Attenuation Accuracy: DC-1100 MHz ±0.25dB max, 1100-2200 MHz ±0.5dB max, 2200-2500 MHz ±0.6dB max VSWR: DC-1100 MHz 1.25:1 max, 1100-2000 MHz 1.5:1 max Insertion Loss: DC-1100 MHz 0.5dB max, 1100-2000 MHz 0.5dB max	Freq. Range: DC-2200 MHz Atten Range: 0-60 dB in 10 dB steps Attenuation Accuracy: DC-500 MHz ±0.5dB or 1%, 500-1000 MHz ±0.5dB or 2%, 1000-2000 MHz ±0.5dB or 3% VSWR: DC-1000 MHz 1.2:1 max, 1000-2000 MHz 1.4:1 max Insertion Loss: DC-1000 MHz 0.3dB max, 1000-2000 MHz 0.5dB max	Freq. Range: DC-2500 MHz Atten Range: 0-70 dB in 10 dB steps Attenuation Accuracy: DC-500 MHz ±0.5dB or 1%, 500-1000 MHz ±0.5dB or 2%, 1000-2000 MHz ±0.5dB or 3% VSWR: DC-1000 MHz 1.2:1 max, 1000-2000 MHz 1.4:1 max, 2000-2500 MHz 1.5:1 max Insertion Loss: DC-1000 MHz 0.3dB max, 1000-2000 MHz 0.5dB max, 2000-2500 MHz 0.6dB max	Freq. Range: DC-2500 MHz Atten Range: 0-50 dB in 1 dB steps Attenuation Accuracy: DC-500 MHz ±0.2dB or 1%, 500-1000 MHz ±0.3dB or 3%, 1000-2000 MHz ±0.4dB or 3% VSWR: DC-500 MHz 1.2:1 max, 500-1000 MHz 1.4:1 max, 1000-2500 MHz 1.5:1 max Insertion Loss: DC-1000 MHz 0.5dB max, 1000-2500 MHz 1.0dB max	Freq. Range: DC-2200 MHz Atten Range: 0-110 dB in 1 dB steps Attenuation Accuracy: DC-500 MHz ±0.5dB or 1%, 500-2000 MHz ±0.5dB or 3% VSWR: DC-500 MHz 1.2:1 max, 500-1000 MHz 1.4:1 max, 1000-2000 MHz 1.5:1 max Insertion Loss: DC-1000 MHz 0.5dB max, 1000-2000 MHz 1.0dB max

See ATM Website for More Models and

2WAY - 4WAY - 8WAY Dimensions
POWER DIVIDERS & COMBINERS

- Stripline Construction
- Connectors SMA and Type N
- Compact and Lightweight
- RF Power 30 Watt with all ports matched
- Models to 40 GHz

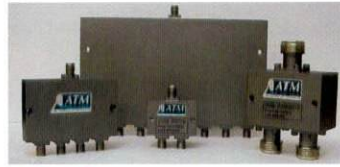

OCTAVE BAND - 2 WAY MODELS

Freq (GHz)	Isolation (dB min)	VSWR Max* In	VSWR Max* Out	Insertion Loss (dB)	Model No. (SMA)	Model No. (Type N)
0.5-1.0	22	1.25	1.15	0.40	P212	P222
1.0-2.0	20	1.25	1.15	0.35	P213	P223
2.0-4.0	20	1.30	1.20	0.40	P214	P224
4.0-8.0	20	1.35	1.25	0.50	P215	P225
8.0-12.4	20	1.35	1.30	0.50	P216	**
12.0-18.0	19	1.40	1.35	0.60	P217	**
14.0-21.0	15	1.70	1.70	0.60	P218	**

MULTIBAND MODELS 2 WAY MODELS

Freq (GHz)	Isolation (dB min)	VSWR Max* In	VSWR Max* Out	Insertion Loss (dB)	Model No. (SMA)	Model No. (Type N)
0.5-4.0	20	1.3	1.2	0.50	P212E	**
0.8-2.4	20	1.25	1.2	0.35	P212D	P222D
2.0-8.0	20	1.35	1.35	0.40	P214F	P224F
1.0-18.0	18	1.4	1.4	1.00	P213H	**
6.0-18	19	1.4	1.35	0.60	P215H	P225H
2.0-26.5	19	1.4	1.35	1.10	P2K8	**

SATCOM & SPECIAL BAND 2 WAY MODELS

Freq (GHz)	Isolation (dB min)	VSWR Max* In	VSWR Max* Out	Insertion Loss (dB)	Model No. (SMA)	Model No. (Type N)
0.85-1.65	22	1.25	1.20	0.40	P213L	P223L
3.65-6.5	20	1.35	1.25	0.40	P215C	P225C
3.65-4.3	22	1.25	1.20	0.40	P215C1	P225C1
5.85-6.5	22	1.25	1.20	0.40	P215C2	P225C2
7.2-8.4	20	1.35	1.30	0.50	P215X	P225X
7.2-7.75	20	1.30	1.30	0.50	P215X1	P225X1
7.9-8.4	20	1.30	1.30	0.50	P215X2	P225X2
10.7-12.7	20	1.40	1.35	0.60	P216X-1	P226X-1
10.7-14.5	18	1.45	1.40	0.60	P216K-1	P226K-1
13.7-14.5	20	1.40	1.35	0.60	P217K-1	P227K-1

ULTRA WIDE BAND 2 WAY MODELS

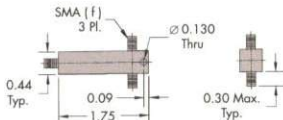

Freq (GHz)	Isolation (dB min)	VSWR Max* In	VSWR Max* Out	Insertion Loss (dB)	Model No. (SMA)	Model No. (Type N)
0.5-18		Specs In Table Below			—	P223HT
0.5-20		Specs In Table Below			P213HT	N/A

ULTRA WIDE BAND 2 WAY MODELS SPECS

Freq. Range (GHz)	Insertion Loss (dB Max)	Isolation (dB Min.)	VSWR In (Max.)	VSWR Out (Max.)	Phase Balance (Deg. Max)	Amplitude Balance (dB Max)	Input Power (W Max.)
0.5-1	0.70	6	2.00:1	2.00:1	1	0.20	10
1-1.5	0.50	10	1.70:1	1.50:1	1	0.20	10
1.5-2	0.50	15	1.60:1	1.40:1	1	0.20	10
2-4	0.40	20	1.50:1	1.30:1	1	0.20	10
4-8	0.50	17	1.50:1	1.40:1	1.5	0.20	10
8-15	0.80	15	1.70:1	1.50:1	2	0.30	10
15-16	0.80	15	1.70:1	1.60:1	3	0.30	10
16-18	0.90	14	1.80:1	1.90:1	4	0.40	10
18-20	1.10	7	2.00:1	2.00:1	4	0.40	10

SPECIAL 10.0 - 40.0 GHz 2 WAY MULTI - BAND UNIT

Model (No.)	Freq. (GHz)	Isolation (dB Min.)	VSWR Max (In)	VSWR Max (Out.)	Isolation (dB Min.)	Amplitude Balance (+/- dB)	Phase Balance (+/- deg)
P2K9A	10.0-18.0	18	1.6	1.5	1.5	0.6	6.0
	18.0-40.0	18	1.6	1.5	2.1	0.6	6.0



OCTAVE & WIDE BAND 4 WAY MODELS

Freq (GHz)	Isolation (dB min)	VSWR Max* In	VSWR Max* Out	Insertion Loss (dB)	Model No. (SMA)	Model No. (Type N)
0.5-1.0	22	1.45	1.30	0.90	P412	P422
1.0-2.0	20	1.40	1.25	0.80	P413	P423
2.0-4.0	20	1.35	1.35	0.60	P414	P424
4.0-8.0	20	1.45	1.35	0.60	P415	P425
7.0-12.4	18	1.45	1.35	0.80	P416	**
12.0-18.0	18	1.50	1.40	0.90	P417	**
0.5-4.0	15	1.50	1.40	1.00	P412E	**
2.0-8.0	15	1.60	1.40	2.00	P414F	P424F
2.0-18.0	15	1.60	1.40	2.00	P414H	**
6.0-18.0	18	1.60	1.40	0.90	P415H	**
14.0-21.0	16	1.60	1.60	1.50	P418	**

SATCOM & SPECIAL BAND 4 WAY MODELS

Freq (GHz)	Isolation (dB min)	VSWR Max* In	VSWR Max* Out	Insertion Loss (dB)	Model No. (SMA)	Model No. (Type N)
0.85-1.65	22	1.25	1.20	0.40	P413L	P423L
3.65-6.5	20	1.35	1.25	0.40	P415C	P425C
3.65-4.3	22	1.25	1.20	0.40	P415C1	P425C1
5.85-6.5	22	1.25	1.20	0.40	P415C2	P425C2
7.2-8.4	20	1.35	1.30	0.50	P415X	P425X
7.2-7.75	20	1.30	1.30	0.50	P415X1	P425X1
7.9-8.4	20	1.30	1.30	0.50	P415X2	P425X2
10.7-12.7	20	1.40	1.35	0.60	P416X-1	P426X-1
10.7-14.5	18	1.45	1.40	0.60	P416K-1	P426K-1
13.7-14.5	20	1.40	1.35	0.60	P417K-1	P427K-1
5.7-18.5	12	1.70	1.60	2.00	P415CJ	**

OCTAVE & WIDE BAND 8 WAY MODELS

Freq (GHz)	Isolation (dB min)	VSWR Max* In	VSWR Max* Out	Insertion Loss (dB)	Model No. (SMA)	Model No. (Type N)
0.5-1.0	18	1.45	1.30	0.90	P812	P822
1.0-2.0	18	1.45	1.35	0.80	P813	P823
2.0-4.0	18	1.45	1.35	0.80	P814	P824
4.0-8.0	17	1.45	1.40	1.0	P815	P825
8.0-12.4	16	1.60	1.50	1.4	P816	**
12.0-18.0	15	1.60	1.50	2.0	P817	**
2.0-18.0	13	1.70	1.70	3.0	P814H	**

SATCOM & SPECIAL BAND 8 WAY MODELS

Freq (GHz)	Isolation (dB min)	VSWR Max* In	VSWR Max* Out	Insertion Loss (dB)	Model No. (SMA)	Model No. (Type N)
0.85-1.65	18	1.45	1.40	0.8	P813L	P823L
3.65-6.5	17	1.45	1.45	0.8	P815C	P825C
3.65-4.3	18	1.40	1.40	0.8	P815C1	P825C1
5.85-6.5	18	1.45	1.40	0.8	P815C2	P825C2
7.2-8.4	16	1.45	1.40	0.9	P815X	P825X
7.2-7.75	16	1.45	1.40	0.9	P815X1	P825X1
7.9-8.4	16	1.45	1.40	0.9	P815X2	P825X2
10.7-12.7	17	1.45	1.40	1.0	P816X-1	P826X-1
10.7-14.5	17	1.45	1.40	1.0	P816K-1	P826K-1
13.7-14.5	17	1.45	1.40	1.0	P817K-1	P827K-1

* Type N Models are .05 higher in VSWR than SMA Models
**Type N Units available in narrower bands

90° HYBRID 3dB COUPLERS

- The Hybrid Directional Coupler splits power equally between its two output ports
- Two output ports are 90° out of phase with each other
- Construction is stripline in an aluminum housing

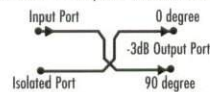

Phase Balance Typically: ±5°
RF Conn: SMA Female or Type N Female- 4 ports



OCTAVE BAND MODELS

RF Power 50W Avg 2kW peak

Freq (GHz)	VSWR (max)	ISO (dB min)	Coupling Limits (dB)	Model No. (SMA)	Model No. (Type N)
0.2-1.0	1.20	20	3.2±0.6	H911C	H921C
0.5-1.0	1.10	28	3.1±0.6	H912	H922
1.0-2.0	1.10	28	3.1±0.6	H913	H923
2.0-4.0	1.20	22	3.1±0.6	H914	N/A
2.6-5.2	1.25	20	3.1±0.6	H914K	N/A
4.0-8.0	1.25	18	3.2±0.7	H915	N/A
6.0-12.4	1.30	18	3.2±0.7	H916	N/A
7.5-16.0	1.40	15	3.4±0.9	H916H	N/A
12.0-18.0	1.45	15	3.4±1.0	H917	N/A

BROADBAND MODELS

RF Power 30W Avg 2kW peak

Freq (GHz)	VSWR (max)	ISO (dB min)	Coupling Limits (dB)	Model No. (SMA)	Model No. (Type N)
0.5-2.0	1.30	15	3.3±0.8	H912D	H922D
0.8-2.5	1.30	15	3.3±0.8	H912E	H922E
2.0-8.0	1.30	17	3.3±0.8	H914F	H924F
4.0-12.4	1.35	17	3.3±0.8	H915G	H925G
7.0-18.0	1.50	13	3.4±1.0	H915H	H925H



For a wide variety of Microwave Components



See ATM Website for Add'l Coupler Models & Dimensions

DIRECTIONAL COUPLERS

RF Power: 50W avg. 3 KW peak
Design: Stripline
Standard Coupling: 6, 10, 20, and 30dB
Coupling Flatness: ± 1.0 dB full band
RF Connectors: SMA and Type N.



OCTAVE BAND MODELS

Freq (GHz)	VSWR Thru	Max** Coup	Directivity (dB min)	I. L.† (dB)	Model No. (SMA)	Model No. (Type N)
0.43-1.0	1.10	1.10	25	0.2	C111L*	C211L*
0.5-1.0	1.10	1.10	25	0.2	C112*	C212*
1 - 2	1.10	1.10	25	0.2	C113*	C213*
2 - 4	1.15	1.15	22	0.2	C114*	C214*
2.6-5.2	1.25	1.25	20	0.2	C114F*	C214F*
4 - 8	1.25	1.25	20	0.25	C115*	C215*
7 -12.4	1.30	1.30	17	0.3	C116*	C216*
7.5-16	1.35	1.40	15	0.5	C116H*	C216H*
12.4-18	1.35	1.40	15	0.5	C117*	C217*
14-21	1.65	1.65	12	0.7	C118*	**

MULTIBAND MODELS

Freq. Rge (GHz)	VSWR Thru	Max** Coup	Directivity (dB min)	I. L.† (dB)	Model No. (SMA)	Model No. (Type N)
0.5-2.0	1.20	1.20	23	0.4	C122D*	C222D*
0.6-4.0	1.20	1.20	23	0.4	C122E*	C222E*
0.8-2.7	1.20	1.20	23	0.4	C122L*	C222L*
1 - 4	1.20	1.20	23	0.4	C123E*	C223E*
2 - 8	1.25	1.25	20	0.4	C124F*	C224F*
4 - 12.4	1.25	1.25	17	0.5	C125G*	C225G*
6 - 18	1.35	1.35	15	0.7	C126H*	C226H*
1 - 18	1.40	1.50	15	0.9	C123H*	C223H*
4 - 18	1.35	1.40	18	0.6	C125H*	C225H*
18-40	1.90	1.90	12	1.4	C128K*	N/A

* Add coupling in dB. Example C115-20. † Insertion loss excludes coupling loss
** Type N models are spec .05 higher in VSWR than SMA models

50 Watt Dual Directional Couplers

RF Power: 50W avg. 3 KW peak
• Design: Stripline
• Standard Coupling: 10, 20, and 30dB*
(6dB and Other Values Available)
RF Connectors: SMA Female



Model No.	Freq. Rge (GHz)	Freq. Sens. \pm (dB)	Directivity (dB) max.*	Ins. Loss (dB) min.	VSWR max Main	Sec.
C132*	0.5-1.0	0.75	22	0.20	1.15	1.10
C133*	1.0-2.0	0.75	22	0.25	1.15	1.10
C134*	2.0-4.0	0.75	20	0.30	1.20	1.15
C134F*	2.6-5.2	0.75	18	0.20	1.30	1.25
C135*	4.0-8.0	0.75	18	0.25	1.35	1.25
C136*	7.0-12.4	0.50	16	0.30	1.35	1.30
C136H*	8.0-16.0	0.75	15	0.50	1.40	1.40
C137*	12.4-18.0	0.60	15	0.50	1.40	1.40

* Coupling value 10, 20, 30dB (Example: C132-20)

FIXED ATTENUATORS

Standard Values are 3, 6, 10 and 20dB
Other Values, 1 thru 30dB, are available



Freq Rge (GHz)	RF Power (CW)	VSWR (max)	Model No. (SMA M/F)	Model No. (Type N M/F)
DC-6.5	2	1.2	3105-dB	2205-dB
DC-12.4	2	1.25	3106-dB	2206-dB
DC-18.0	2	1.35	3107-dB	2207-dB
DC-26.0	2	1.40	2108-dB*	N/A
DC-40.0	2	1.4	2109-dB*	N/A
DC-6.5	5	1.2	0515-dB	0525-dB
DC-18.0	5	1.35	0517-dB	0527-dB
DC-6.5	10	1.25	1015-dB	1025-dB
DC-18.0	10	1.40	1017-dB	1027-dB
DC-6.5	25	1.20	2515-dB	2525-dB
DC-18.0	25	1.4	2517-dB	2527-dB
DC-6.5	50	1.3	5015-dB	5025-dB
DC-18.0	50	1.45	5017-dB	5027-dB

*Unit available with 2.9mm connector only.

HIGH POWER DIRECTIONAL COUPLERS

RF Power: 200 Watt average
3 KW peak
Design: Stripline
Standard Coupling: 10, 20, and 30dB
Coupling Flatness: ± 1.0 dB full band
RF Connectors: SMA and Type N.



OCTAVE BAND MODELS

Freq (GHz)	VSWR Thru	Max** Coup	Directivity (dB min)	I. L.† (dB)	Model No. (SMA)	Model No. (Type N)
0.5-1.0	1.10	1.10	25	0.2	CH112*	CH212*
1 - 2	1.10	1.10	25	0.2	CH113*	CH213*
2 - 4	1.15	1.15	22	0.2	CH114*	CH214*
2.6-5.2	1.25	1.25	20	0.2	CH114F*	CH214F*
4 - 8	1.25	1.25	20	0.25	CH115*	CH215*
4-18	1.40	1.35	12	0.5	CH125H-35	CH225H-35

* Add coupling in dB. Example CH115-20. † Insertion loss excludes coupling loss
** Type N models are spec .05 higher in VSWR than SMA models

600W to 1400W High Power Directional Couplers

- Airline Design, Single and Dual Couplers
- Couplers 30dB, 40dB, 50dB, Standard
- Coupling Output SMA-f Standard
- In/Out Connectors, RF Power
- N-f, std 600W avg. 10KW peak
- SC-f, option 900W avg. 10KW peak
- 7/16-f, option 1400W avg. 10KW peak



Model No.	Freq. Rge (GHz)	Freq. Sens. \pm (dB)	Directivity (dB) min.	Ins. Loss dB Excluding Coupled Power	VSWR max True	Main	Sec.
CHP223L*	0.86-1.7	1.0	23	0.15	0.20	1.20	1.30
CHP223*	1.0-2.0	1.0	23	0.15	0.20	1.20	1.30
CHP224*	2.0-4.0	1.0	23	0.15	0.20	1.25	1.30
CHP225*	4.0-8.0	1.0	21	0.15	0.20	1.25	1.30
CHP223E*	1.0-4.0	1.0	22	0.15	0.20	1.20	1.30
CHP222L*	0.8-4.2	1.2	20	0.15	0.20	1.20	1.30
CHP224F*	2.0-8.0	1.0	21	0.15	0.20	1.25	1.30

* Coupling value 30, 40, 50dB (Example: CHP223L-30)

DC BLOCKS

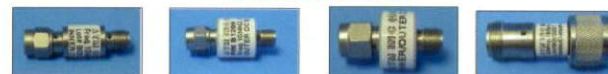

B220H SMA (Inner)
B120J SMA (Outer)
B320K 2.9mm (In/Out)
B350H Type N (In/Out)

Specifications

VSWR: 1.35 max
1.45 for 40 GHz Models
Blocking Volt: 200 volts
Ins. Loss: 0.5 dB max

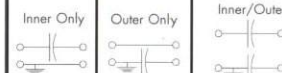

Frequency	Connect	Model No.		
10 MHz - 18.0 GHz	SMA	B220H	B120H	B320H
	N	B250H	B150H	B350H
10 MHz - 26.5 GHz	2.9mm	B220J	B120J	B320J
10 MHz - 40 GHz	2.9mm	B220K	B120K	B320K
10 MHz - 50 GHz	2.4mm	B2240Q	B1240Q	B3240Q

See ATM Website For Full Specs & Drawings

COAXIAL TERMINATIONS



Freq. (GHz)	RF Power (watts)	VSWR (max)	Model No. (SMA-m)	Model No. (Type N-m)
DC-20.0	1	1.15	T0117	N/A
DC-20.0	2	1.25	T0217	T0227
DC-40.0	2	1.20	T02K9*	N/A
DC-8.0	5	1.20	T0515	T0525
DC-18.0	5	1.25	T0517	T0527
DC-18.0	10	1.35	T1017	T1027
DC-8.0	25	1.20	T2515	T2525
DC-18.0	25	1.35	T2517	T2527
DC-8.0	50	1.25	T5015	T5025
DC-18.0	50	1.25	T5017	T5027
DC-4.0	100	1.35	T10014	T10024
3.0-12.4	500	1.30	N/A	T50025G

*Unit available with 2.9mm connector only.

COAXIAL COMPONENTS

FLEXIBLE MICROWAVE LOW LOSS CABLE ASSEMBLIES, RAW CABLES AND CONNECTORS



Model No.	CF-100	CF-135	CF-160	CF-210	CF-300	CF-500
Freq. Operation	DC-62GHz	DC-43GHz	DC-35GHz	DC-30GHz	DC-18GHz	DC-11GHz
Size O.D. (Inches)	0.110	0.145	0.170	0.220	0.310	0.500
Impedance (ohms)	50	50	50	50	50	50Dielectric Type
Dielectric Type	SPTFE	EPTFE	SPTFE	EPTFE	EPTFE	PE
Capacitance (pF/ft)	29	24	29	24	24	23
Time Delay (ns/ft)	1.4	1.2	1.4	1.2	1.2	1.15
Velocity (%)	70	84	70	84	84	85
RF Leakage	>100dB to 18 GHz	>100dB to 18GHz >80dB to 40 GHz	>100dB to 18GHz	>100dB to 18GHz	>100dB to 18GHz	>100dB to 11GHz
Cut Off Frequency (GHz)	62	43	35	30	18	11
Weight (lbs/100ft)	1.9	3	6.5	7	12.5	15
Min Bend Radius (in)	0.25	0.5	0.75	1.0	2.0	3.0
Temp Range (min/max °C)	-65°/+200°	-65°/+200°	-65° to +200° C	-65°/+200°	-65°/+200°	-65°/+90°
Total Cable assembly * loss for 12" Assembly @ 10	0.75	0.48	0.61	0.46	0.39	0.35

Cable Assembly CF

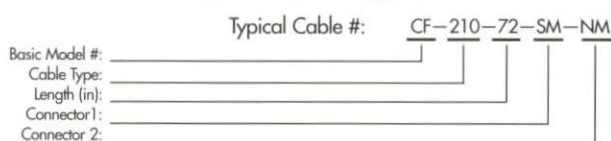

Raw Cable CFR



Connectors

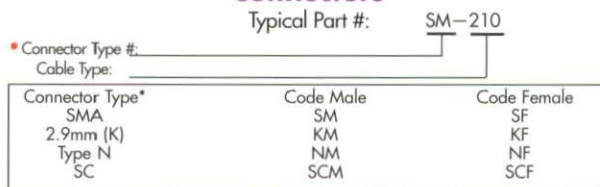

* See ATM Website for More Connector Options

PIN DIODE SOLID STATE SWITCHES

Frequency: 0.5-18.0 GHz Peak Power: 75 watt, 1us pulse width
 RF Power: +10 dBm spec compliant +30 dBm survival (OW)

See Web for SP2T, SP3T, SP4T



Type: SP1T Reflective			Model No. S1517D				
Ins. Loss	Isolation Loss	VSWR Input/Output	Switching Speed (off/on)	Switching Speed (on/off)	Control Logic TTL	Power DC	Oper. Temp.
2.5 dB	0.5-2GHz 2-18 GHz 37dB 80dB	1.8:1 max	20ns max (50% TTL to 90% RF)	20ns max (50% TTL to 90% RF)	1 line, logic 1 path on	±1.5VDC to at 40 mA	-45°C to +85°C

CIRCULATOR / ISOLATOR



Frequency	ISO (dB)		Loss(dB)		VSWR		Power (Watts)		Model Number	
	Typ.	Min.	Typ.	Max.	Typ.	Max.	Avg.	Peak	Circulator	Isolator
1.0 - 2.0	20	15	0.35	0.50	1.25	1.35	2	20	ATc1-2	ATI1-2
2.0 - 4.0	20	18	0.40	0.50	1.25	1.30	2	20	ATc2-4	ATI2-4
2.6 - 5.2	20	18	0.40	0.50	1.25	1.30	2	20	ATc2.6-5.2	ATI2.6-5.2
3.0 - 6.0	21	19	0.35	0.40	1.25	1.30	2	20	ATc3-6	ATI3-6
4.0 - 8.0	22	20	0.35	0.40	1.18	1.25	2	20	ATc4-8	ATI4-8
5.0 - 10.0	16	15	0.90	1.00	1.40	1.45	2	20	ATc5-10	ATI5-10
6.0 - 12.4	19	17	0.50	0.60	1.30	1.35	2	20	ATc6-12	ATI6-12
6.0 - 18.0	15	14	0.90	1.00	1.45	1.50	2	20	ATc6-18	ATI6-18
8.0 - 12.4	22	20	0.35	0.40	1.18	1.25	2	0	ATc8-12.4	ATI8-12.4
8.0 - 18.0	17	16	0.70	0.80	1.40	1.45	2	30	ATc8-18	ATI8-18
18.0-26.5	20	18	0.70	0.80	1.35	1.40	2	30	ATc18-26.5	ATI18-26.5
26.5 - 40.0	15	14	0.80	1.00	1.45	1.50	2	30	ATc26.5-40	ATI26.5-40

See ATM Website for ranges 0.3 GHz to 40 GHz & Waveguide Models

Note: ATM Standard Parts come with SMA Female Connectors In and Out

For other connector configurations see web

*Power specs are for Isolators. Circulators can handle up to 10x's the average power

**2.9 mm (f) Connectors Used

15.5db ENR Noise Sources

Housing: .75"X.75"X3.4"(Max).
 DC Input: BNC (F) Conn.
 RF Output: SMA (M) or type 2.9mm(M)



Model No.	Freq (GHz)	Noise Output (ENR -dB)	VSWR(max) ON/OFF	Calibration Frequencies	Package Code
NX1502R	0.01-1.60	15.5 +/-1.0	1.20:1	10, 70, 140 MHz	R
NX1512X	1-2	15.5 +/-0.5	1.20:1	0.5 GHz Increments	X
NX1524X	2-4	15.5 +/-0.5	1.20:1	1.0 GHz Increments	X
NX1548X	4-8	15.5 +/-0.5	1.20:1	1.0 GHz Increments	X
NX15812X	8-12	15.5 +/-0.5	1.35:1	1.0 GHz Increments	X
NX151218X	12-18	15.5 +/-0.5	1.35:1	1.0 GHz Increments	X
NX151826T	18-26.5	15.5 +/-1.0	1.35:1	1.0 GHz Increments	T
NX15238T	2-0.38.0	15.5 +/-2.0	1.35:1	1.0 GHz Increments	T
NX152640T	26.5-40.0	15.5 +/-2.0	1.35:1	1.0 GHz Increments	T

*X or T package may be selected for either series by changing the suffix of the model number. Example: NX1512X=NX1512Y

High Output ENR Noise Sources

Housing: .5"X.5"X2.84"(Max).
 DC Input: SMA (F) Conn.
 RF Output: SMA or type 2.9 mm(M)



Model No.	Freq (GHz)	Noise Output (ENR dB)	Noise Flatness (dB)	Calibration Frequencies	Package Code
NX32025	0.01-1.6	30-36	+/- 2.0	10, 70, 140 MHz	S
NX3212Y	1-2	30-35	+/- 1.0	0.5 GHz Increments	Y
NX3224Y	2-4	30-35	+/- 1.0	1.0 GHz Increments	Y
NX3248Y	4-8	30-35	+/- 1.0	1.0 GHz Increments	Y
NX32812Y	8-12	28-33	+/- 1.0	1.0 GHz Increments	Y
NX321218Y	12-18	26-32	+/- 1.0	1.0 GHz Increments	Y
NX231826V	18-26.5	23 +/-1.5	+/- 1.0	1.0 GHz Increments	V
NX23226V	2-26.5	23 +/-2.0	+/- 2.0	1.0 GHz Increments	V
NX322638V	26.5 - 38.0	22.0 +/- 1.5	+/- 1.0	1.0 GHz increments	V
NX322640V	26.5 - 40.0	22.0 +/- 1.5	+/- 1.0	1.0 GHz increments	V

*Y or V package may be selected for either series by changing the suffix of the model number. Example: NX3201Y=NX3201X

See ATM Website for More Connector Options

See ATM Website for Add'l Models & Dimensions



For a wide variety of Microwave Components



WAVEGUIDE ASSEMBLIES: STRAIGHT SECTIONS, BENDS, MITERS AND TWISTS

Bends of 30, 45, 60, 90 degrees available
 Mitered Bends available for tight bend requirements
 90 Degree Twists Clockwise are standard.
 Other Angles and Counter Clockwise Twists are available.

*Model Numbers are constructed as follows:
 WR#-Model#&Material-Length, Inches(Meters)-Flange-Flange
Example: 90° E BEND: 284-510A-8x8-6-6
 Material Code: A - Aluminum, B-Brass, C - Copper
 Flange Code: See tables below

See ATM Website for Add'l Waveguide Items

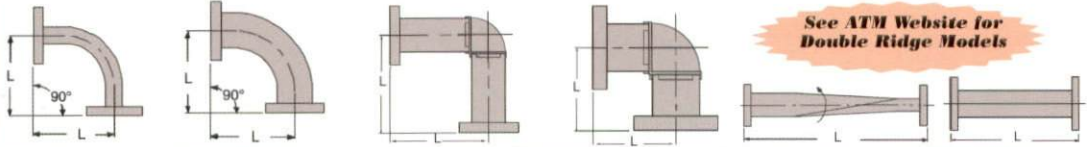
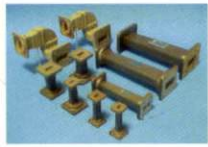

See ATM Website for Double Ridge Models

WG Size	Freq GHz	90 Degree E Bend	90 Degree H Bend	90 Degree E Miter Bend	90 Degree H Miter Bend	90 Degree Twist	Straight Sections
WR650	1.00 - 1.70	650-500A-10x10-2-2	650-510A-12x12-2-2	650-520A-4x4-2-2	650-530A-5x5-2-2	650-340A-24-2-2	650-120A-12-2-2
WR430	1.70 - 2.60	430-500A-8x8-2-2	430-510A-10x10-2-2	430-520A-3x3-2-2	430-530A-4x4-2-2	430-340A-16-2-2	430-120A-12-2-2
WR340	2.20 - 3.30	340-500A-8x8-2-2	340-510A-10x10-2-2	N/A	N/A	340-340A-15-2-2	340-120A-12-2-2
WR284	2.60 - 3.95	284-500A-6x6-6-6	284-510A-6x6-6-6	284-520A-3.75x3.75-6-6	284-530A-4x4-6-6	284-340A-12-6-6	284-120A-10-6-6
WR229	3.30 - 4.90	229-500B-4x4-2-2	229-510B-4x4-2-2	229-520B-2.21x2.21-2-2	229-530B-3X3-2-2	229-340B-12-2-2	229-120B-6-2-2
WR187	3.95 - 5.85	187-500A-3x3-6-6	187-510A-3x3-6-6	187-520A-1.87x1.87-6-6	187-530A-3X3-6-6	187-340A-8-6-6	187-120A-6-6-6
WR159	4.09 - 7.05	159-500B-2.5x2.5-2-2	159-510B-2.5x2.5-2-2	159-520B-1.75x1.75-2-2	159-530B-3X3-2-2	159-340B-6-2-2	159-120B-6-2-2
WR137	5.85 - 8.20	137-500B-2.5x2.5-2-2	137-510B-2.5x2.5-2-2	137-520B-1.82x1.82-2-2	137-530B-3X3-2-2	137-340B-6-2-2	137-120B-6-2-2
WR112	7.05 - 10.0	112-500B-2x2-6-6	112-510B-2x2-6-6	112-520B-1.6x1.6-6-6	112-530B-2x2-6-6	112-340B-6-6-6	112-120B-6-6-6
WR102	7.00 - 11.0	102-500A-2x2-6-6	102-510A-2x2-6-6	102-520A-1.47x1.47-6-6	102-530A-2x2-6-6	102-340A-6-6-6	102-120A-6-6-6
WR90	8.20 - 12.4	90-500A-2x2-6-6	90-510A-2x2-6-6	90-520A-1.34x1.34-6-6	90-530A-2x2-6-6	90-340A-5-6-6	90-120A-6-6-6
WR75	10.0 - 15.0	75-500B-1.75x1.75-6-6	75-510B-1.75x1.75-6-6	75-520B-1.16x1.16-6-6	75-530B-2x2-6-6	75-340B-4-6-6	75-120B-6-6-6
WR62	12.4 - 18.0	62-500B-1.75x1.75-6-6	62-510B-1.75x1.75-6-6	62-520B-.88x.88-6-6	62-530B-1x1-6-6	62-340B-4-6-6	62-120B-6-6-6
WR51	15.0 - 22.0	51-500B-1.5x1.5-6-6	51-510B-1.5x1.5-6-6	51-520B-.95x.95-6-6	51-530B-1x1-6-6	51-340B-4-6-6	51-120B-6-6-6
WR42	18.0 - 26.5	42-500B-1x1-6-6	42-510B-1x1-6-6	42-520B-.77x.77-6-6	42-530B-1x1-6-6	42-340B-3-6-6	42-120B-3-6-6
WR34	22.0 - 33.0	34-500B-1x1-6-6	34-510B-1x1-6-6	34-520B-.77x.77-6-6	34-530B-1x1-6-6	34-340B-3-6-6	34-120B-3-6-6
WR28	26.5 - 40.0	28-500B-1x1-6-6	28-510B-1x1-6-6	28-520B-.77x.77-6-6	28-530B-1x1-6-6	28-340B-3-6-6	28-120B-3-6-6
WR22	33.0-50.0	22-500B-1x1-6-6	22-510B-1x1-6-6	N/A	N/A	22-340B-3-6-6	22-120B-L-6-6

DOUBLE RIDGE W/G*

WRD250	2.6 - 7.8	N/A	N/A	250-520-4x4-C3-C3	250-530-4x4-C3-C3	250-340-L-C3-C3	250-120-L-C3-C3
WRD350	3.5 - 8.2	N/A	N/A	350-520-3x3-C3-C3	350-530-3x3-C3-C3	350-340-L-C3-C3	350-120-L-C3-C3
WRD475	4.75 - 11.0	N/A	N/A	475-520-2.5x2.5-C3-C3	475-530-2.5x2.5-C3-C3	475-340-L-C3-C3	475-120-L-C3-C3
WRD580	5.8 - 16.0	N/A	N/A	580-520-2x2-C3-C3	580-530-2x2-C3-C3	580-340-L-C3-C3	580-120-L-C3-C3
WRD650	6.5 - 18.0	N/A	N/A	650-520-2x2-C3-C3	650-530-2x2-C3-C3	650-340-L-C3-C3	650-120-L-C3-C3
WRD750	7.5 - 18.0	N/A	N/A	750-520-2x2-C3-C3	750-530-2x2-C3-C3	750-340-L-C3-C3	750-120-L-C3-C3
WRD180	18 - 18.0	N/A	N/A	180-520-1x1-C3-C3	180-530-1x1-C3-C3	180-340-L-C3-C3	180-120-L-C3-C3

FLEXIBLE WAVEGUIDE

Standard lengths are 1, 2, & 3 feet
 Neoprene Rubber Jacket is standard on Flexible-Twistable Waveguide
 Flexible Non-Twistable Waveguide is supplied without jacket



Rectangular Waveguide Flex

WG Size	Freq (GHz)	Flex-Twist* w/ Jacket	Flexible* No Jacket
WR 284	2.60 - 3.95	284-125-L-6-7	284-124-L-6-7
WR 229	3.30 - 4.90	229-125-L-1-1	229-124-L-1-1
WR 187	3.95 - 5.85	187-125-L-6-7	187-124-L-6-7
WR 159	4.90 - 7.05	159-125-L-1-1	159-124-L-1-1
WR 137	5.85 - 8.20	137-125-L-1-1	137-124-L-1-1
WR 112	7.05 - 10.0	112-125-L-6-7	112-124-L-6-7
WR 90	8.20 - 12.4	90-125-L-6-7	90-124-L-6-7
WR 75	10.0 - 15.0	75-125-L-6-7	75-124-L-6-7
WR 62	12.4 - 18.0	62-125-L-6-7	62-124-L-6-7
WR 51	15.0 - 22.0	51-125-L-6-7	51-124-L-6-7
WR 42	18.0 - 26.5	42-125-L-6-7	42-124-L-6-7
WR 34	22.0 - 33.0	34-125-L-6-7	34-124-L-6-7
WR 28	26.5 - 40.0	28-125-L-6-7	28-124-L-6-7

Double Ridge W/G*

WRD 350	3.5-8.2	N/A	350-124-L-C3-C3
WRD 475	4.75 - 11.0	N/A	475-124-L-C3-C3
WRD 580	5.8 - 16.0	N/A	580-124-L-C3-C3
WRD 650	5.8 - 18.0	N/A	650-124-L-C3-C3
WRD 750	7.5 - 18.0	N/A	750-124-L-C3-C3

ARMORED FLEXIBLE WAVEGUIDE High Power, Non - Twistable Waveguide encased in Armor Jacket

- High - Power applications
- Armor Jacket
- Crush Resistant
- Kink Resistant



WG Size	Freq (GHz)	IL (dB/ft)	Power Avg	Max Pres. Peak	Flex Non- Twist with ARMOR Jacket Model No.*
WR90	8.20 - 12.4	0.11	2.2	150	90-126-(L)-6-6
WR75	10.0 - 15	0.15	2.1	125	75-126-(L)-6-6
WR62	12.4 - 18	0.16	1.3	100	62-126-(L)-6-6
WR51	15.0 - 22	0.2	1	75	51-126-(L)-6-6
WR42	18.0 - 26.5	0.25	0.6	35	42-126-(L)-6-6
WR34	22.0 - 33.0	0.3	0.5	20	34-126-(L)-6-6
WR28	26.5 - 40	0.35	0.5	20	28-126-(L)-6-6

ATM DOUBLE RIDGE FLANGE DESIGNATION & TYPE

Designation	Type	Holes
-C1	COVER	Alternate Tap/Thru
-C2		All Tapped
-C3		All Thru
-G1	GROOVE	Alternate Tap/Thru
-G2		All Tapped
-G3		All Thru

ATM RECTANGULAR FLANGE DESIGNATION & TYPE

Designation	Type
-1	CPRG
-2	CPRF
-3	CMR STANDARD
-4	CMR CLEAR (All Thru Holes)
-5	CMR TAP (All Tapped Holes)
-6	UG - Cover
-7	UG - Choke
-8	UG Cover/Groove
-9	PDR
-10	UDR

*L- Replace L with Length in Inches (or CM)



Standard ATM Horns



Horn with Radome Cover

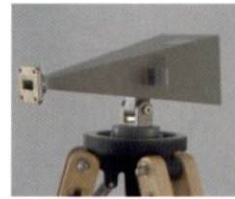

Tripod and Bracket Mounting



Wide Band Horns

STANDARD GAIN HORNS

- 10, 15, 20 and 24dB Gain
- Full Freq Band
- Bracket, Radome and Cal Options
- Coax [SMA, N, 7/16] Conn Options

WG Size (WR)	Freq (GHz)	Model No. (10dB Gain)	Model No. (15dB Gain)	Model No. (20dB Gain)	Model No. (High Gain)
WR 650	1.12 - 1.70	650-440-2	650-441-2	N/A	N/A
WR 430	1.70 - 2.60	430-440-2	430-441-2	430-442-2	N/A
WR 340	2.20 - 3.30	340-440-2	340-441-2	340-442-2	N/A
WR 284	2.60 - 3.95	284-440-6	284-441-6	284-442-6	284-443-6
WR 229	3.30 - 4.90	229-440-2	229-441-2	229-442-2	229-443-2
WR 187	3.95 - 5.85	187-440-6	187-441-6	187-442-6	187-443-6
WR 159	4.09 - 7.05	159-440-2	159-441-2	159-442-2	159-443-2
WR 137	5.85 - 8.20	137-440-2	137-441-2	137-442-2	137-443-2
WR 112	7.05 - 10.0	112-440-6	112-441-6	112-442-6	112-443-6
WR 102	7.00 - 11.0	102-440-6	102-441-6	102-442-6	102-443-6
WR 90	8.20 - 12.4	90-440-6	90-441-6	90-442-6	90-443-6
WR 75	10.0 - 15.0	75-440-6	75-441-6	75-442-6	75-443-6
WR 62	12.4 - 18.0	62-440-6	62-441-6	62-442-6	62-443-6
WR 51	15.0 - 22.0	51-440-6	51-441-6	51-442-6	51-443-6
WR 42	18.0 - 26.5	42-440-6	42-441-6	42-442-6	42-443-6
WR 34	22.0 - 33.0	34-440-6	34-441-6	34-442-6	34-443-6
WR 28	26.5 - 40.0	28-440-6	28-441-6	28-442-6	28-443-6

WIDE - BAND HORN ANTENNAS

- Wide Freq Bands
- Flange or Coax Conn Options
- Bracket, Radome and Cal Options
- Light Weight Aluminum

WG Size or Coax. Conn. Type	Freq (GHz)	Model No.	Gain (dB) (Low to High Freq.)
TYPE-N	0.7-1.8	07-18-440-NF	1.4-1.5
TYPE-N	0.75-1.12	975-441-NF	12.2-15.1
TYPE-N	1.0-2.5	150-441EM-NF	9-11
TYPE-N	1.0-2.5	150-442EM-NF	17-20
TYPE-N	1.0-12.0	1-12-440EM-NF	8-12
7/16 Female	2.0-4.0	2-4-442EM-7/16	17-22
7/16 Female	4.0-6.0	4-6-442EM-7/16	17.5-20.5
7/16 Female	6.0-8.0	6-8-442EM-7/16	18-20
WRD250	2.5-7.5	250-441-C3	7-13
TYPE-N	2.5-7.5	250-441EM-NF	7-13
WRD250	2.5-7.5	250-442-C3	18-20
TYPE-N	2.5-8.0	250-442EM-NF	18-20
WRD650	6.5-18.0	650-442-C3	19.0-24
TYPE-N	6.5-18.0	650-442EM-NF	19.0-24
WRD750	7.5-18.0	750-442-C3	20.5-24
TYPE-N	7.5-18.0	750-442EM-NF	20.5-24
WRD180	18.0-40.0	18.0-442-C3	14-19
K-TYPE (F)	18.0-40.0	18.0-442-KF	14-19

WAVEGUIDE TO COAX ADAPTERS



WR Right Angle



WR End Launch

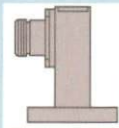

Right Angle

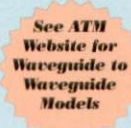

See ATM Website for Waveguide to Waveguide Models

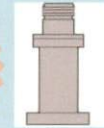

End Launch



WRD Right Angle

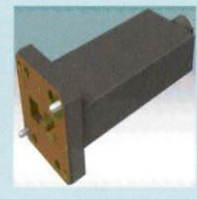

WRD End Launch

WAVEGUIDE TO COAX ADAPTERS

- Full Frequency Bands
- Flange and Coax Connector Options
- Coax Conn. [SMA, N, SC, TNC, 7/16]
- High Power Options
- VSWR: 1.25Max Std or 1.15Max Precision

Waveguide Size	Freq (GHz)	Model No. (SMA-f)	Model No. (Type N-f)	Precision SMA-F	Model No. (SMA-f)	Model No. (Type N-f)
WR 650	1.12 - 1.70	650-251A-2	650-253A-2	N/A	N/A	N/A
WR 430	1.70 - 2.60	430-251A-2	430-253A-2	N/A	430-201A-2	430-203A-2
WR 340	2.20 - 3.30	340-251A-2	340-253A-2	N/A	340-201A-2	340-203A-2
WR 284	2.60 - 3.95	284-251A-6	284-253A-6	284-251PrA-6	284-201A-6	284-203A-6
WR 229	3.30 - 4.90	229-251B-2	229-253B-2	229-251PrB-2	229-201B-2	229-203B-2
WR 187	3.95 - 5.85	187-251A-6	187-253A-6	187-251PrA-6	187-201A-6	187-203A-6
WR 159	4.90 - 7.05	159-251B-2	159-253B-2	159-251PrB-2	159-201B-2	159-203B-2
WR 137	5.80 - 8.20	137-251B-2	137-253B-2	137-251PrB-2	137-201B-2	137-203B-2
WR 112	7.05 - 10.0	112-251B-6	112-253B-6	112-251PrB-6	112-201A-6	112-203B-6
WR102	7.00 - 11.0	102-251A-6	102-253A-6	102-251PrA-6	102-201A-6	102-253A-6
WR 90	8.20 - 12.4	90-251A-6	90-253A-6	90-251PrA-6	90-201A-6	90-203A-6
WR 75	10.0 - 15.0	75-251A-6	75-253A-6	75-251PrA-6	75-201B-6	75-203B-6
WR 62	12.4 - 18.0	62-251A-6	62-253A-6	62-251PrA-6	62-201B-6	62-203B-6
WR 51	15.0 - 22.0	51-251B-6	N/A	51-251PrB-6	51-201B-6	N/A
WR 42	18.0 - 26.5	42-251B-6	N/A	42-25KPrA-6*	42-201B-6	N/A
WR 34	22.0 - 33.0	34-25KB-6*	N/A	34-25KPrB-6*	34-20KB-6	N/A
WR 28	26.5 - 40.0	28-25KA-6*	N/A	28-25KPrA-6*	28-20KA-6	N/A

* Type K connector

DOUBLE RIDGE WAVEGUIDE TO COAX ADAPTERS

- Full Frequency Bands
- Flange and Coax Connector Options
- Aluminum Only
- High Power Options
- VSWR: 1.25Max Std

Waveguide Size	Freq (GHz)	Model No. (SMA-f)	Model No. (Type N-f)
WRD 250	2.60 - 7.80	250-251-C1	250-253-C1
WRD 350	3.50 - 8.20	350-251-C1	350-253-C1
WRD 475	4.75 - 11.0	475-251-C1	475-253-C1
WRD 580	5.80 - 16.0	580-251-C1	580-253-C1
WRD 650	6.50 - 18.0	650-251-C1	650-253-C1
WRD 750	7.50 - 18.0	750-251-C1	750-253-C1
WRD 180	18.0 - 40.0	180-251-C1	180-253-C1
End Launch Models			
WRD 250	2.60 - 7.80	250-201-C1	250-203-C1
WRD 350	3.50 - 8.20	350-201-C1	350-203-C1
WRD 475	4.75 - 11.0	475-201-C1	475-203-C1
WRD 580	5.80 - 16.0	580-201-C1	580-203-C1
WRD 650	6.50 - 18.0	650-201-C1	650-203-C1
WRD 750	7.50 - 18.0	750-201-C1	750-203-C1
WRD 180	18.0 - 40.0	180-201-C1	180-203-C1

BROADWALL DIRECTIONAL COUPLERS



Description:

- Full waveguide frequency range
- Units pressure tested to 30 psi
- Ideal for High Power Combiner/Divider

Electrical Specifications:
 VSWR (MAX.) PRIMARY: 1.05 (1.10 for WR42, WR28)
 SECONDARY: 1.10 (1.15 for WR42, WR28)
 NOM. COUPLING (dB): ± .50 (± .75 for WR42, WR28)
 FREQ. SENS. (dB): ± .6 (± .75 for WR42, WR28)
 DIRECTIVITY (dB): 40 typical, 30 min.

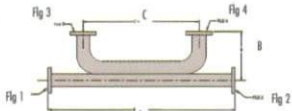

Ordering Information: Typical Part #: 137-310 B -10 -1 -1 -1

Basic Model #: _____
 Material: A=Alum, B=Brass, C=Copper, D=Special
 Coupling (dB): 3, 6, 10, 20, 30, 40
 Flange 1: 1=CPRG, 2=CPRF, 6=Cover, 7=Choke, 8= Groove
 Flange 2: See above
 Flange 3: See above
 Flange 4: See above

Basic Model No.	WG Size	Freq (GHz)	Dimension A (inches)	Dimension B (inches)	Dimension C (inches)
650-310	WR650	1.12 - 1.70	37	8.00	29.0
430-310	WR430	1.70 - 2.60	35	5.50	30.0
284-310	WR284	2.60 - 3.95	31	6.00	24.0
229-310	WR229	3.30 - 4.90	28	5.00	21.0
187-310	WR187	3.95 - 5.85	25	4.00	19.0
159-310	WR159	4.90 - 7.05	23	3.00	17.5
137-310	WR137	5.95 - 8.20	20	3.00	15.5
112-310	WR112	7.05 - 10.0	18	2.50	14.0
90-310	WR90	8.20 - 12.4	17	2.00	13.5
75-310	WR75	10.0 - 15.0	15	1.50	12.0
62-310	WR62	12.4 - 18.0	13	1.25	10.5
51-310	WR51	15.0 - 22.0	12	1.25	9.50
42-310	WR42	18.0 - 26.5	11	1.25	8.50
34-310	WR34	22.0 - 33.0	9	1.00	8.50
28-310	WR28	26.5 - 40.0	10	1.00	8.00
22-310	WR22	33.0 - 50.0	10	1.00	8.00

WAVEGUIDE COMBINER-DIVIDER

Short slot hybrid configuration
 Symmetrical 4 port device
 90 degree phase shift



WG Size WR	Freq (GHz)	VSWR Max	Isolation Min. dB	Model No.
284	2.66-2.99	1.15	26	284-261A-Z-6-6-6-6
28	36.0-40.0	1.15	26	28-264A-Z-6-6-6-6

SEE WEBSITE FOR OTHER MODELS

Flange Code: 2=CPRG; 6=Cover; 7=Choke

LOOP COUPLERS

Description:

- Full waveguide frequency range
- Units pressure tested to 30 psi
- Ideal for High Power Sensing

Electrical Specifications:
 VSWR: 1.1 max.
 NOM. COUPLING: +/- 1.00 dB
 FREQ. SENS.: +/- 1.00 dB max.
 DIRECTIVITY: 15 dB min.

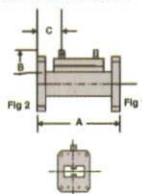

Ordering Information: Typical Part #: 75-307 B -30 -6 -6

Basic Model #: SMA F=307, N Type F=308
 Material: A=Alum, B=Brass, C=Copper, D=Special
 Coupling (dB): 30, 40, 50, 60 (Std.) others available
 Flange 1: 1=CPRG, 2=CPRF, 6=Cover, 7=Choke, 8= Groove
 Flange 2: See above

Basic Model No. (SMA F)	Basic Model No. (N Type F)	WG Size	Freq (GHz)	Dim. A (inches)	Dim. B (inches)	Dim. C (inches)
430-307	430-308	WR430	1.70 - 2.60	4.5	1.0	1.63
284-307	284-308	WR284	2.60 - 3.95	4.5	1.0	1.63
229-307	229-308	WR229	3.30 - 4.90	4.0	1.0	1.38
187-307	187-308	WR187	3.95 - 5.85	3.5	1.0	1.13
159-307	159-308	WR159	4.90 - 7.05	3.5	1.0	0.88
137-307	137-308	WR137	5.95 - 8.20	3.0	1.0	0.88
112-307	112-308	WR112	7.05 - 10.0	3.0	1.0	0.88
90-307	90-308	WR90	8.20 - 12.4	3.0	1.0	0.88
75-307	75-308	WR75	10.0 - 15.0	3.0	1.0	0.88
62-307	62-308	WR62	12.4 - 18.0	3.0	1.0	0.88
51-307		WR51	15.0 - 22.0	3.0	1.0	0.88
42-307		WR42	18.0 - 26.5	2.5	1.0	0.63
34-307		WR34	22.0 - 33.0	2.5	1.0	0.63
28-307		WR28	26.5 - 40.0	2.5	1.0	0.63
22-307		WR22	33.0 - 50.0	2.5	1.0	0.63

BROADWALL DIRECTIONAL COUPLERS

Description:

- Full waveguide frequency range
- Units pressure tested to 30 psi

• Ideal for High Power Combiner/Divider



Electrical Specifications:
 VSWR (MAX.) PRIMARY: 1.05 (1.10 for WR42, WR28)
 SECONDARY: 1.10 (1.15 for WR42, WR28)
 NOM. COUPLING (dB): ± .50 (± .75 for WR42, WR28)
 FREQ. SENS. (dB): ± .6 (± .75 for WR42, WR28)
 DIRECTIVITY (dB): 40 typical, 30 min.

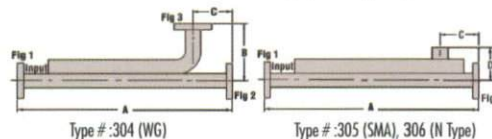

Ordering Information: Typical Part #: 137-304 B -10 -1 -1 -1

Basic Model #: 304 or 305 or 306
 Material: A=Alum, B=Brass, C=Copper, D=Special
 Coupling (dB): 3, 6, 10, 20, 30, 40
 Flange 1: 1=CPRG, 2=CPRF, 6=COVER, 7=CHOKE, 8= GROOVE
 Flange 2: See above
 Flange 3: See above

Basic Model No.	WG Size	Freq (GHz)	Dimension A (inches)	Dimension B (inches)	Dimension C (inches)
650-Type #	WR650	1.12 - 1.70			
430-Type #	WR430	1.70 - 2.60	60.00	9.00	5.00
284-Type #	WR284	2.60 - 3.95	50.25	6.00	2.66
229-Type #	WR229	3.30 - 4.90	42.00	6.81	1.84
187-Type #	WR187	3.95 - 5.85	34.62	6.44	1.81
159-Type #	WR159	4.90 - 7.05	32.50	5.25	1.56
137-Type #	WR137	5.95 - 8.20	26.50	3.06	1.56
112-Type #	WR112	7.05 - 10.0	18.62	3.06	1.56
90-Type #	WR90	8.20 - 12.4	16.68	2.50	1.50
75-Type #	WR75	10.0 - 15.0	15.00	2.50	1.25
62-Type #	WR62	12.4 - 18.0	13.75	2.18	0.66
51-Type #	WR51	15.0 - 22.0	11.50	1.25	0.66
42-Type #	WR42	18.0 - 26.5	9.50	1.25	0.75
34-Type #	WR34	22.0 - 33.0	9.00	1.25	0.75
28-Type #	WR28	26.5 - 40.0	8.00	1.12	0.75
22-Type #	WR22	33.0 - 50.0	8.00	1.12	0.75

CROSSGUIDE DIRECTIONAL COUPLERS

Description:

- Full waveguide frequency range
- Units pressure tested to 30 psi
- Ideal for High Power Combiner/Divider

Electrical Specifications:
 VSWR PRIMARY: 1.05 max.
 COAX SECONDARY: 1.25 max.
 NOM. COUPLING: ± 0.50 dB
 FREQ. SENS.: ± 1.00 dB max.
 DIRECTIVITY: 20 dB min.

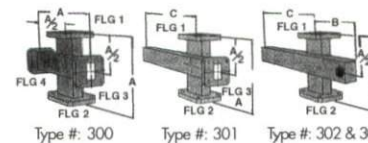

Type #s:
 300 = 4WG Ports
 301 = 3WG Ports
 302 = 2WG Ports,
 1 Type N (F) Coax Port
 303 = 2WG Ports
 1 SMA (F) Coax Port

Ordering Information: Typical Part #: 137-300 B -30 -1 -1 -1 -1

Basic Model #: _____
 Material: A=Alum, B=Brass, C=Copper, D=Special
 Coupling (dB): 30, 40, 50
 Flange 1: 1=CPRG, 2=CPRF, 6=Cover, 7=Choke, 8= Groove
 Flange 2: See above
 Flange 3: See above
 Flange 4: See above

Basic Model No.	WG Size	Freq (GHz)	Dim A (inches)	Dim. B (inches)	Dim. C (inches)
430-Type #	WR430	1.70 - 2.60	7.50	5.00	8.00
284-Type #	WR284	2.60 - 3.95	7.50	3.75	5.00
229-Type #	WR229	3.30 - 4.90	7.00	3.50	4.75
187-Type #	WR187	3.95 - 5.85	6.50	3.25	4.50
159-Type #	WR159	4.90 - 7.05	6.00	3.00	4.00
137-Type #	WR137	5.95 - 8.20	6.00	3.00	4.00
112-Type #	WR112	7.05 - 10.0	4.20	2.10	3.00
90-Type #	WR90	8.20 - 12.4	4.00	2.00	2.75
75-Type #	WR75	10.0 - 15.0	3.75	1.87	2.50
62-Type #	WR62	12.4 - 18.0	3.50	1.75	2.37
51-Type #	WR51	15.0 - 22.0	3.10	1.50	2.25
42-Type #	WR42	18.0 - 26.5	2.20	1.10	1.50
34-Type #	WR34	22.0 - 33.0	2.20	1.10	1.50
28-Type #	WR28	26.5 - 40.0	2.00	1.00	1.50
22-Type #	WR22	33.0 - 50.0	2.00	1.00	1.50

WAVEGUIDE COUPLERS

Short Length, High Directivity Couplers

Used in applications requiring short insertion length with high directivity

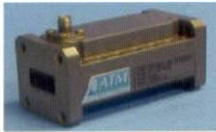

Single Output



Dual Output

GENERAL SPECIFICATIONS

- Std. coupling values: 30, 40, 50dB, Single or Dual Output
- Other coupling values available, but length of unit may change.
- Coupling Accuracy: +/- 0.5dB
- Frequency Sensitivity: +/- 0.5dB
- Directivity: 25dB min, 30dB typical

WG Size	Freq (GHz)	Standard Model No.*	Length (inches)
WR430	1.70 - 2.60	430-339A-dB-2-2	48.0
WR430	1.82 - 2.18	430-331A-dB-2-2	26.0
WR340	2.20 - 3.30	340-339A-dB-2-2	36.0
WR340	2.78 - 3.22	340-331A-dB-2-2	19.0
WR284	2.60 - 3.95	284-339A-dB-6-6	25.0
WR284	2.90 - 3.10	284-331A-dB-6-6	16.0
WR229	3.30 - 4.90	229-339A-dB-2-2	21.0
WR229	3.60 - 4.30	229-331A-dB-2-2	14.0
WR187	3.95 - 5.85	187-339A-dB-6-6	17.3
WR187	4.00 - 4.50	187-331A-dB-6-6	12.0
See website for entire List of Models			
WR62	12.4 - 18.0	62-339A-dB-6-6	8.1
WR62	15.0 - 18.0	62-331A-dB-6-6	3.0
WR51	15.0 - 22.0	51-337A-dB-6-6	3.0
WR51	18.2 - 21.0	51-331A-dB-6-6	3.0
WR42	17.7 - 21.0	42-331A-dB-6-6	3.0
WR42	18.0 - 26.5	42-337A-dB-6-6	3.0
WR34	22.0 - 33.0	34-337A-dB-6-6	3.0
WR34	27.8 - 32.2	34-331A-dB-6-6	2.75
WR28	26.5 - 40.0	28-337A-dB-6-6	3.0
WR28	27.3 - 32.7	28-331A-dB-6-6	2.5

Available in single or dual configuration

Rectangular Waveguide Power Samplers, SMA Female

Used to sample RF Power from the main line in a rectangular waveguide system.

TYPICAL SPECIFICATIONS

Electrical

- Full waveguide frequency range.
- Coupling: 30, 40, 50 dB standard, others available upon request.
- VSWR Primary: 1.05 max (1.08 max for 30dB coupling level) SMA arm: N/A
- Nominal Coupling: +/- 1.00dB
- Frequency Sensitivity: +/- 1.50dB max.

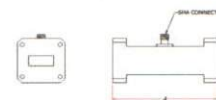

WG Size	Freq (GHz)	Standard Model No.*	Dim A (Inches)	Peak Power (Kw)	Average Power (W)
WR430	1.70 - 2.60	430-350A-dB-2-2	6.00	5000	4500
WR340	2.20 - 3.30	340-350A-dB-2-2	6.00	3700	3500
WR284	2.60 - 3.95	284-350A-dB-6-6	4.00	2200	2000
WR229	3.30 - 4.90	229-350B-dB-2-2	3.00	1300	1200
WR187	3.95 - 5.85	187-350A-dB-6-6	3.00	880	900
WR159	4.90 - 7.05	159-350B-dB-2-2	3.00	740	700
WR137	5.85 - 8.20	137-350B-dB-2-2	3.00	520	500
WR112	7.05 - 10.0	112-350B-dB-6-6	2.00	334	300
WR102	7.00 - 11.0	102-350B-dB-6-6	2.00	262	250
WR90	8.20 - 12.4	90-350A-dB-6-6	2.00	190	220
WR75	10.0 - 15.0	75-350B-dB-6-6	2.00	156	200
WR62	12.4 - 18.0	62-350B-dB-6-6	2.00	112	150
WR51	15.0 - 22.0	51-350B-dB-6-6	2.00	72	120
WR42	18.0 - 26.5	42-350B-dB-6-6	1.75	40	70
WR34	22.0 - 33.0	34-350B-dB-6-6**	1.75	32	70
WR28	26.5 - 40.0	28-350A-dB-6-6**	1.75	21	40

Double Ridge Models

WRD200	2.00 - 4.80	200-350-dB-C1-C1	2.50	30	2800
WRD250	2.60 - 7.80	250-350-dB-C1-C1	2.50	27	2350
WRD350	3.50 - 8.20	350-350-dB-C1-C1	2.30	26	2250
WRD475	4.80 - 11.0	475-350-dB-C1-C1	2.00	28	1800
WRD580	5.80 - 18.0	580-350-dB-C1-C1	2.00	22	900
WRD650	6.50 - 16.0	650-350-dB-C1-C1	2.00	10	480
WRD750	7.50 - 18.0	750-350-dB-C1-C1	2.00	7	330
WRD180	18.0 - 40.0	180-350-dB-C1-C1**	1.50	8	420

Double Ridge Waveguide Loop Coupler - SMA (F)

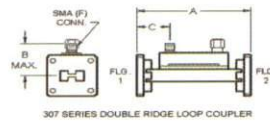
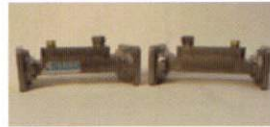

GENERAL SPECIFICATIONS

Electrical

- VSWR:
 - Primary: 1.07 Max
 - Coax: 1.35 Max (SMA F) 1.50 Max (TypeN F)
- Coupling: 30, 40, 50, or 60dB std., others available upon request.
- Nominal Coupling: +/- 1.00 dB
- Frequency Sensitivity: +/- 1.00dB max.
- Directivity: 15dB min., 20dB typ.
- RF Connectors: SMA-F, Type-N-F (Standard)
- Full waveguide frequency range
- Units pressure tested to 30 psi
- Ideal for High Power Sensing
- Single Arm standard, Multi-arm available

WG Size	Freq (GHz)	Basic Model No.*	Dim A (Inches)	Dim B (Inches)	Dim C (Inches)
WRD750	7.50 - 18.0	750-307-dB-C3-C3	2.5	0.9	0.63
WRD650	6.50 - 18.0	650-307-dB-C3-C3	2.5	0.9	0.63
WRD580	5.85 - 14.5	580-307-dB-C3-C3	3.0	1.0	0.88
WRD475	4.75 - 11.0	475-307-dB-C3-C3	3.5	1.1	1.13

Double Ridge Waveguide Loop Coupler - Type N (F)

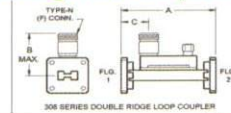

WG Size	Freq (GHz)	Basic Model No.*	Dim A (Inches)	Dim B (Inches)	Dim C (Inches)
WRD750	7.50 - 18.0	750-308-dB-C3-C3	2.5	0.8	0.63
WRD650	6.50 - 18.0	650-308-dB-C3-C3	2.5	0.8	0.63
WRD580	5.85 - 14.5	580-308-dB-C3-C3	3.0	0.8	0.88
WRD475	4.75 - 11.0	475-308-dB-C3-C3	3.5	0.8	1.13

Rectangular W/G Pressure Windows

- Standard Applications - 230 series Teflon-Fiberglass window
- Vacuum Applications - 233 Kapton window



WG Size	Freq. GHz	Power (Watts)-CW	Power (kW)-Peak	Pressure (PSIG)	Standard Model No. Material:	VSWR
Teflon fiberglass						
WR340	2.20 - 3.30	1800	3500	15	340-230-6-6	1.06
WR284	2.60 - 3.95	1300	2000	15	284-230-6-6	1.06
WR229	3.30 - 4.90	1300	1800	20	229-230-2-2	1.07
WR187	3.95 - 5.85	1300	1500	25	187-230-6-6	1.06
WR159	4.90 - 7.05	1200	1000	30	159-230-2-2	1.05
WR137	5.85 - 8.20	1000	750	35	137-230-2-2	1.07
WR112	7.05 - 10.0	1000	500	40	112-230-6-6	1.1
WR102	7.0 - 11.0	1000	400	40	102-230-6-6	1.15
WR90	8.20 - 12.4	900	300	40	90-230-6-6	1.1
WR75	10.0 - 15.0	800	200	40	75-230-6-6	1.09
WR62	12.4 - 18.0	700	150	40	62-230-6-6	1.08
WR51	15.0 - 22.0	500	100	40	51-230-6-6	1.12
WR42	18.0 - 26.5	400	75	40	42-230-6-6	1.12
WR34	22.0 - 33.0	400	60	40	34-230-6-6	1.15
WR28	26.5 - 40.0	250	45	40	28-230-6-6	1.18

Rectangular W/G Vacuum Pressure Windows (material KAPTON)

WR284	2.60 - 3.95	1300	N/A	15	284-233-6-6	1.06
WR229	3.30 - 4.90	1200	N/A	15	229-233-2-2	1.07
WR187	3.95 - 5.85	1200	N/A	15	187-233-6-6	1.06
WR159	4.90 - 7.05	700	N/A	15	159-233-2-2	1.05
WR137	5.85 - 8.20	500	N/A	15	137-233-2-2	1.07
WR112	7.05 - 10.0	400	N/A	15	112-233-6-6	1.10
WR102	7.0 - 11.0	400	N/A	15	102-233-6-6	1.15
WR90	8.20 - 12.4	400	N/A	15	90-233-6-6	1.10
WR75	10.0 - 15.0	375	N/A	15	75-233-6-6	1.09
WR62	12.4 - 18.0	375	N/A	15	62-233-6-6	1.08
WR51	15.0 - 22.0	350	N/A	15	51-233-6-6	1.12
WR42	18.0 - 26.5	320	N/A	15	42-233-6-6	1.12
WR34	22.0 - 33.0	250	N/A	15	34-233-6-6	1.15
WR28	26.5 - 40.0	100	N/A	15	28-233-6-6	1.18

Double Ridge W/G Pressure Windows

WG Size	Freq. GHz	VSWR	Avg. CW (Watts)	Peak (kW)	Pressure (PSIG)	Material	Standard Model No.
WRD200	2.00 - 4.80	1.09	600	1	15	Kapton	200-233-C3-C3
WRD250	2.50 - 7.80	1.09	600	1	15	Kapton	250-233-C3-C3
WRD350	3.50 - 8.20	1.09	600	1	15	Kapton	350-233-C3-C3
WRD475	4.75 - 11.0	1.09	600	1	15	Kapton	475-233-C3-C3
WRD650	6.50 - 18.2	1.09	600	1	15	Kapton	650-233-C3-C3
WRD750	7.50 - 18.0	1.09	600	1	15	Kapton	750-233-C3-C3
WRD750	7.50 - 18.0	1.09	600	1	15	Teflon/glass	750-230-C3-C3

SHORT TERMINATION

Description:

- Full waveguide frequency range
- Units pressure tested to 30 psi
- Finish is a unique corrosion-resistant 316 stainless steel epoxy coating

- VSWR: 1.20 max
- ATM series 710 Terminations utilize Medium Power Elements to achieve low VSWR and stable electrical characteristics

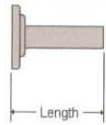

Ordering Information: Typical Part #: 137-710 B -2

Basic Model #: _____
 Material: A=Alum, B=Brass, C=Copper, D=Special
 Flange 1: 1=CPRG, 2=CPRF, 6=COVER, 7=CHOKE, 8=GROOVE

Basic Model No.	WG Size	Freq (GHz)	Standard Flange	Power Avg. (W)	Length (inches)
650-710	WR650	1.12 - 1.70	CPRF (2)	50	7.00
430-710	WR430	1.70 - 2.60	CPRF (2)	40	7.00
340-710	WR340	2.20 - 3.30	CPRF (2)	40	6.00
284-710	WR284	2.60 - 3.95	COVER (6)	30	3.00
229-710	WR229	3.30 - 4.90	CPRF (2)	25	3.00
187-710	WR187	3.95 - 5.85	COVER (6)	25	2.50
159-710	WR159	4.90 - 7.05	CPRF (2)	20	2.00
137-710	WR137	5.95 - 8.20	CPRF (2)	15	1.75
112-710	WR112	7.05 - 10.00	COVER (6)	15	1.50
102-710	WR102	7.00 - 11.00	COVER (6)	15	1.50
90-710	WR90	8.20 - 12.40	COVER (6)	15	1.50
75-710	WR75	10.00 - 15.00	COVER (6)	15	1.25
62-710	WR62	12.40 - 18.00	COVER (6)	10	1.00
51-710	WR51	15.00 - 22.00	COVER (6)	10	1.00
42-710	WR42	18.00 - 26.50	COVER (6)	10	1.00
34-710	WR34	22.00 - 33.00	COVER (6)	5	0.75
28-710	WR28	26.50 - 40.00	COVER (6)	5	0.75
22-710	WR22	33.00 - 50.00	COVER (6)	5	0.75

LOW POWER TERMINATION

Description:

- Full waveguide frequency range
- Units pressure tested to 30 psi
- Finish is a unique corrosion-resistant 316 stainless steel epoxy coating

- ATM series 720 Terminations utilize a Precision Conical Element to achieve very low VSWR.
- For short size on High Power Terminations contact factory

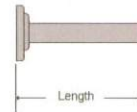

Ordering Information: Typical Part #: 137-720 B -2

Basic Model #: _____
 Material: A=Alum, B=Brass, C=Copper, D=Special
 Flange 1: 1=CPRG, 2=CPRF, 6=COVER, 7=CHOKE, 8=GROOVE

Basic Model No.	WG Size	Freq (GHz)	Standard Flange	VSWR max.	Power Avg. (W)	Length (inches)
650-720	WR650	1.12 - 1.70	CPRF (2)	1.02	25	12.50
430-720	WR430	1.70 - 2.60	CPRF (2)	1.02	15	11.00
340-720	WR340	2.20 - 3.30	CPRF (2)	1.01	12	10.75
284-720	WR284	2.60 - 3.95	COVER (6)	1.01	10	10.75
229-720	WR229	3.30 - 4.90	CPRF (2)	1.01	10	7.50
187-720	WR187	3.95 - 5.85	COVER (6)	1.01	8	6.25
159-720	WR159	4.90 - 7.05	CPRF (2)	1.01	7	6.00
137-720	WR137	5.95 - 8.20	CPRF (2)	1.01	6	5.50
112-720	WR112	7.05 - 10.00	COVER (6)	1.01	4	5.00
102-720	WR102	7.00 - 11.00	COVER (6)	1.01	3	4.00
90-720	WR90	8.20 - 12.40	COVER (6)	1.01	4	4.00
75-720	WR75	10.00 - 15.00	COVER (6)	1.01	2	4.00
62-720	WR62	12.40 - 18.00	COVER (6)	1.01	1.5	4.00
51-720	WR51	15.00 - 22.00	COVER (6)	1.01	1.0	4.00
42-720	WR42	18.00 - 26.50	COVER (6)	1.01	0.5	2.50
34-720	WR34	22.00 - 33.00	COVER (6)	1.01	0.5	2.50
28-720	WR28	26.50 - 40.00	COVER (6)	1.02	0.5	2.00
22-720	WR22	33.00 - 50.00	COVER (6)	1.02	0.5	1.50

MEDIUM POWER TERMINATION

Description:

- Full waveguide frequency range
- Units pressure tested to 30 psi
- Finish is a high temp. black coating
- Low outgassing characteristics
- VSWR: 1.10 max

- ATM series 740 utilizes High Power Ceramic Elements fired at 1300 C for low VSWR and stable electrical characteristics

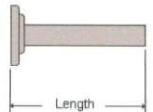

Ordering Information: Typical Part #: 137-740 B -2

Basic Model #: _____
 Material: A=Alum, B=Brass, C=Copper, D=Special
 Flange 1: 1=CPRG, 2=CPRF, 6=COVER, 7=CHOKE, 8=GROOVE

Basic Model No.	WG Size	Freq (GHz)	Standard Flange	Power Avg. (W)	Length (inches)
650-740	WR650	1.12 - 1.70	CPRF (2)	1500	13.00
430-740	WR430	1.70 - 2.60	CPRF (2)	1200	12.00
340-740	WR340	2.20 - 3.30	CPRF (2)	1200	12.00
284-740	WR284	2.60 - 3.95	COVER (6)	1200	11.00
229-740	WR229	3.30 - 4.90	CPRF (2)	1000	9.75
187-740	WR187	3.95 - 5.85	COVER (6)	750	8.38
159-740	WR159	4.90 - 7.05	CPRF (2)	625	8.00
137-740	WR137	5.95 - 8.20	CPRF (2)	500	8.00
112-740	WR112	7.05 - 10.00	COVER (6)	425	7.00
102-740	WR102	7.00 - 11.00	COVER (6)	325	6.50
90-740	WR90	8.20 - 12.40	COVER (6)	225	5.50
75-740	WR75	10.00 - 15.00	COVER (6)	200	4.50
62-740	WR62	12.40 - 18.00	COVER (6)	100	3.25
51-740	WR51	15.00 - 22.00	COVER (6)	100	3.25
42-740	WR42	18.00 - 26.50	COVER (6)	100	3.50
34-740	WR34	22.00 - 33.00	COVER (6)	75	3.25
28-740	WR28	26.50 - 40.00	COVER (6)	75	4.00
22-740	WR22	33.00 - 50.00	COVER (6)	25	2.50

HIGH POWER

Description:

- Full waveguide frequency range
- Units pressure tested to 30 psi
- Finish is a high temperature black coating
- All 745 series Terminations are manufactured from 6061 Aluminum
- Low outgassing characteristics
- VSWR: 1.10 max
- ATM series 745 utilizes High Power Ceramic Elements fired at 1300 C for low VSWR and stable electrical characteristics

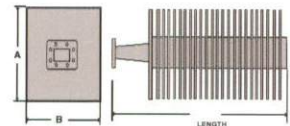

Ordering Information: Typical Part #: 137-745 -2

Basic Model #: _____
 Flange 1: 1=CPRG, 2=CPRF, 6=COVER, 7=CHOKE, 8=GROOVE

Basic Model No.	WG Size	Freq (GHz)	Standard Flange	Power Avg. (W)	Length (inches)	Dim. A	Dim. B
650-745	WR650	1.12 - 1.70	CPRF (2)	2500	13.00	9.00	11.00
430-745	WR430	1.70 - 2.60	CPRF (2)	2500	12.00	6.00	6.00
340-745	WR340	2.20 - 3.30	CPRF (2)	2500	12.00	6.00	6.00
284-745	WR284	2.60 - 3.95	COVER (6)	2400	12.00	6.00	5.00
229-745	WR229	3.30 - 4.90	CPRF (2)	2000	10.63	5.00	5.00
187-745	WR187	3.95 - 5.85	COVER (6)	1500	9.00	4.50	4.50
159-745	WR159	4.90 - 7.05	CPRF (2)	1300	9.00	4.50	4.50
137-745	WR137	5.95 - 8.20	CPRF (2)	1000	8.50	4.00	4.00
137-745A	WR137	5.95 - 8.20	CPRF (2)	1500	9.00	4.50	4.50
112-745	WR112	7.05 - 10.00	COVER (6)	850	8.00	4.00	4.00
102-745	WR102	7.00 - 11.00	COVER (6)	500	6.50	3.50	3.50
90-745	WR90	8.20 - 12.40	COVER (6)	500	5.50	3.50	3.50
75-745	WR75	10.00 - 15.00	COVER (6)	350	5.00	3.50	3.50
75-745A	WR75	10.00 - 15.00	COVER (6)	550	5.00	4.50	4.50
62-745	WR62	12.40 - 18.00	COVER (6)	250	4.50	3.00	3.00
51-745A	WR51	15.00 - 22.00	COVER (6)	260	4.50	3.00	3.00
42-745	WR42	18.00 - 26.50	COVER (6)	230	4.50	2.25	2.25
34-745	WR34	22.00 - 33.00	COVER (6)	150	4.00	2.00	2.00
28-745	WR28	26.50 - 40.00	COVER (6)	125	4.00	2.00	2.00
22-745	WR22	33.00 - 50.00	COVER (6)	75	3.00	1.50	1.50

WG Size	Freq (GHz)	Avg. Power (WATTS)	Standard Model No.*
WR284	2.60 - 3.95	7000	284-770-6
WR229	3.30 - 4.90	1200	229-770-1200-2
WR229	3.30 - 4.90	1200	229-770-2
WR187	3.95 - 5.85	4200	187-770-6
WR159	4.90 - 7.05	4200	159-770-2
WR137	5.85 - 8.20	4200	137-770-2
WR112	7.05 - 10.0	2700	112-770-6
WR90	8.20 - 12.4	2100	90-770-6
WR75	10.0 - 15.0	2000	75-770-6
WR62	12.4 - 18.0	2000	62-770-6
WR51	15.0 - 22.0	1700	51-770-6
WR42	18.0 - 26.5	1500	42-770-6
WR34	22.0 - 33.0	800	34-770-6
WR28	26.5 - 40.0	500	28-770-6
WR28	26.5 - 40.0	700	28-770-6
WR22	33.0 - 50.0	700	22-770-6

WATER COOLED LOAD, HIGH POWER - 770 SERIES

- Low out-gassing characteristics. 6061 Aluminum
- Low VSWR (1.15Max) and stable electrical characteristics.
- Cooling Fluid (15° to 21° C) Flow Rates:
 - 4 gal/min for sizes WR650 thru WR159
 - 2 gal/min for sizes WR137 thru 112
 - 1 gal/min for sizes WR90 thru WR22



Rectangular W/G Termination, Very High Power - 760/780 Series

- Full waveguide frequency range.
- Units may be pressure sealed up to 30 psi. upon request. [PT option]
- Low outgassing characteristics.
- VSWR: 1.15 max.
- Terminations are 6061 Aluminum, with Finish: Hi-Temp black
- High Power Ceramic Elements fired at 1300 C for low VSWR and stable electrical characteristics.
- Units are best mounted in the horizontal plane with free air flow. The load temperature will vary depending on power levels and duration. If during use the surface temperature approaches 260°C at the hottest point, (normally where the first fin touches the waveguide body), forced air cooling should be used to prevent damage to the internal load element. Units can survive temperatures as high as 450 °C without damage for a short time.

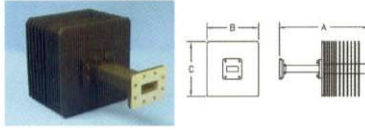

WG Size	Freq (GHz)	Avg. Power (Watts)	Peak Power (kW)	Standard Model No.*	Dim A (inches)	Dim.B	DimC
WR650	1.12 - 1.70	8000	5500	650-760-2	30.00	14.00	12.00
WR430	1.70 - 2.60	6500	4000	430-760-2	16.67	9.00	9.00
WR340	2.20 - 3.30	5500	3500	340-760-2			
WR284	2.60 - 3.95	5000	3200	284-760-6	13.75	6.00	6.00
WR229	3.30 - 4.90	4000	2000	229-760-2	13.75	6.00	6.00
WR187	3.95 - 5.85	3000	2000	187-760-6	18.00	6.00	6.00
WR159	4.90 - 7.05	3000	1000	159-760-2	21.50	6.00	6.00
WR137	5.85 - 8.20	3000	710	137-760-2	18.00	6.00	6.00
WR112	7.05 - 10.0	3000	550	112/187-760-6	20.00	6.00	6.00
WR112	7.05 - 10.0	1900	460	112-760-6	8.80	5.00	5.00
WR90	8.20 - 12.4	4500	450	90/187-760-6	24.00	6.00	6.00
WR90	8.20 - 12.4	1100	290	90-760-6	9.81	5.00	5.00
WR75	10.0 - 15.0	3500	270	75/187-760-6	24.83	6.00	6.00
WR75	10.0 - 15.0	1500	250	75/780-1500-6	14.00	5.00	4.48
WR75	10.0 - 15.0	1000	200	75-760-6	7.75	4.50	4.50
WR62	12.4 - 18.0	3000	200	62/187-760-6	24.63	6.00	6.00
WR62	12.4 - 18.0	900	160	62-760-6	7.86	4.50	4.50
WR51	15.0 - 22.0	775	150	51-760-6	7.75	4.50	4.50
WR42	18.0 - 26.5	600	120	42-760-6	5.50	2.25	2.25
WR34	22.0 - 33.0	500	100	34-760-6	6.37	2.25	2.25
WR28	26.5 - 40.0	200	100	28-760-6	6.56	2.25	2.25
WR28	26.5 - 40.0	500	100	28-780-6	7.00	2.50	2.50
WR22	33.0 - 50.0	500	100	22/28-780-6	9.00	2.50	2.50

WG High Power Fixed Precision Attenuators

High-Power precision attenuators covering the waveguide sizes WR28 through WR430 and attenuation values of 10dB, 20dB, 30dB, 40dB and 50dB.

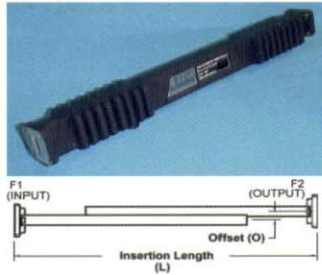

GENERAL SPECIFICATIONS (All Options)

- Electrical
- Std. Attenuation values: 10, 20, 30, 40, 50dB
- Nominal Attenuation accuracy: +/- 0.50dB (+/- 0.75dB for WR42, WR34, WR28)
- Freq. Sensitivity: +/- 0.60 dB
- (+/- 0.75dB for WR42, WR34, WR28)
- Applicable Mil-Specs
- General:
- Product Specific:
- Mechanical
- Size: See Tables
- Body: Aluminum
- Finish: Hi-Temp Black

WG Size	Freq (GHz)	VSWR	Power Watt	Standard Model No.*	Dimensions	
					Length (L) inches	Offset (O) inches
WR430	1.70 - 2.60	1.15	1200	430-630HPA-dB-2-2	54.0	2.230
WR340	2.20 - 3.30	1.15	1200	340-630HPA-dB-2-2	42.0	1.780
WR284	2.60 - 3.95	1.15	1200	284-630HPA-dB-6-6	33.0	1.420
WR229	3.30 - 4.90	1.15	1000	229-630HPA-dB-2-2	27.0	1.209
WR187	3.95 - 5.85	1.15	750	187-630HPA-dB-6-6	24.0	0.936
WR159	4.9 - 7.05	1.15	625	159-630HPA-dB-2-2	24.0	0.859
WR137	5.85 - 8.20	1.15	500	137-630HPA-dB-2-2	22.5	0.686
WR112	7.05 - 10.0	1.15	425	112-630HPA-dB-6-6	16.0	0.561
WR90	8.20 - 12.4	1.15	225	90-630HPA-dB-6-6	14.5	0.450
WR75	10.0 - 15.0	1.15	200	75-630HPA-dB-6-6	13.5	0.425
WR62	12.4 - 18.0	1.15	100	62-630HPA-dB-6-6	11.5	0.351
WR51	15.0 - 22.0	1.15	100	51-630HPA-dB-6-6	11.5	0.295
WR42	18.0 - 26.5	1.15	100	42-630HPA-dB-6-6	9.5	0.210
WR34	22.0 - 33.0	1.15	75	34-630HPA-dB-6-6	9.5	0.210
WR28	26.5 - 40.0	1.15	75	28-630HPA-dB-6-6	9.0	0.180

WG Variable Attenuators

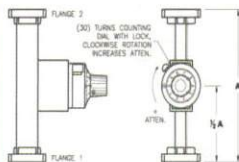

SPECS					LEVEL ADJUST		FLAT WITH FREQUENCY	
WG Size	Freq (GHz)	Avg. Power (Watts)	Length (L) inches	Standard Model No.*	Flatness +/- dB	Standard Model No.*	Flatness +/- dB	
WR284	2.60 - 3.95	11	10	284-620A-30-6-6	N/A	284-AF620A-10-6-6	+/- 1.0dB	
WR229	3.30 - 4.90	9	9	229-620B-30-2-2	N/A	229-AF620B-10-2-2	+/- 1.0dB	
WR187	3.95 - 5.85	7	8.5	187-620B-30-6-6	N/A	187-AF620A-10-6-6	+/- 1.0dB	
WR159	4.9 - 7.05	5	8	159-620B-30-2-2	N/A	159-AF620B-10-2-2	+/- 1.0dB	
WR137	5.95 - 8.20	4	6	137-620B-30-2-2	N/A	137-AF620B-10-2-2	+/- 1.0dB	
WR112	7.05 - 10.0	3	5	112-620B-30-6-6	N/A	112-AF620B-10-6-6	+/- 1.0dB	
WR90	8.20 - 12.4	2	4	90-620A-30-6-6	N/A	90-AF620A-10-6-6	+/- 1.0dB	
WR75	10.0 - 15.0	1	3	75-620B-30-6-6	N/A	75-AF620B-20-6-6	+/- 1.0dB	
WR62	12.4 - 18.0	1	3	62-620B-30-6-6	N/A	62-AF620B-15-6-6	+/- 1.5dB	
WR51	15.0 - 22.0	1	3	51-620A-30-6-6	N/A	51-AF620A-10-6-6	+/- 2.0dB	
WR42	18.0 - 26.5	1	3	42-620A-30-6-6	N/A	42-AF620A-10-6-6	+/- 3.0dB	
WR34	22.0 - 33.0	1	3	34-620A-30-6-6	N/A	34-AF620A-10-6-6	+/- 3.0dB	
WR28	26.5 - 40.0	1	3	28-620A-30-6-6	N/A	28-AF620A-10-6-6	+/- 3.0dB	

Double Ridge W/G Termination, Low & Med. Power - 720/740 Series

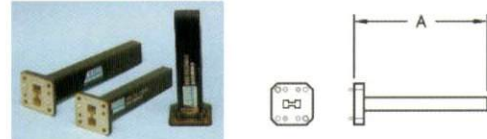

WG Size	Freq (GHz)	Standard Model No.*	Avg. Power (Watts)	Typical VSWR	Dim A (inches)
WRD350	3.50-8.20	350-720-C3	1	1.05	13
WRD350	3.50-8.20	350-740-C3	300	1.10	13f
WRD475	4.75-11.0	475-720-C3	1	1.05	8.50
WRD475	4.75-11.0	475-740-C3	240	1.10	8.50
WRD580	5.80-16.0	580-720-C3	1	1.05	8.50
WRD580	5.80-16.0	580-740-C3	200	1.10	8.50
WRD650	6.50-18.0	650-720-C3	1	1.05	7.50
WRD650	6.50-18.0	650-740-C3	200	1.10	8.50
WRD750	7.50-18.0	750-720-C3	1	1.05	8.50
WRD750	7.50-18.0	750-740-C3	200	1.10	8.50
WRD180	18.00-40.0	180-720-C3	1	1.15	4.00
WRD180	18.00-40.0	180-740-C3	30	1.15	4.00

Double Ridge W/G Terminations, High Power - 745 Series



WG Size	Freq (GHz)	Standard Model No.*	Avg. Power (Watts)	VSWR	Dim A (inches)	Dim B.
WRD250	2.5-7.5	250-745-1000-C3	1000	1.15	11.50	4.50
WRD475	4.75-11.0	475-745-C3	1000	1.10	12.00	6.00
WRD580	5.80-16.0	580-745-C3	1000	1.10	9.50	5.00
WRD580	5.80-16.0	580-745-C3	750	1.10	9.50	5.00
WRD650	6.50-18.0	650-745-C3	700	1.10	10.00	5.00
WRD750	7.50-18.0	750-745-C3	700	1.10	10.00	5.00

Double Ridge W/G Terminations, Very High Power - 760/780 Series

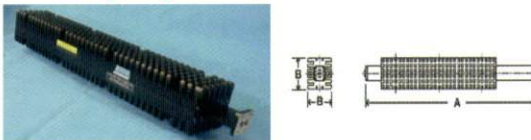

WG Size	Freq (GHz)	Standard Model No.*	Avg. Power (Watts)	VSWR	Dim A (inches)	Dim B.
WRD250	2.5-7.5	250-780-1800-C3	1800	1.15		
WRD250	2.5-7.5	250-780-2200-C3	2200	1.15	38.50	5.25x6.65
WRD750	7.5-18.0	750-780-1500-C3	1500	1.15	22.00	3.00
WRD580	5.8-16.0	580-780-1500-C3	1500	1.15	22.00	3.00
WRD650	6.5-18.0	650-780-1500-C3	1500	1.15	22.00	3.00
WRD180	18.0-40.0	180-780-150-C3	150	1.15	10.0	2.50

Units are best mounted in the horizontal plane with free air flow. The load temperature will vary depending on power levels and duration. If during use the surface temperature approaches 260°C at the hottest point, (normally where the first fin touches the waveguide body), forced air cooling should be used to prevent damage to the internal load element. Units can survive temperatures as high as 450 °C without damage for a short time.

Flange Code: C=Flat, G=Groove, 1=alternate holes, 2=all tapped holes, 3=all thru holes
Example 580-720-G1, Other Flanges Available.

WAVEGUIDE QUICK CONNECTS



- Connects and disconnects waveguides without use of screws and nuts.
- One flange **MUST** be tapped for the nylon positioning screws.
- Easy Installation to existing assembly if one flange is tapped
- Connects Waveguides by several turns of a threaded ring.
- Dust Covers available for most W/G sizes

Rectangular Waveguide Quick Disconnects

MODEL NO.	WG SIZE	MATES FLANGES:*
QD-284	WR284	CPR
QD-229	WR229	CPR
QD-159	WR159	CPR
QD-137	WR137	CPR
QD-112	WR112	Cover/Groove/Choke
QD-90	WR90	Cover/Groove/Choke
QD-75	WR75	Cover/Groove/Choke/CPR
QD-62	WR62	Cover/Groove/Choke
QD-51	WR51	Cover/Groove/Choke
QD-42HQ	WR42	Cover/Groove/Choke
QD-34HQ	WR34	Cover/Groove/Choke
QD-28HQ	WR28	Cover/Groove/Choke

Double Ridge Waveguide Quick Disconnects

MODEL NO.	WG SIZE	MATES FLANGES:*
QD-350	WR350	Cover/Groove
QD-580	WR580	Cover Groove
QD-650	WR650	Cover Groove
QD-750	WR750	Cover Groove

WAVEGUIDE GASKETS

Gasket Kit
Gasket & Flange hardware, available for all gasket types

Gasket Full
O-Ring type for U/G Style Flanges

Gasket Full
for CPR style Flanges

Gasket Half
for CPR style Flanges

Gasket Die Cut
for flat or grooved Flanges

- ATM offers Gaskets for all waveguide sizes and flange types.
- Both Non Conductive [Pressure Seal] and Conductive [Pressure and RF Seal] styles.

HOW TO SELECT THE CORRECT GASKET?

- The ATM **GASKET SELECTION AID** makes ordering gaskets easy and worry free.
- Go to ATM WEB
http://www.atmmicrowave.com/calc_wg_gasket_frame.html
- Enter the waveguide size EX: (WR90) and click LOOKUP and it will provide the various part numbers for your Flange configuration

Waveguide Gasket Type Selection Aid

Specify WR Waveguide Size: L.e. Enter "90" for WR90

Gasket #	CPR Flange Combinations			
	CPRG/CPRG	CPRG/CPRF	CPRF/CPRF	
Gasket Type	Non-Conductive	Full G90A1F *	N/A	N/A
	Half	N/A	G90A1H *	N/A
Conductive	Die-Cut	G90B2D *	G90B2D *	G90B2D *
	Full	G90B1F **	N/A	N/A
Half	N/A	G90B1H	N/A	

Gasket #	UG Style Flange Combinations			
	Cover/Cover	Cover/Choke	Cover/Cover-Groove	Cover-Groove/Cover-Groove
Gasket Type	Non-Conductive	O-Ring G90A7F *	G90A7F *	G90B6D *
	Conductive	Die-Cut O-Ring	G90B6D *	G90B7F **
		G90B7F **	G90B7F **	

PRESSURIZING SECTIONS & INLETS

- For pressurizing a waveguide system with air or other gases
- With a pressure gauge to monitor the internal pressure at all times or without
- Also available are Short length pipe-tapped pressurizing sections
- See ATM WEB for Waveguide Passive Dehydrators

Pressurizing Sections

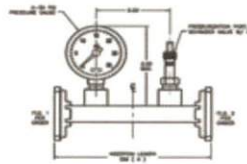

WG Size	Freq (GHz)	Pressure Section with gauge		Pressure Section without gauge	
		Standard Model No.	Length (A) (inches)	Standard Model No.	Length (A) (inches)
WR650	1.12 - 1.70	650-210A-2-2	6.00	650-212A-2-2	4.00
WR430	1.70 - 2.60	430-210A-2-2	6.00	430-212A-2-2	4.00
WR340	2.20 - 3.30	340-210A-2-2	6.00	340-212A-2-2	4.00
WR284	2.60 - 3.95	284-210A-6-6	6.00	284-212A-6-6	4.00
WR229	3.30 - 4.90	229-210B-2-2	6.00	229-212B-2-2	4.00
WR187	3.95 - 5.85	187-210A-6-6	5.00	187-212A-6-6	3.00
WR159	4.9 - 7.05	159-210B-2-2	5.00	159-212B-2-2	3.00
WR137	5.95 - 8.20	137-210B-2-2	4.25	137-212B-2-2	2.25
WR112	7.05 - 10.0	112-210B-6-6	4.25	112-212B-6-6	2.25
WR90	8.20 - 12.4	90-210A-6-6	4.25	90-212A-6-6	2.25
WR75	10.0 - 15.0	75-210B-6-6	4.25	75-212B-6-6	2.25
WR62	12.4 - 18.0	62-210B-6-6	4.25	62-212B-6-6	2.25
WR51	15.0 - 22.0	51-210B-6-6	4.25	51-212B-6-6	2.25
WR42	18.0 - 26.5	42-210B-6-6	4.25	42-212B-6-6	2.25
WR34	22.0 - 33.0	34-210B-6-6	4.25	34-212B-6-6	2.25
WR28	26.5 - 40.0	28-210B-6-6	4.25	28-212B-6-6	2.25
WR22	33.0 - 50.0	22-210B-6-6	4.25	22-212B-6-6	2.25
WR22	33.0 - 50.0	22-210B-6R-6R	4.25	22-212B-6R-6R	2.25

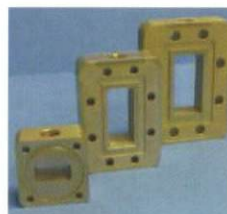

Note: Flange Spacer Inlets are provided with 1/8-27 NPT Inlets, standard.

The Standard Model Numbers above are the most common parts ordered for size, material and flange. These models can easily be altered to accommodate your requirements using cataloging info on ATM WEB,

Flange Spacer Inlets

WG Size	Freq (GHz)	Standard Model No.	Flange Thickness (inches)
WR650	1.12 - 1.70	650-211A-2-2	0.75
WR430	1.70 - 2.60	430-211A-2-2	0.75
WR340	2.20 - 3.30	340-211A-2-2	0.75
WR284	2.60 - 3.95	284-211A-6-6	0.75
WR229	3.30 - 4.90	229-211B-2-2	0.75
WR187	3.95 - 5.85	187-211A-6-6	0.75
WR159	4.90 - 7.05	159-211B-2-2	0.75
WR137	5.95 - 8.20	137-211B-2-2	0.75
WR112	7.05 - 10.0	112-211B-6-6	0.75
WR90	8.20 - 12.4	90-211A-6-6	0.75
WR75	10.0 - 15.0	75-211A-6-6	0.75
WR62	12.4 - 18.0	62-211A-6-6	0.75
WR51	15.0 - 22.0	51-211A-6-6	0.75
WR42	18.0 - 26.5	34-211A-6-6	0.75
WR34	22.0 - 33.0	42-211B-6-6	0.75
WR28	26.5 - 40.0	28-211A-6-6	0.75

WAVEGUIDE FLANGES

- ATM offers products in a broad range of standard and custom flanges
- Both Rectangular and Double Ridge Products are offered
- For detailed flange information and drawings see ATM WEB
<http://www.atmmicrowave.com/AtmFlanges.html>

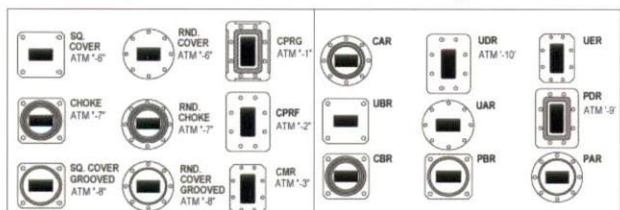

*North American EIA Standard Flanges

*European IEC Standard Flanges

KA-BAND SATCOM COMPONENTS

Downlink 18.3-20.2 GHz, Uplink 27.5-31.0 GHz, Full 18.3-31.0 GHz

ATM offers both Coaxial and Waveguide Ka-Band specific components that cover the uplink and downlink frequency bands with better specifications and better pricing compared to broad band components. [Go to www.atmmicrowave.com](http://www.atmmicrowave.com) and click on the Ka-Band Component section

KA BAND COMPONENTS



CLICK FOR KA - BAND COMPONENTS



CLICK FOR COAX LINE STRETCHERS

CLICK FOR W/G TO COAX ADAPTER

Ka-WG_Adapter.pdf - Advanced Technical...

Adapters, Waveguide to Coax, Right Angle

ATM manufactures Waveguide to Coax Adapters for the Ka-Band frequency range for the downlink band 18.3-20.2GHz and the uplink band 27.5-31.0GHz. For more information feel free to call us and discuss your needs with one of our design engineers.

GENERAL SPECIFICATIONS - RECTANGULAR WAVEGUIDE TO COAX ADAPTERS

Electrical
 VSWR: Standard Models: 1.21 Max
 Precision Models: 1.12 Max
 RF Connectors: K-Type, SMA available

Mechanical
 Body: Aluminum/Copper-Brass (per order)
 Flanges: Multiple types available - see ATM Std. Flanges
 Operation Temp: Finish: Unique corrosion resistant 316 stainless steel epoxy coating IAW MIL-F-14072
 Options: Pressure seal Units: Units sealed to hold 10 psi. Add "PT" to model number. example: P1N 51ka-251B-6 sealed becomes: 51ka-251B-6-PT

WG Size	Freq (GHz)	Model No.*	Coax Connector	VSWR (Max.)	Power CW (Watts)	Peak Power (kW)	Theoretical L.L. (Max.)***	Outline Drawing
WR51	18.3 - 20.2	51ka-251B-6	SMA-female	1.21	50	3	0.29	Dwg
WR51	18.3 - 20.2	51ka-25K-6	Type K-Female	1.21	50	3	0.29	Dwg
WR42	18.3 - 20.2	42ka-251B-6	SMA-female	1.21	50	3	0.32	Dwg
WR42	18.3 - 20.2	42ka-25K-6	Type K-Female	1.21	50	3	0.32	Dwg
WR34	27.5 - 31.0	34ka-25KB-6	Type-K female	1.21	10	3	0.35	Dwg
WR28	27.5 - 31.0	28ka-25KA-6	Type-K female	1.21	10	3	0.30	Dwg

WG Size	Freq (GHz)	Model No.*	Coax Connector	VSWR (Max.)	Power CW (Watts)	Peak Power (kW)	Theoretical L.L. (Max.)***	Outline Drawing
WR51	18.3 - 20.2	51ka-251PVB-6	SMA-female	1.12	50	3	0.29	Dwg
WR51	18.3 - 20.2	51ka-25KPB-6	Type K-Female	1.12	50	3	0.29	Dwg
WR42	18.3 - 20.2	42ka-251PVB-6	SMA-female	1.12	50	3	0.32	Dwg
WR42	18.3 - 20.2	42ka-25KPB-6	Type K-Female	1.12	50	3	0.32	Dwg

Ka_Band_Coax_Line_Stretch - Advanced Technical...

Line Stretchers, Ka-Band

ATM now offers Line Stretchers designed specifically for the Ka-Band application. Please call us with your requirements and discuss your needs with one of our design engineers.

P191x Series Line Stretchers, Ka-Band Satcom Models
 Downlink 18.3-20.2GHz, Uplink 27.5-31.0GHz, Full 18.3-31.0GHz

- Smooth continuous phase change.
- Locking Device Included.
- 2.9mm connectors available.

Phase Shift with Frequency

GENERAL SPECIFICATIONS

Electrical
 RF Connectors: 2.9mm (K) F/F
 Impedance: 50 Ohm
 Insertion Phase @ 1.0 GHz: 90° (min. setting)
 RF Power: 50W average, 3kW peak
 Mechanical
 Body: Brass, Nickel Plated
 Connectors: Stainless Steel
 Operating Temp: -54°C to +115°C
 Applicable MIL-Specs
 General:
 Product Specific:

Model No.	Freq GHz	Standard Models	Min Phase Adjust	LL, dB max
P1918Ka	18.3-21.0	TBA	15 /GHz	TBA
P1919Ka	27.5-31.0	TBA	15 /GHz	TBA
P191Ka	18.3-31.0	TBA	15 /GHz	TBA

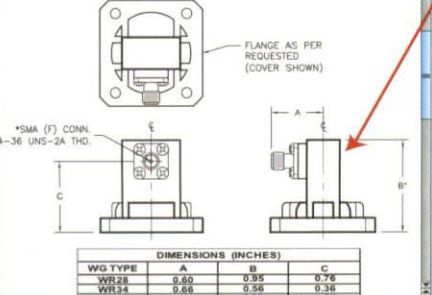

CLICK FOR OUTLINE DRAWING

Instructions for operation of ATM Inc. Line Stretcher P/N P191Z

- Mount Line Stretcher using Mounting Holes provided. (fig. A)
- Tighten Connector Locking Screw (fig. B). This will secure Barrel (fig. C) to Connector (fig. D). Male Connectors @ (fig. D). Torque to rated value.
- Loosen Connector Locking Screw. (fig. B)
- Adjust Line Stretcher to desired phase by rotating Barrel. Clockwise rotation decreases phase.
- When desired phase is achieved, secure setting by tightening Locknut (fig. E) against surface "F" of Barrel. (fig. C)

Important notes about Connector Locking Screw (fig. B)
 This screw should only be tightened while mating and/or un-mating connectors @ (fig. D). Always loosen screw prior to phase adjustment.

ATM builds thousands of components for Commercial, Military and Scientific Satellites, Aircraft & Vacuum Applications

Flight Waveguide

- Thin Wall, Light Weight
- Low Out Gassing
- HI REL, QC & Traceability
- 20 year Life
- Custom



Space Qual Thin Wall WG



Space Qual WR34 Load



3dB Hybrid with WG to Coax Adapter

Vacuum Chambers

- Low Out Gassing
- No Cooling Air
- Water Cooled
- Chill Plates
- Custom or Modified COTS



Machined Water Cooled WG Load



Water Cooled



Water Cooled Bends



Half Height H-Bend

NASA Solar Dynamic Observatory SDO

- Satellite Flight Application
- ATM WR34 3dB Hybrid
- Machined Design 2 Blocks of AL
- Custom
- See latest mission result, click
- http://www.nasa.gov/mission_pages/sdo/main/index.html



Space Qual WR34 Hybrid



NASA SDO

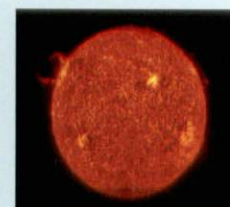

SDO Sun Photo



6 Way Power Divider



Hi Power Coupler with APC7



Direct Reading CVA



Mil Spec Variable Attenuator



Noise Source with ISO



Cell band CVA, SMA or Type N



DC Injectors



Mini Phase Shifter

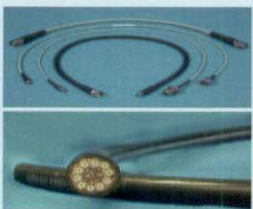

Complex Cable Assemblies



To Spec Form, Fit, and Function CVA'S





WG Arc Detectors



Dual Loop Coupler



Ultra-HP Water Cooled Load



WG Phase Shifter



4-Way WG Power Combiner



Pressurized Wg Assembly



Antenna Feed

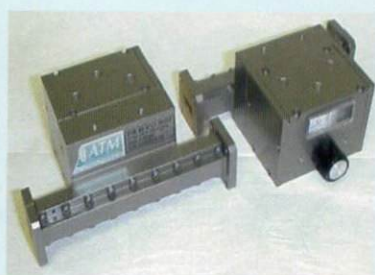

Direct Reading WG CVA

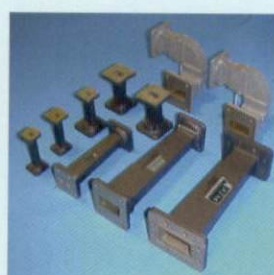

WG To WG Transitions



WR22 CVA



WG HPA Output & Arc Det. Assemblies



Wg Magic Tees



Millimeter WG Triple Arm Coupler



Custom Waveguide Horns



Pole Mount Horn





0.7-18GHz Horn



High Gain Low Frequency Horn



-  ATM ENGINEERING AND MANUFACTURING OPERATIONS
-  ATM SALES OFFICE



PRICES, DELIVERY, TECH SUPPORT

- ATM: Phone, Fax or Sales@atmmicrowave.com
- Local REPS: <http://www.atmmicrowave.com/salesreps>.



HOW TO ORDER

- USA: Send PO to ATM or Email Support@atmmicrowave.com
- USA Credit Card: http://www.atmmicrowave.com/creditcardorder_new.pdf
- Others: <http://www.atmmicrowave.com/ATMfaq.html#A-PlaceOrder>

TERMS and WARRANTY

- <http://www.atmmicrowave.com/ATMTermsandConditions.htm>



49 Rider Ave., Patchogue, New York 11772, USA
Phone (631) 289-0363 Fax (631) 289-0358
E-MAIL: atm@atmmicrowave.com
WEB: www.atmmicrowave.com

