

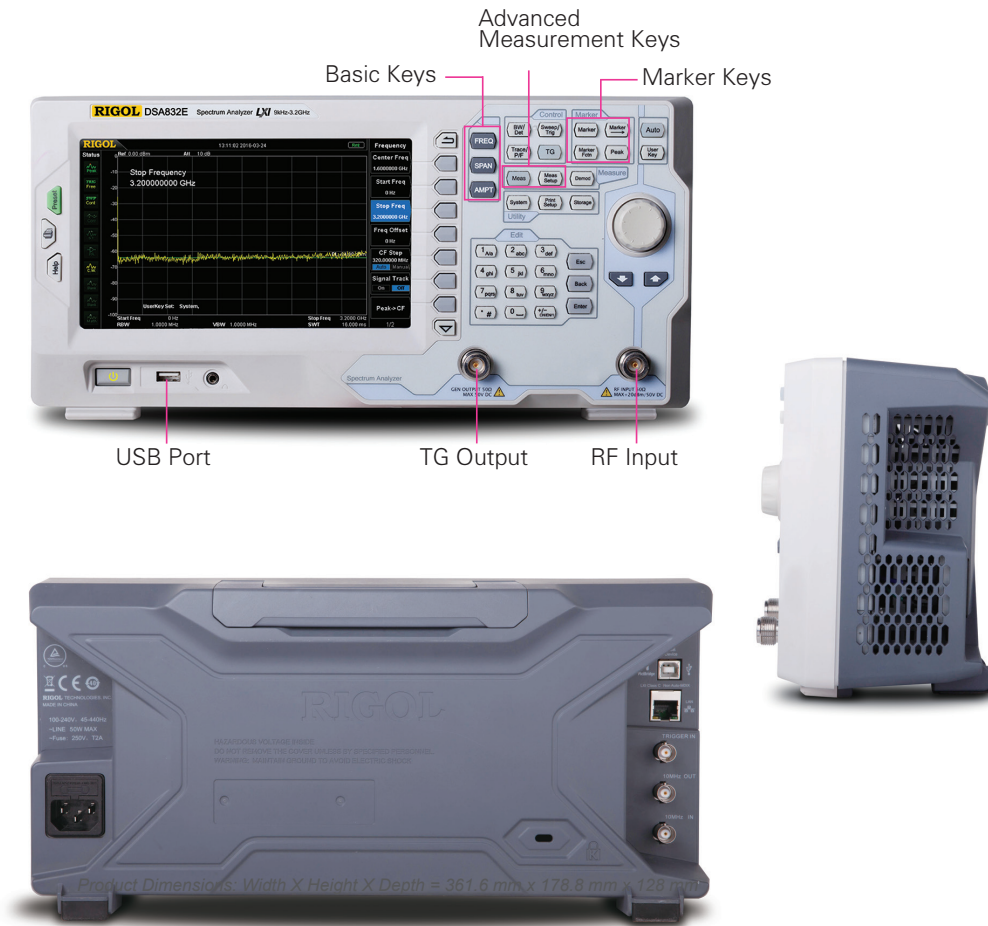

DSA800E Series Spectrum Analyzer

- All-Digital IF Technology
- Frequency Range from 9 kHz to 3.2 GHz
- Min. -148 dBm Displayed Average Noise Level (Typ.)
- Min. <-90 dBc/Hz @ 10 kHz Offset Phase Noise
- Level Measurement Uncertainty <1.0 dB
- 10 Hz Minimum Resolution Bandwidth
- Up to 3.2 GHz Tracking Generator (DSA832E-TG)
- Optional Preamplifier
- Advanced Measurement Functions (Opt.)
- EMI Filter & Quasi-Peak Detector Kit (Opt.)
- VSWR Measurement Kit (Opt.)
- PC Software (Opt.)
- Optional RF TX/RX Training Kit
- Optional RF Accessories (Cable, Adaptor, Attenuator, Bridge ...)
- Complete Connectivity: LAN (LXI), USB Host & Device, GPIB (Opt.)
- 8 Inch WVGA (800×480) Display
- Compact Size, Light Weight Design

DSA800E Series Spectrum Analyzer



Product Dimensions: Width × Height × Depth = 361.6 mm × 178.8 mm × 128 mm

► Benefits of Rigol's all digital IF design

- The ability to measure smaller signals: on the basis of this technology, the IF filter enables smaller bandwidth settings, which greatly reduce the displayed average noise level.
- The ability to distinguish between small signals by frequency: using the IF filter with the smallest bandwidth setting, it is possible to make out signals with a frequency difference of only 10 Hz.
- High precision amplitude readings: this technology almost eliminates the errors generated by filter switching, reference level uncertainty, scale distortion, as well as errors produced in the process of switching between logarithmic and linear display of amplitude when using a traditional analog IF design.
- Higher reliability: compared with traditional analog designs, the digital IF greatly reduces the complexity of the hardware, the system instability caused by channel aging, and the temperature sensitivity that can contribute to parts failure.
- High measurement speed: the use of digital IF technology improves the bandwidth precision and selectivity of the filter, minimizing the scanning time and improving the speed of the measurement.

► Features and Benefits

Distinguish the two nearby signals clearly with the 10 Hz RBW

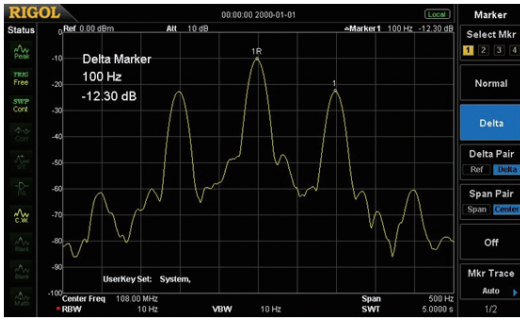

Compare the spectrums with different color trace

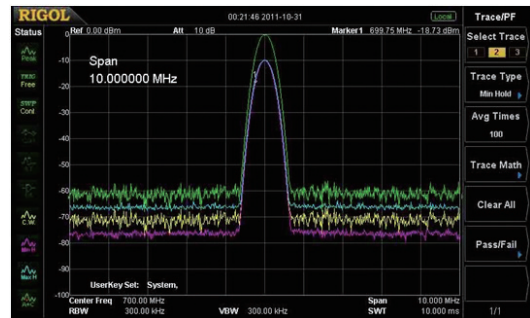

Readout the spectrum peak values with the peak table function

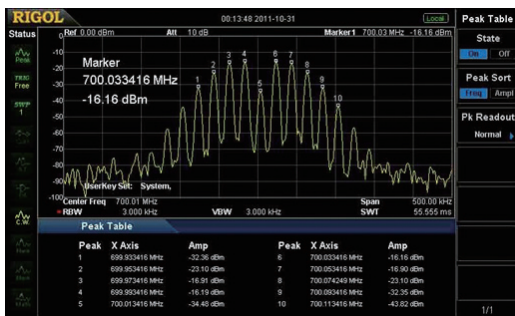

Measure lower level signal with the preamplifier turn on

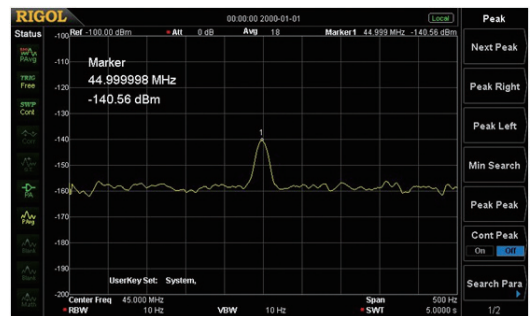

Phase noise < -90 dBc/Hz @10 kHz offset

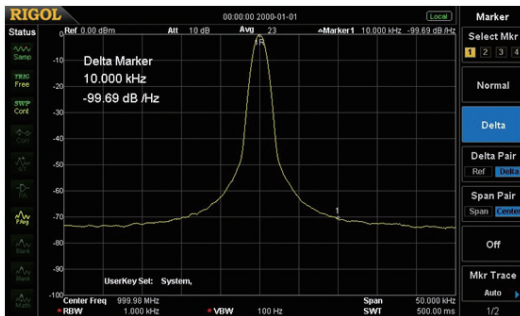

EMI kit (EMI filter & Quasi-peak & Pass/Fail)

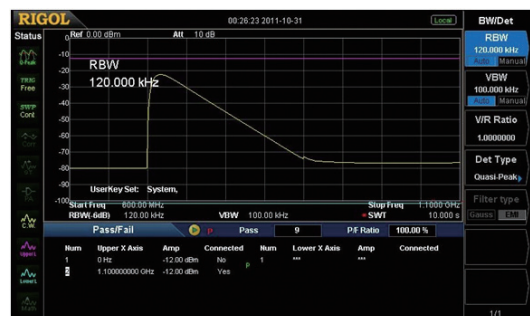

The GUI to control the RF demo kit (Transmitter) directly

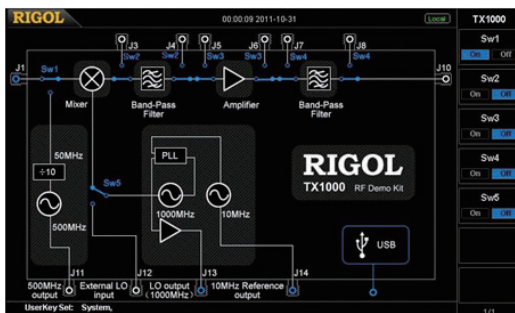

VSWR measurement

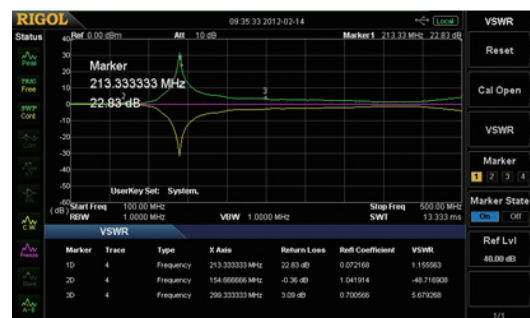

► RIGOL Spectrum Analyzer Option and Accessory

Harmonic Distortion	TOI	Emission Bandwidth
Channel Power	Occupied Bandwidth	
Time Domain Power	Carrier to Noise Ratio	
Adjacent Channel Power	Pass/Fail	

Advanced Measurement Kit
(AMK-DSA800)

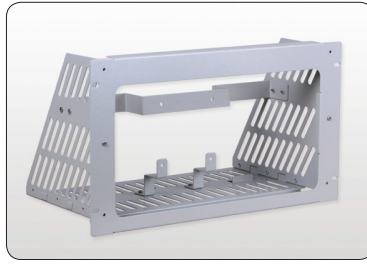

Rack Mount Kit
(RM-DSA800)

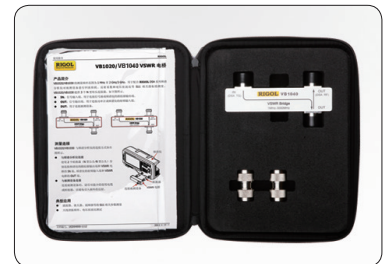

VSWR Bridge
(VB1020/VB1032/VB1040/VB1080)

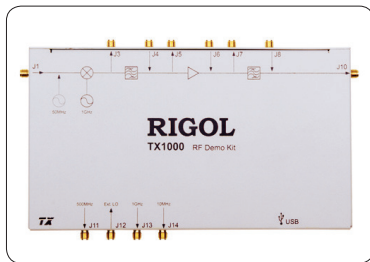

RF Demo Kit
(TX1000)

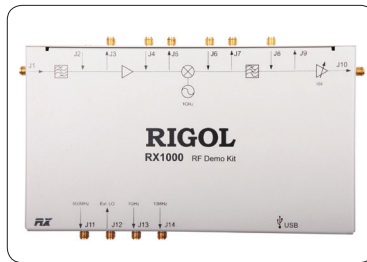

RF Demo Kit
(RX1000)



RF CATV Kit



DSA Utility Kit



RF Adaptor Kit



RF Attenuator Kit



RF Cable Kit
(CB-NM-NM-75-L-12G)
(CB-NM-SMAM-75-L-12G)



High Power Attenuator
(ATT03301H)

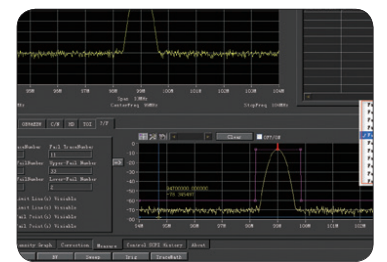

DSA PC Software
(Ultra Spectrum)



USB to GPIB Converter
(USB-GPIB)

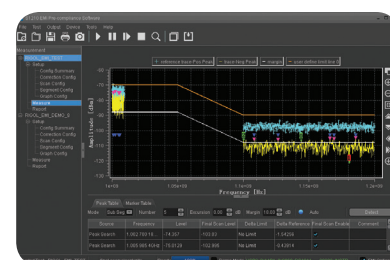

EMI Pre-compliance Test Software
(S1210 EMI Pre-compliance Software)



Near Field Probe
(NFP-3)

► Specifications

Specifications are valid under the following conditions: the instrument is within the calibration period, is stored for at least two hours at 0 °C to 50 °C temperature, and is warmed up for 40 minutes. Unless otherwise noted, the specifications in this manual include the measurement uncertainty.

Typical (typ.): characteristic performance, which 80 percent of the measurement results will meet at room temperature (approximately 25°C). This data is not warranted and does not include the measurement uncertainty.

Nominal (nom.): the expected mean or average performance or a designed attribute (such as the 50Ω connector). This data is not warranted and is measured at room temperature (approximately 25°C).

Measured (meas.): an attribute measured during the design phase which can be compared to the expected performance, such as the amplitude drift variation with time. This data is not warranted and is measured at room temperature (approximately 25°C).

NOTE: All charts in this manual are the measurement results of multiple instruments at room temperature unless otherwise noted. The specifications (except the TG specifications) listed in this manual are those when the tracking generator is off.

Frequency

Frequency	
	DSA832E
Frequency range	9 kHz to 3.2 GHz
Frequency resolution	1 Hz

Internal Reference Frequency	
Reference frequency	10 MHz
Accuracy	$\pm[(\text{time since last calibration} \times \text{aging rate}) + \text{temperature stability} + \text{calibration accuracy}]$
Initial calibration accuracy	<1 ppm
Temperature stability	0°C to 50°C , reference to 25°C
	<1 ppm
Aging rate	<2 ppm/year

Frequency Readout Accuracy	
Marker resolution	span/ (number of sweep points - 1)
Marker uncertainty	$\pm(\text{frequency indication} \times \text{reference frequency accuracy} + 1\% \times \text{span} + 10\% \times \text{resolution bandwidth} + \text{marker resolution})$

Frequency Counter	
Resolution	1 Hz, 10 Hz, 100 Hz, 1 kHz, 10 kHz, 100 kHz
Uncertainty	$\pm(\text{frequency indication} \times \text{reference frequency accuracy} + \text{counter resolution})$

Frequency Span	
Range	0 Hz, 100 Hz to maximum frequency of instrument
Uncertainty	$\pm\text{span}/ (\text{number of sweep points} - 1)$

SSB Phase Noise		
	20°C to 30°C , $f_c = 1 \text{ GHz}$	
Carrier offset	10 kHz offset	<-90 dBc/Hz

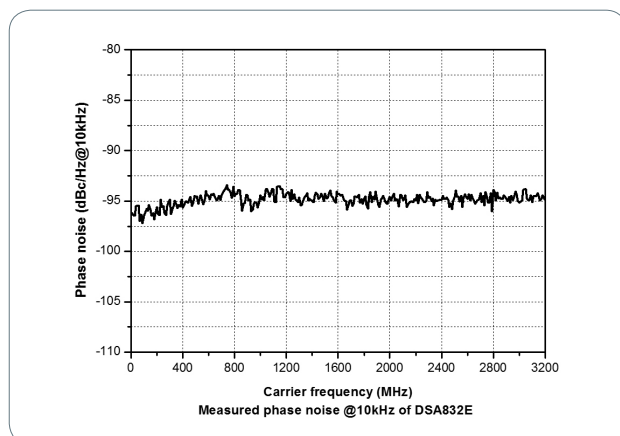

Residual FM	
	20°C to 30°C , RBW = VBW = 1 kHz
Residual FM	<20 Hz (nom.)
Bandwidths	
	Set "Auto SWT" to "Accy"
Resolution bandwidth (-3 dB)	10 Hz to 1 MHz, in 1-3-10 sequence
RBW uncertainty	<5% (nom.)
Resolution filter shape factor (60 dB : 3 dB)	<5 (nom.)
Video bandwidth (-3 dB)	1 Hz to 3 MHz, in 1-3-10 sequence
Resolution bandwidth (-6 dB) (EMI-DSA800 option)	200 Hz, 9 kHz, 120 kHz

Amplitude

Measurement Range	
Range	$f_c \geq 10$ MHz DANL to +20 dBm

Maximum Input Level	
DC voltage	50 V
CW RF power	attenuation = 30 dB +20 dBm (100 mW)
Max. damage level ^[1]	+30 dBm (1 W)

NOTE: [1] When $f_c \geq 10$ MHz, input level > +25 dBm and PA is Off, the protection switch will be on.

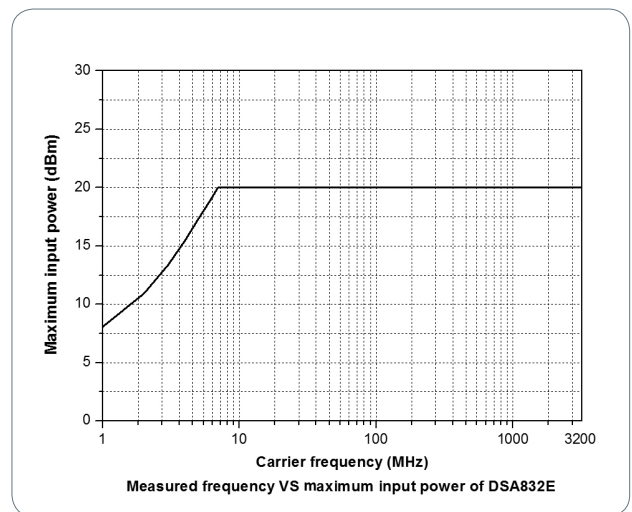
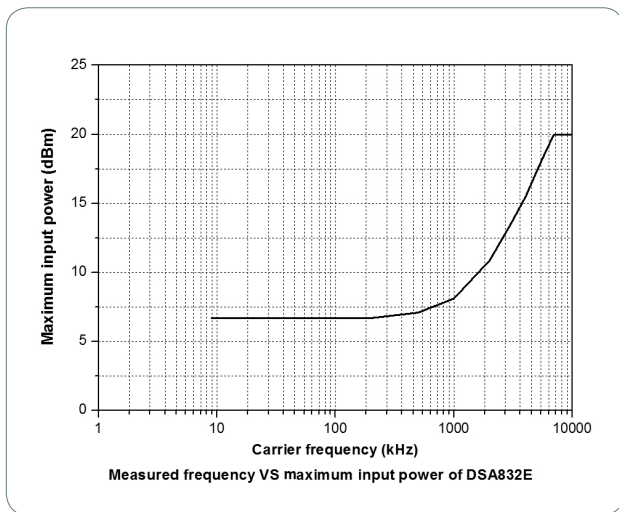

Displayed Average Noise Level (DANL)		
	attenuation = 0 dB, RBW = VBW = 10 Hz, sample detector, trace average ≥ 50 , tracking generator off, 20°C to 30°C , input impedance = 50 Ω	
PA off	9 kHz to 100 kHz	<-110 dBm (typ.)
	100 kHz to 5 MHz	<-122 dBm, <-125 dBm (typ.)
	5 MHz to 3.2 GHz	<-127 dBm, <-130 dBm (typ.)
PA on	100 kHz to 1 MHz	<-142 dBm (typ.)
	1 MHz to 5 MHz	<-140 dBm, <-143 dBm (typ.)
	5 MHz to 3.2 GHz	<-145 dBm, <-148 dBm (typ.)

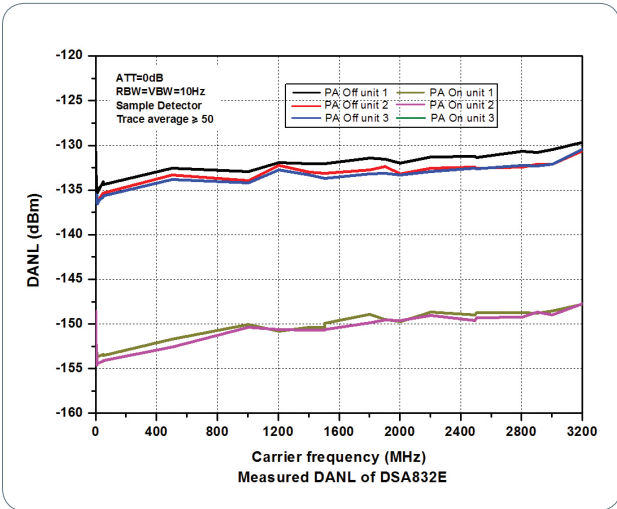

Level Display	
Logarithmic level axis	1 dB to 200 dB
Linear level axis	0 to reference level
Number of display points	601
Number of traces	3 + math trace
Trace detectors	normal, positive-peak, negative-peak, sample, RMS, voltage average quasi-peak (with EMI-DSA800 option)
Trace functions	clear write, max hold, min hold, average, view, blank
Units of level axis	dBm, dBmV, dBμV, nV, μV, mV, V, nW, μW, mW, W

Frequency Response	
	$f_c \geq 100$ kHz, attenuation = 10 dB, relative to 50 MHz, 20°C to 30°C
PA off	100 kHz to 3.2 GHz <0.7 dB
	$f_c \geq 1$ MHz, attenuation = 10 dB, relative to 50 MHz, 20°C to 30°C
PA on	100 kHz to 3.2 GHz <1.0 dB

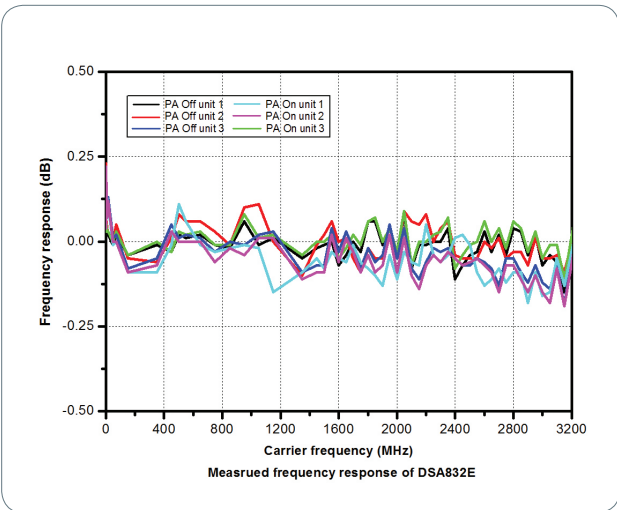

Input Attenuation Switching Uncertainty	
Setting range	0 dB to 30 dB, in 1 dB step
Switching uncertainty	$f_c = 50$ MHz, relative to 10 dB, 20°C to 30°C <0.3 dB

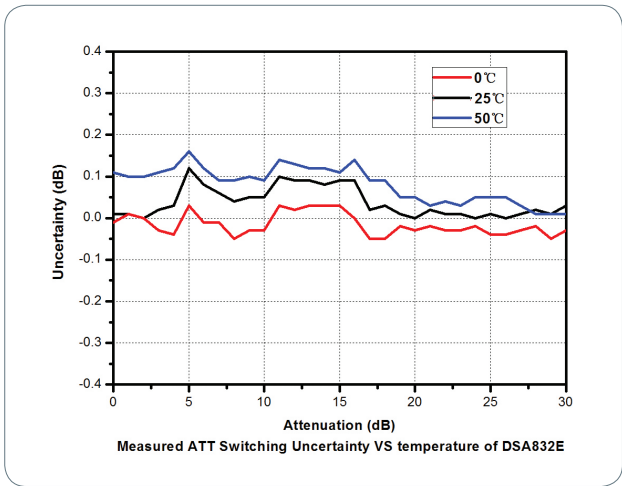

Absolute Amplitude Uncertainty

Uncertainty	$f_c = 50$ MHz, peak detector, preamplifier off, attenuation = 10 dB, input signal level = -10dBm, 20°C to 30°C
	<0.3 dB

RBW Switching Uncertainty

Uncertainty	relative to 1 kHz RBW
	<0.1 dB

Reference Level

Range	-100 dBm to +20 dBm, in 1 dB step	
Resolution	log scale	0.01 dB
	linear scale	4 digits

Preamplifier

	PA-DSA832 (option)	
Gain	100 kHz to 3.2 GHz	17 dB (nom.)

Level Measurement Uncertainty

	95% confidence level, S/N > 20 dB, RBW = VBW = 1 kHz, preamplifier off, attenuation = 10 dB, -50 dBm < input level ≤ 0 dBm, $f_c > 10$ MHz, 20°C to 30°C	
Level measurement uncertainty	<1.0 dB (nom.)	

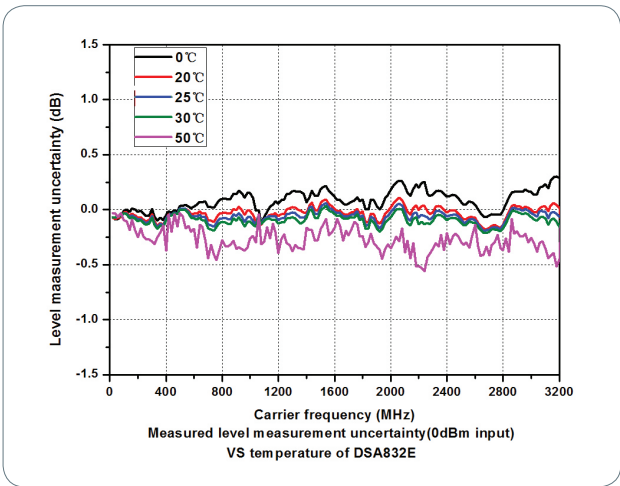

RF Input VSWR		
	attenuation ≥ 10 dB	
VSWR	300 kHz to 3.2 GHz	<1.5 (nom.)

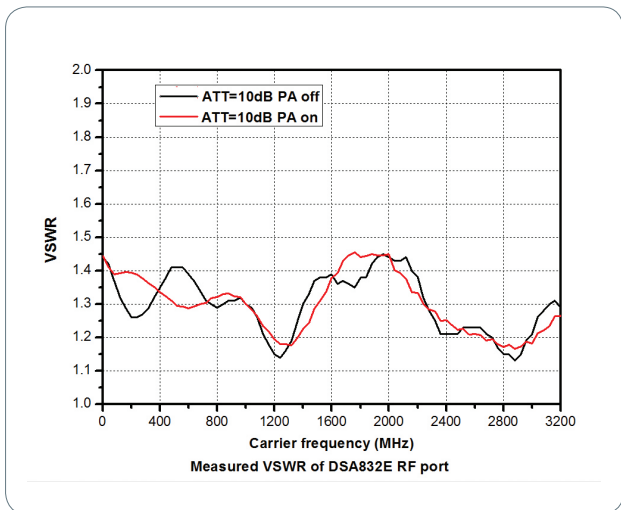

Distortion

Second Harmonic Intercept		
Second harmonic intercept (SHI)	$f_c \geq 50$ MHz, input signal level = -20 dBm, attenuation = 10 dB	
	+40 dBm	
Third-order Intercept		
Third-order intercept (TOI)	$f_c \geq 50$ MHz, two -20 dBm tones at input mixer spaced by 200 kHz, attenuation = 10 dB	
	+7 dBm	
1dB Gain Compression		
1dB compression of input mixer (P_{1dB})	$f_c \geq 50$ MHz, attenuation = 0 dB	
	>0 dBm	

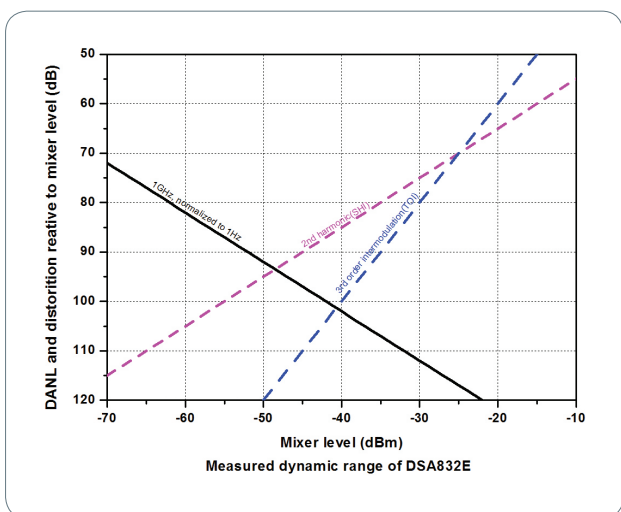

Spurious Response	
Spurious response, inherent	input terminated 50 Ω , attenuation = 0 dB, 20°C to 30°C <-90 dBm ^[2] , <-100 dBm (typ.)
Intermediate frequency	<-60 dBc
System related sidebands	referenced to local oscillators, referenced to A/D conversion, referenced to subharmonic of first LO, referenced to harmonic of first LO <-60 dBc
Input related spurious	mixer level = -30dBm <-60 dBc

NOTE: [2] Except the internal local oscillator (1820 MHz) and its harmonics.

Sweep

Sweep		
Sweep time	span \geq 100 Hz	1 ms to 3200 s
	zero span	20 μ s to 3200 s
Sweep time uncertainty	span \geq 100 Hz	5% (nom.)
	zero span (sweep time setting value > 1 ms)	5% (nom.)
Sweep mode	continuous, single	

Tracking Generator (Option)

TG Output	
Frequency range	100 kHz to 3.2 GHz
Output level range	-40 dBm to 0 dBm
Output level resolution	1 dB
Output flatness	relative to 50 MHz \pm 3 dB (nom.)

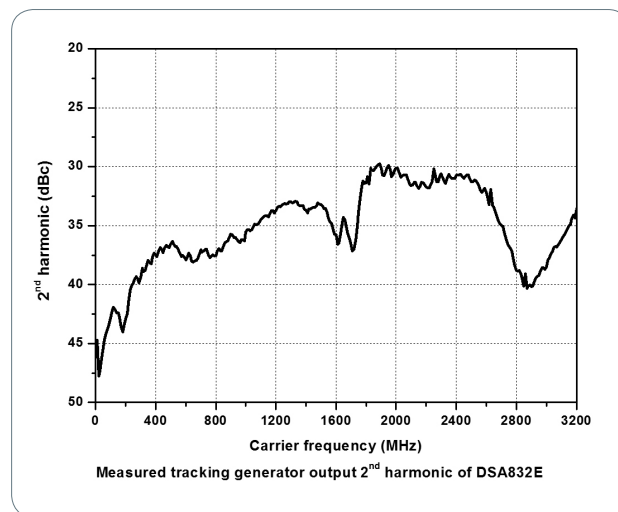
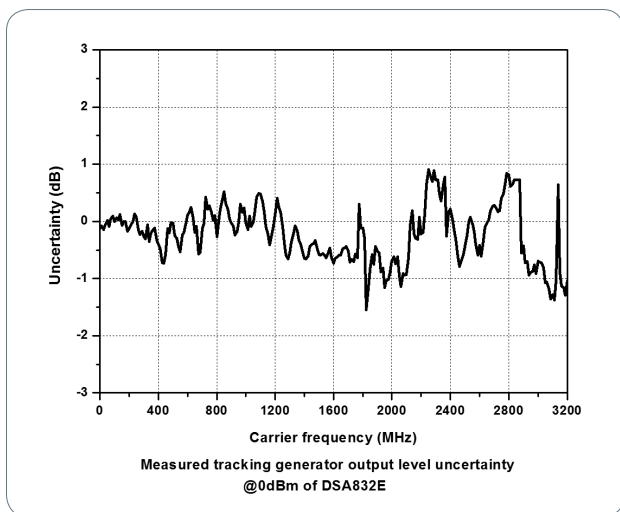

Trigger

Trigger	
Trigger source	Trigger source
External trigger level	External trigger level

Input /Output

Front Panel Connectors		
RF input	impedance	50 Ω (nom.)
	connector	N female
Tracking generator output	impedance	50 Ω (nom.)
	connector	N female

Internal/ External Reference		
Internal reference	frequency	10 MHz
	output level	+3 dBm to +10 dBm, +8 dBm (typ.)
	impedance	50 Ω (nom.)
	connector	BNC female
External reference	frequency	10 MHz \pm 5 ppm
	input level	0 dBm to +10 dBm
	impedance	50 Ω (nom.)
	connector	BNC female

External Trigger Input		
External trigger input	impedance	1 k Ω (nom.)
	connector	BNC female

Communication Interface		
USB host	connector	A plug
	protocol	version2.0
USB device	connector	B plug
	protocol	version2.0
LAN	LXI core 2011 device	10/100Base, RJ-45
IEC/IEEE (GPIB) bus (USB-GPIB option)		IEEE488.2

General Specifications

Display	
Type	TFT LCD
Resolution	800 x 480 pixels
Size	8 inch
Colors	64k

Printer Supported	
Protocol	PictBridge

Mass Memory	
Mass memory	flash disk (internal), USB storage device (not supplied)

Power Supply	
Input voltage range, AC	100 V to 240 V (nom.)
AC supply frequency	45 Hz to 440 Hz
Power consumption	35 W (typ.), max. 50 W with all options

Environmental		
Temperature	operating temperature range	0°C to 50°C
	storage temperature range	-20°C to 70°C
Humidity	0°C to 30°C	\leq 95% rel. humidity
	30°C to 40°C	\leq 75% rel. humidity
Altitude	operating height	up to 3,000m

Electromagnetic Compatibility and Safety		
EMC	in line with EN61326-1:2006	
	IEC 61000-4-2:2001	\pm 4.0 kV (contact discharge), \pm 4.0 kV (air discharge)
	IEC 61000-4-3:2002	3 V/m (80 MHz to 1 GHz), 3 V/m (1.4 GHz to 2 GHz), 1 V/m (2.0 GHz to 2.7 GHz)
	IEC 61000-4-4:2004	1 kV power lines
	IEC 61000-4-5:2001	0.5 kV (phase to neutral), 0.5 kV (phase to PE), 1 kV (neutral to PE)
	IEC 61000-4-6:2003	3 V, 0.15 to 80 MHz
	IEC 61000-4-11:2004	voltage dip: 0% UT during half cycle, 0% UT during 1 cycle, 70% UT during 25 cycles short interruption: 0% UT during 250 cycles

Electrical safety	in line with UL 61010-1:2012, CAN/CSA-C22.2 No. 61010-1-12, EN 61010-1:2010
Dimensions	
(W x H x D)	361.6 mm x 178.8 mm x 128 mm (14.2 in x 7.0 in x 5.0 in)
Weight	
Standard	4.55 kg (10.0 lb)
With tracking generator	5.15 kg (11.4 lb)
Calibration Interval	
Recommended calibration interval	1 year

► Ordering Information

	Description	Order Number
Model	spectrum analyzer, 9 kHz to 3.2 GHz	DSA832E
	spectrum analyzer, 9 kHz to 3.2 GHz (with tracking generator, factory installed)	DSA832E-TG
Standard accessories	quick guide (hard copy)	-
	power cable	-
Options	preamplifier, 100 kHz to 3.2 GHz	PA-DSA832
	EMI filter & quasi-peak detector	EMI-DSA800
	advanced measurement kit	AMK-DSA800
	VSWR measurement kit	VSWR-DSA800
	DSA PC software	Ultra Spectrum
Optional accessories	include: N-SMA cable, BNC-BNC cable, N-BNC adaptor, N-SMA adaptor, 75 Ω to 50 Ω adaptor, 900 MHz/1.8 GHz antenna (2pcs), 2.4 GHz antenna (2pcs)	DSA Utility Kit
	include: N(F)-N(F) adaptor (1pcs), N(M)-N(M) adaptor (1pcs), N(M)-SMA(F) adaptor (2pcs), N(M)-BNC(F) adaptor (2pcs), SMA(F)-SMA(F) adaptor (1pcs), SMA(M)-SMA(M) adaptor (1pcs), BNC T type adaptor (1pcs), 50 Ω SMA load (1pcs), 50 Ω BNC impedance adaptor (1pcs)	RF Adaptor Kit
	include: 50 Ω to 75 Ω adaptor (2pcs)	RF CATV Kit
	include: 6dB attenuator (1pcs), 10dB attenuator (2pcs)	RF Attenuator Kit
	30dB high power attenuator, max. power 100W	ATT03301H
	N(M)-N(M) RF cable	CB-NM-NM-75-L-12G
	N(M)-SMA(M) RF cable	CB-NM-SMAM-75-L-12G
	RF demo kit (transmitter)	TX1000
	RF demo kit (receiver)	RX1000
	VSWR bridge, 1 MHz to 2 GHz	VB1020
	VSWR bridge, 1 MHz to 3.2 GHz	VB1032
	VSWR bridge, 800 MHz to 4 GHz	VB1040
	VSWR bridge, 2 GHz to 8 GHz	VB1080
	near field probe	NFP-3
	EMI Pre-compliance test software	S1210 EMI Pre-compliance Software
	rack mount kit	RM-DSA800
	soft carrying bag	BAG-G1
	USB cable	CB-USBA-USBB-FF-150
	USB to GPIB interface converter for instrument	USB-GPIB



HEADQUARTER

RIGOL TECHNOLOGIES, INC.
No.156,Cai He Village,
Sha He Town,
Chang Ping District, Beijing,
102206 P.R.China
Tel: +86-10-80706688
Fax: +86-10-80705070
Electronic Measurement
Instrument service and support
email:EMD_support@rigol.com

EUROPE

RIGOL TECHNOLOGIES GmbH
Lindbergh str. 4
82178 Puchheim
Germany
Tel: 0049- 89/89418950
Email: info-europe@rigoltech.com

NORTH AMERICA

RIGOL TECHNOLOGIES,
USA INC.
10200 SW Allen Blvd, Suite C
Beaverton, OR 97005, USA
Toll free: 877-4-RIGOL-1
Office: (440) 232-4488
Fax: (216)-754-8107
Email: info@rigol.com

JAPAN

RIGOL TECHNOLOGIES JAPAN G.K.
Tonematsu Bldg. 5F, 2-33-8 Nihonbashi-
Ningyocho, Chuo-ku,
Tokyo 103-0013
Japan
Tel: +81-3-6264-9251
Fax: +81-3-6264-9252
Email: info-japan@rigol.com

RIGOL® is the registered trademark of **RIGOL** Technologies, Inc. Product information in this document subject to update without notice. For the latest information about **RIGOL**'s products, applications and services, please contact local **RIGOL** office or access **RIGOL** official website: www.rigol.com

